



*Encyclopedia of
Unarmed and
Hand to Hand Combat!*

Deal the First DEADLY BLOW!





DEAL THE FIRST DEADLY BLOW

		Paragraph	Page
PART	ONE.	INSTINCTIVE RIFLE-BAYONET FIGHTING	
CHAPTER	1.	RIFLE-BAYONET FIGHTING TECHNIQUES	
Section	I.	Introduction -----	1-4 1
	II.	Positions -----	5, 6 2
	III.	Movements -----	7-12 3
CHAPTER	2.	TRAINING FOR RIFLE-BAYONET FIGHTING	
Section	I.	Training facilities -----	13-15 19
	II.	Preparation for training -----	16-21 23
	III.	Method of training -----	22-26 24
CHAPTER	3.	PUGIL TRAINING	
Section	I.	Introduction -----	27-29 29
	II.	Conduct of pugil training -----	30-32 31
	III.	Pugil courses -----	33, 34 32
CHAPTER	4.	PUGIL EQUIPMENT	
Section	I.	Introduction -----	35, 36 33
	II.	Protective equipment and stick -----	37-40 33
PART	TWO.	HAND-TO-HAND COMBAT	
CHAPTER	5.	INTRODUCTION TO HAND-TO-HAND COMBAT	
Section	I.	Introduction -----	41, 42 43
	II.	Principles -----	43-46 44
	III.	Vulnerable points -----	47-50 44
	IV.	Available weapons -----	51-53 46
	V.	Training -----	54-63 48
CHAPTER	6.	BASIC HAND-TO-HAND COMBAT	
Section	I.	Introduction -----	64-66 51
	II.	Basic positions and movements -----	67-69 51
	III.	Methods of attack -----	70-81 55
	IV.	Counters -----	82-92 65
	V.	Bayonet parries and defense against knife attack -----	93, 94 73
CHAPTER	7.	ADVANCED HAND-TO-HAND COMBAT	
Section	I.	Introduction -----	95-97 77
	II.	Fall positions -----	98-105 77
	III.	Takedowns and throws -----	106-112 83
	IV.	Bayonet disarming -----	113-116 89
	V.	Knife attack and defense -----	117-123 94
CHAPTER	8.	SPECIALIZED SKILLS	
Section	I.	Introduction -----	124, 125 103
	II.	Hold and counters to holds -----	126-141 103
	III.	Variations to throws and takedowns -----	142-144 116
	IV.	Sentry silencing -----	145-150 119
	V.	Prisoner searching and securing -----	151-166 125
APPENDIX	A.	REFERENCES -----	137
	B.	BAYONET ASSAULT COURSE -----	139
INDEX		-----	155

DESERT PUBLICATIONS
Cornville, Arizona 86325

ISBN: 0-87947-421-X

PART ONE

INSTINCTIVE RIFLE-BAYONET FIGHTING

CHAPTER 1

RIFLE-BAYONET FIGHTING TECHNIQUES

Section 1. INTRODUCTION

1. Purpose and Scope

a. This manual contains information and guidance pertaining to *rifle-bayonet fighting* and *hand-to-hand combat*. Part one contains information on the following: rifle-bayonet fighting techniques, positions, movements, training facilities, training guidance, pugil training and pugil equipment. Part two contains information on armed and unarmed hand-to-hand combat to include techniques, vulnerable points, available weapons, training methods, and offensive movements and counters; these are divided into basic, advanced, and specialized skills. The material presented is applicable to both nuclear and nonnuclear warfare.

b. Part one of the manual is a guide for instructors to use to prepare themselves to conduct training of soldiers in the art of instinctive rifle-bayonet fighting. It explains the uses of rifle-bayonet techniques and describes the basic techniques, positions, and training facilities necessary for safe and realistic training.

c. Users of this publication are encouraged to submit recommended changes or comments to improve the publication. Comments should be keyed to the specific page, paragraph, and line of the text in which the change is recommended. Reasons should be provided for each comment to insure understanding and complete evaluation. Comments should be prepared using DA Form 2028 (Recommended Changes to Publications) and forwarded to the Commandant, United States Army Infantry School, Fort Benning, Ga. 31905.

2. Users of the Bayonet

a. New weapons, improved equipment, and new tactics have been introduced into modern warfare; however, firepower alone will not always drive a determined enemy from his position. He will often remain in defense emplacements until driven out

by close combat. The role of the soldier, particularly in the final phase of the assault, remains relatively unchanged: His mission is to close with and disable or capture the enemy. This mission remains the ultimate goal of all individual training. The rifle with fixed bayonet is one of the final means of defeating an opponent in an assault.

b. During infiltration missions at night, or when secrecy must be maintained, the bayonet is an excellent silent weapon.

c. When close-in fighting determines the use of small arms fire or grenades to be impractical, or when the situation does not permit the loading or reloading of the rifle, the bayonet is still the weapon available to the soldier.

d. The bayonet serves as a secondary weapon should the rifle develop a stoppage.

e. In hand-to-hand encounters the bayonet may be used as a hand-held weapon.

f. Finally, the bayonet is a multipurpose weapon and has many non-fighting uses, such as a probe for mines, to cut vegetation, and other tasks where a pointed or cutting tool can be employed.

3. Developing a Rifle-Bayonet Fighter

a. To become a successful rifle-bayonet fighter, a soldier must be physically fit and mentally alert. A well-rounded physical training program will increase his chances of survival in a bayonet encounter. Mental alertness entails being able to quickly detect and meet an opponent's attack from any direction.

b. Aggressiveness, accuracy, balance, and speed are essential in training as well as in combat situations. These traits lead to confidence, coordination, strength, and endurance, which characterize the rifle-bayonet fighter. Differences in individual body physique may require slight changes from the

rifle-bayonet techniques described in this manual; variations in technique will be allowed if the individual's attack is effective.

4. Principles of Rifle-Bayonet Fighting

a. The bayonet is an effective weapon to be used aggressively; hesitation may mean sudden death. The soldier must attack in a relentless assault until his opponent is disabled or captured. He should be alert to take advantage of any opening. If the opponent fails to present an opening, the bayonet fighter must make one by parrying his opponent's weapon, and then drive his blade or rifle butt into the opponent with force.

b. The attack should be made to a vulnerable portion of the body: the face, throat, chest, abdomen, or groin.

c. In both training and combat, the rifle-bayonet fighter displays spirit by sounding off with a loud and aggressive growl. This instills a feeling of confidence in his ability to close with and disable or capture the enemy with his rifle-bayonet.

d. The instinctive rifle-bayonet fighting system is designed to capitalize on the natural agility and combative movements of the soldier.

e. It must be emphasized that precise learned movements will *NOT* be stressed during training.

Section II. POSITIONS

5. General

a. The soldier holds the rifle firmly but without tenseness, and relaxes all muscles not used in a particular position. Tense muscles cause fatigue and may tend to slow him down. After proper training, and through practice, the soldier will instinctively assume the basic positions.

b. All positions and movements described in this manual are for right-handed men. A left-handed man, or a man who desires to learn left-handed techniques, must use the opposite hand and foot for each phase of the movement described.

c. Illustrations in this manual show the M16A1 rifle with the sling tightened. All positions and movements, however, can be executed with or without the magazine and with the sling tightened or loose. The movements are also applicable to the M14 rifle.

6. Basic Attack and Rest Positions

a. *Attack Position (Fig. 1).*

(1) *Objective and use.* This is the basic starting position from which all attack movements originate. It generally parallels a boxer's stance. The soldier will assume this position when running or hurdling obstacles.

(2) *Execution (the instructor explains and demonstrates).*

(a) TAKE A SHORT STEP FORWARD AND TO THE SIDE WITH YOUR LEFT FOOT SO THAT YOUR FEET ARE A COMFORTABLE DISTANCE APART.

(b) HOLD YOUR BODY ERECT OR BEND SLIGHTLY FORWARD AT THE WAIST. YOUR KNEES ARE FLEXED AND YOUR BODY WEIGHT IS BALANCED ON THE BALLS OF YOUR FEET. YOUR RIGHT FOREARM IS APPROXIMATELY PARALLEL TO

THE GROUND. THE LEFT ARM IS HELD HIGH, GENERALLY IN FRONT OF THE LEFT SHOULDER. MAINTAIN EYE-TO-EYE CONTACT WITH YOUR OPPONENT, WATCHING HIS WEAPON AND BODY THROUGH PERIPHERAL VISION.



Figure 1. Attack position.



Figure 1—Continued.

(c) YOUR RIFLE IS HELD DIAGONALLY ACROSS YOUR BODY AT A SUFFICIENT DISTANCE FROM THE BODY TO ADD

BALANCE AND PROTECT YOU FROM ENEMY BLOWS. YOUR LEFT HAND IS GRASPING THE WEAPON JUST BELOW THE UPPER SLING SWIVEL AND THE RIGHT HAND IS AT THE SMALL OF THE STOCK. THE SLING IS FACING OUTWARD AND THE CUTTING EDGE OF THE BAYONET IS TOWARD YOUR OPPONENT. BALANCE IS MOST IMPORTANT. POSITIONS MAY VARY WITH EACH SOLDIER DUE TO CONFIGURATION OF THE BODY.

(3) *Command.* The command used to assume the attack position is ATTACK POSITION MOVE.

(4) *Performance.* Instructor gives command and men perform movement.

b. *Relax Position (Fig. 2).*

(1) *Objective and use.* The relax position is used to give the soldier a chance to rest during training. It also allows him to direct his attention toward the instructor as he discusses and demonstrates the positions and movements.

(2) *Execution (the instructor explains and demonstrates).* TO ASSUME THE RELAX POSITION FROM THE ATTACK POSITION, STRAIGHTEN THE WAIST AND KNEES AND LOWER THE RIFLE ACROSS THE FRONT OF YOUR BODY BY EXTENDING THE ARMS DOWNWARD.

(3) *Command.* The command used to assume the relax position is RELAX.

(4) *Performance.* Instructor gives command and men perform movement.

Section III. MOVEMENTS

7. General

The soldier will instinctively strike at openings and become aggressive in his attack once he has learned to relax and has developed instinctive reflexes. His movements do not have to be executed in any prescribed order. He will achieve balance in his movements, be ready to strike in any direction, and keep striking until he has disabled his opponent. The movements explained in this section are basic to the rifle-bayonet fighter.

8. Basic Movements

There are two basic movements used throughout bayonet instruction. They are the whirl and the crossover movements. These movements develop instant reaction to commands and afford the instructor maximum control of the training formation while on the training field.

a. *Whirl Movement (Fig. 3)*

(1) *Objective and use.* The whirl, properly

executed, allows the rifle-bayonet fighter to meet a challenge from an opponent attacking him from the rear. At the completion of a whirl the rifle remains in the attack position.

(2) *Execution (the instructor explains and demonstrates).* SPIN YOUR BODY AROUND BY PIVOTING ON THE BALL OF THE LEADING FOOT IN THE DIRECTION OF THE LEADING FOOT, THUS FACING COMPLETELY ABOUT.

(3) *Command.* To execute the whirl movement the command is WHIRL.

(4) *Performance.* Instructor gives command and men perform movement.

b. *Crossover Movement.*

(1) *Objective and use.* While performing certain movements in rifle-bayonet training, two ranks will be moving toward each other. When the men in ranks come too close to each other to safely execute additional movements, the crossover is used to separate the ranks a safe distance apart.



Figure 2. Relax position.

(3) *Commands.* The command used to execute the crossover is CROSSOVER.

(4) *Performance.* Instructor gives command and men perform movement.

9. Attack Movements

There are four attack movements designed to disable or capture the opponent. These are the thrust, butt stroke, slash, and smash. Each of these movements may be used for the initial attack or as a followup should the initial movement fail to find its mark. The men learn these movements separately and during subsequent training will learn to execute these movements in a swift and continuous series. During all periods of training, the emphasis will be on conducting natural, balanced movements to effectively damage the target. Precise, learned movements will not be stressed.

a. Thrust (Fig. 4).

(1) *Objective and use.* The objective is to disable or capture an opponent by thrusting the bayonet blade into a vulnerable portion of his body. The thrust is especially effective in areas where movement is restricted, e.g., trenches, woods, or built-up area. It is also effective when an opponent is lying on the ground or in a foxhole.

(2) *Execution (the instructor explains and demonstrates).* LUNGE FORWARD ON YOUR LEADING FOOT WITHOUT LOSING YOUR BALANCE, AND AT THE SAME TIME DRIVE



Figure 3. Whirl movement.

(2) *Execution (the instructor explains and demonstrates).* ON THE COMMAND OF CROSSOVER, MOVE STRAIGHT FORWARD AND PASS YOUR OPPONENT SO THAT YOUR RIGHT SHOULDER PASSES HIS RIGHT SHOULDER. CONTINUE MOVING FORWARD FOR APPROXIMATELY SIX STEPS, HALT, AND WITHOUT COMMAND, EXECUTE THE WHIRL. REMAIN IN THE ATTACK POSITION AND WAIT FOR FURTHER COMMANDS FROM ME.

Note. Left handed personnel cross left shoulder to left shoulder.

THE BAYONET WITH GREAT FORCE INTO ANY UNGUARDED PORTION OF YOUR OPPONENT'S BODY. TO ACCOMPLISH THIS, GRASP THE RIFLE FIRMLY WITH BOTH HANDS AND PULL THE STOCK IN CLOSE TO THE RIGHT HIP; PARTIALLY EXTEND THE LEFT ARM, GUIDING THE POINT OF THE BAYONET IN THE GENERAL DIRECTION OF THE OPPONENT'S BODY. QUICKLY COMPLETE THE EXTENSION OF THE ARMS AND BODY AS THE LEADING FOOT STRIKES THE GROUND SO THAT THE BAYONET PENETRATES THE TARGET. TO

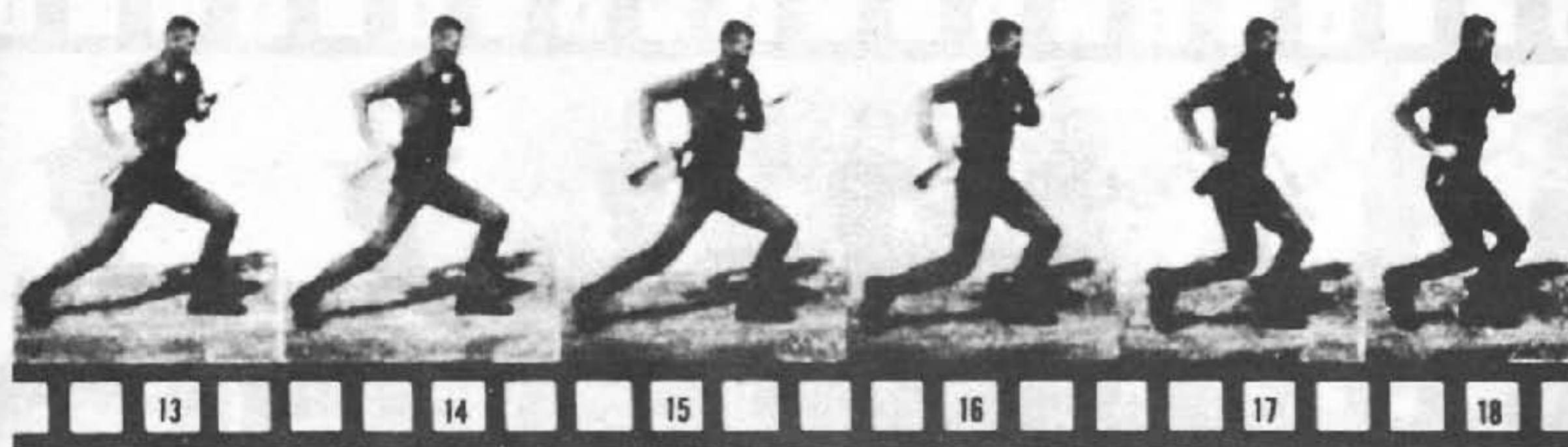
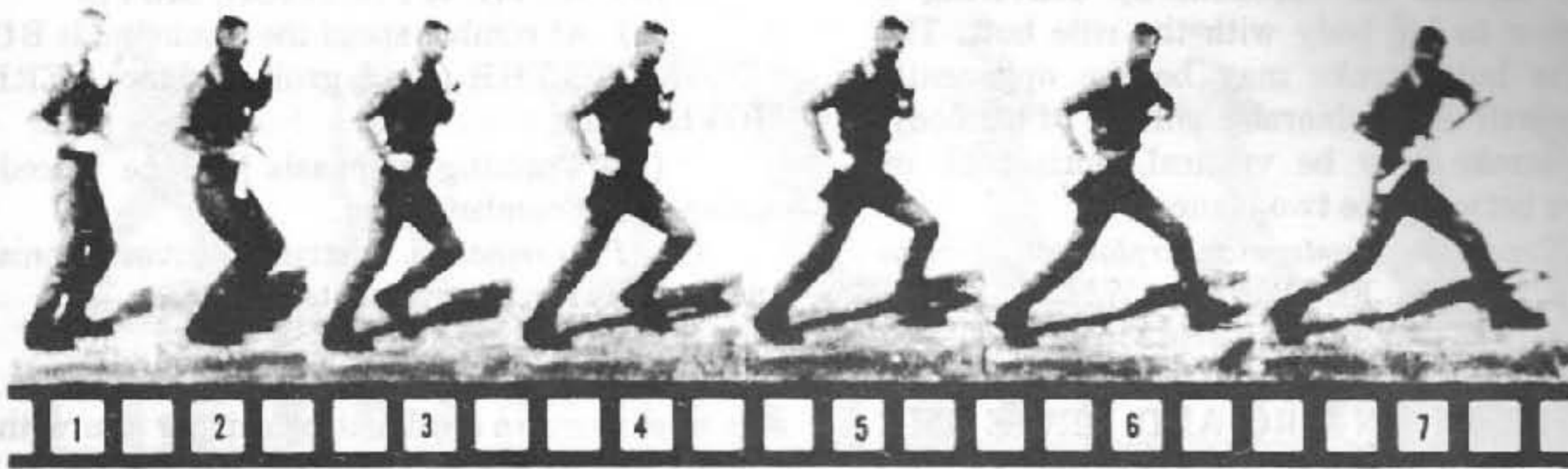

Figure 4. Thrust movement.

WITHDRAW THE BAYONET, KEEP THE FEET IN PLACE, SHIFT YOUR BODY WEIGHT TO THE REAR, AND PULL REARWARD ALONG THE SAME LINE OF PENETRATION; NEXT, ASSUME THE ATTACK POSITION IN PREPARATION TO CONTINUE THE ASSAULT.

(3) *Commands.* This movement is taught by the numbers in three phases:

(a) THRUST AND HOLD, MOVE.

(b) WITHDRAW AND HOLD, MOVE.

(c) ATTACK POSITION, MOVE.

(d) At combat speed the command is THRUST SERIES, MOVE.

(e) Training emphasis will be placed on movement at combat speed.

(4) *Performance.* Instructor gives commands and men perform movements.

b. *Butt Stroke* (Fig. 5 and 6).

(1) *Objective and use.* The objective is to

disable or capture an opponent by delivering a forceful blow to his body with the rifle butt. The aim of the butt stroke may be the opponent's weapon as well as a vulnerable portion of his body. The butt stroke may be vertical, horizontal, or somewhere between the two planes.

(2) *Execution (instructor explains and demonstrates)*. STEP FORWARD WITH YOUR TRAILING FOOT; AT THE SAME TIME, USING YOUR LEFT HAND AS A PIVOT, SWING THE RIFLE IN AN ARC AND DRIVE THE RIFLE BUTT INTO YOUR OPPONENT. TO RECOVER, BRING YOUR TRAILING FOOT

(b) ATTACK POSITION, MOVE.

(c) At combat speed the command is BUTT STROKE TO THE (head, groin, kidney) SERIES, MOVE.

(d) Training emphasis will be placed on movement at combat speed.

(4) *Performance*. Instructor gives commands and men perform movements.

c. *Slash (Fig. 7)*.

(1) *Objective and use*. The objective is to disable or capture an opponent by cutting him with the blade of the bayonet.

(2) *Execution (the instructor explains and*

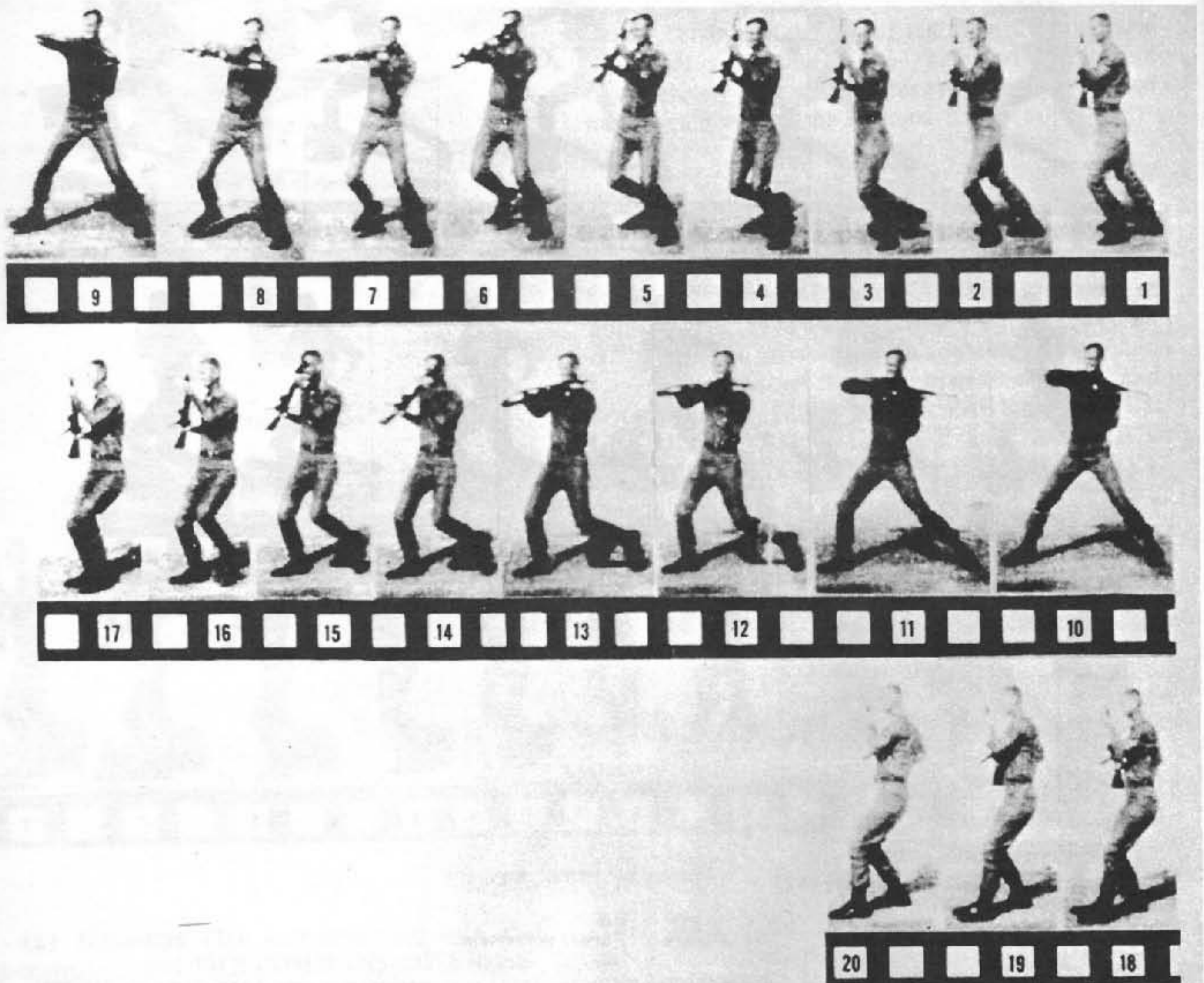

Figure 5. Butt stroke to the head.

FORWARD AND ASSUME THE ATTACK POSITION.

(3) *Commands*. The movement is taught by the numbers in two phases:

(a) BUTT STROKE TO THE (head, groin, kidney) AND HOLD, MOVE.

demonstrates). STEP FORWARD WITH YOUR LEAD FOOT; AT THE SAME TIME EXTEND YOUR LEFT ARM AND SWING THE KNIFE EDGE OF YOUR BAYONET FORWARD AND DOWN IN A SLASHING ARC. TO RECOVER, BRING YOUR TRAILING FOOT FORWARD AND ASSUME THE ATTACK POSITION.

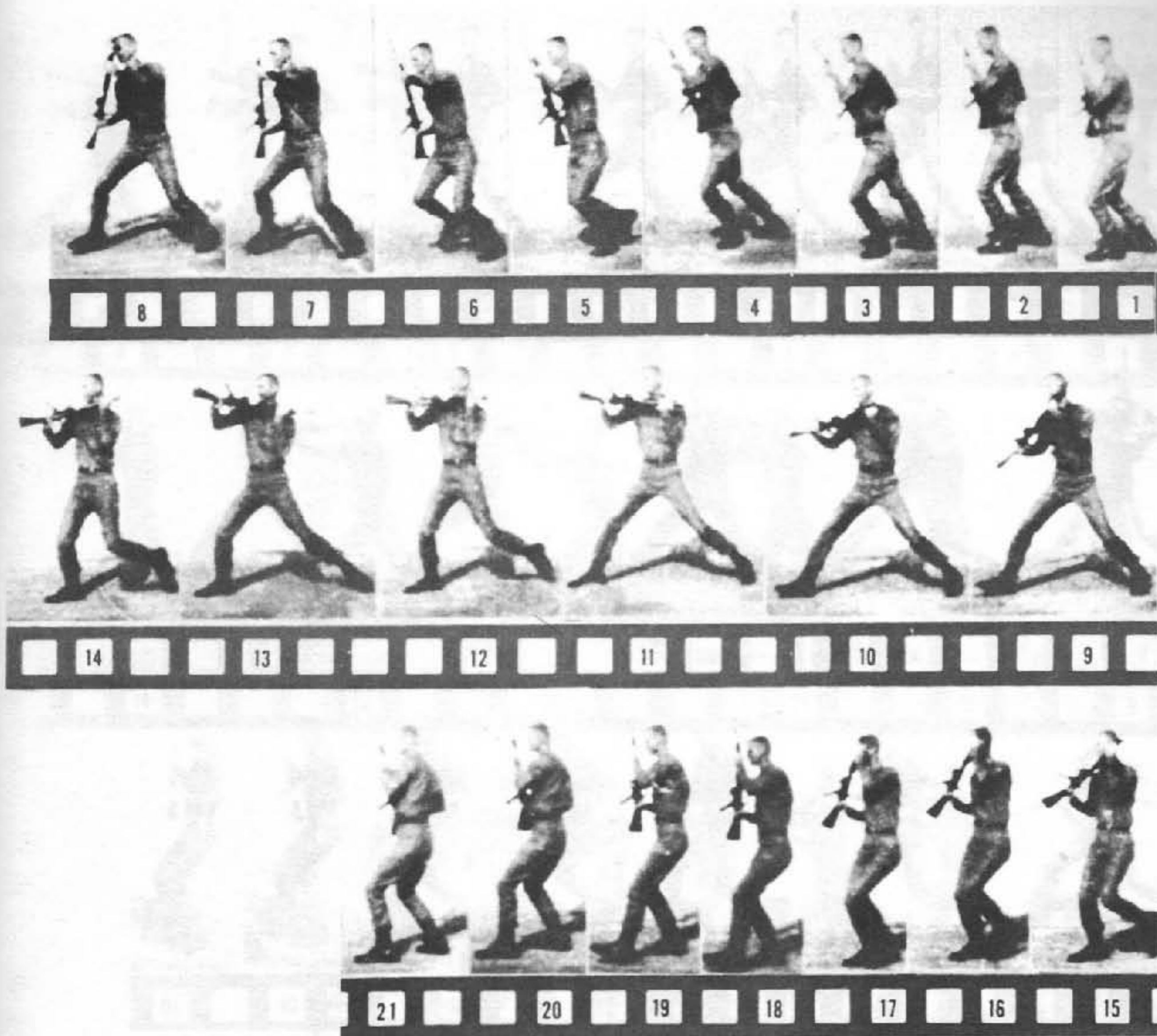

Figure 8. Butt stroke to the groin.

(3) *Commands.* The movement is taught by the numbers in two phases:

(a) SLASH AND HOLD, MOVE.

(b) ATTACK POSITION, MOVE.

(c) At combat speed the command is SLASH SERIES, MOVE.

(d) Training emphasis will be placed on movement at combat speed.

(4) *Performances.* Instructor gives commands and men perform movements.

d. *Smash (Fig. 8).*

(1) *Objective and use.* The objective is to disable or capture an opponent by smashing the rifle butt into a vulnerable portion of his body. The smash is frequently used as a followup to a butt stroke and is also effective in wooded areas or trenches when movement is restricted.

(2) *Execution (the instructor explains and demonstrates).* PUSH THE BUTT OF THE RIFLE UPWARD UNTIL HORIZONTAL AND

ABOVE THE LEFT SHOULDER, WITH THE BAYONET POINTING TO YOUR REAR, SLING UP. THE WEAPON IS APPROXIMATELY HORIZONTAL TO THE GROUND AT THIS TIME. STEP FORWARD WITH THE TRAILING FOOT, AS IN THE BUTT STROKE, AND FORCEFULLY EXTEND BOTH ARMS, SLAMMING THE RIFLE BUTT INTO THE OPPONENT. TO RECOVER BRING YOUR TRAILING FOOT FORWARD AND ASSUME THE ATTACK POSITION.

(3) *Commands.* The movement is taught by the numbers in two phases:

(a) SMASH AND HOLD, MOVE.

(b) ATTACK POSITION, MOVE.

(c) At combat speed the command is SMASH SERIES, MOVE.

(d) Training emphasis will be placed on movement at combat speed.

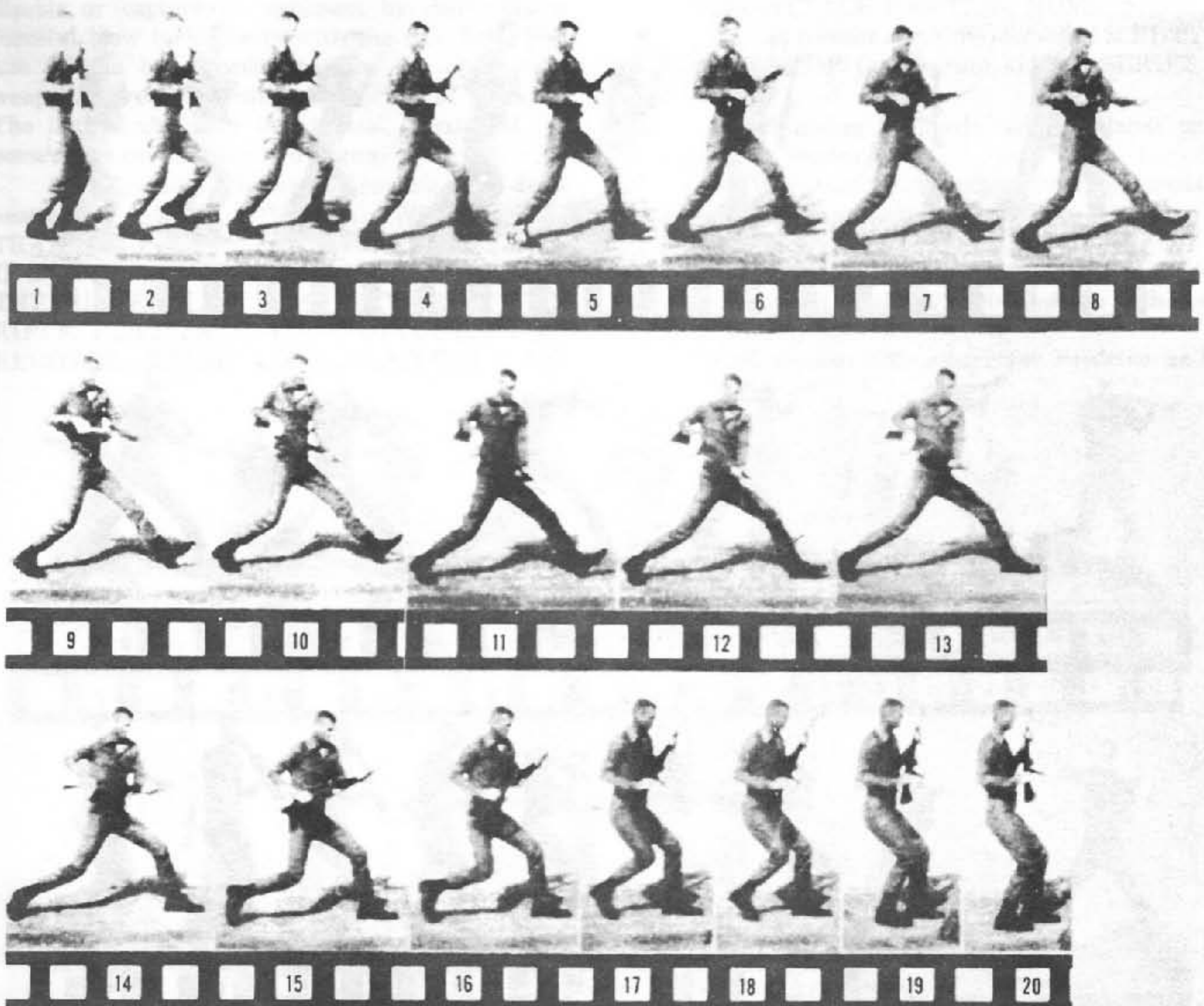

Figure 7. Slash movement.

(4) *Performance.* Instructor gives commands and men perform movements.

10. Defensive Movements

At times the soldier may lose the initiative and be forced to temporarily defend himself. He may also meet an opponent who does not present a vulnerable area to attack. Therefore, he must make an opening by initiating a parry or block movement, then followup with a vicious attack. The followup attack is immediate and violent.

a. Parry Movement.

(1) *Objective and use.* The objective is to counter a thrust, throw the opponent off balance, and hit a vulnerable area of his body. Timing, speed, and judgment are essential factors in these movements.

(2) *Execution (instructor explains and demonstrates).*

(a) *Parry right (fig. 9).* IF YOUR OP-

PONENT CARRIES HIS WEAPON ON HIS LEFT HIP (left handed), YOU WILL PARRY IT TO *YOUR RIGHT*. IN EXECUTION, STEP FORWARD WITH YOUR LEADING FOOT, STRIKE THE OPPONENT'S RIFLE, DEFLECTING IT TO YOUR RIGHT, AND FOLLOWUP WITH A THRUST, SLASH, OR BUTT STROKE.

(b) *Parry left (fig. 10).* IF YOUR OP- PONENT CARRIES HIS WEAPON ON HIS RIGHT HIP (right handed), YOU WILL PARRY IT TO *YOUR LEFT*. IN EXECUTION, STEP FORWARD WITH YOUR LEADING FOOT, STRIKE THE OPPONENT'S RIFLE, DEFLECTING IT TO YOUR LEFT, AND FOLLOWUP WITH A THRUST, SLASH, OR BUTT STROKE.

(c) *Recovery (fig. 11).* IMMEDIATELY RETURN TO THE ATTACK POSITION AFTER

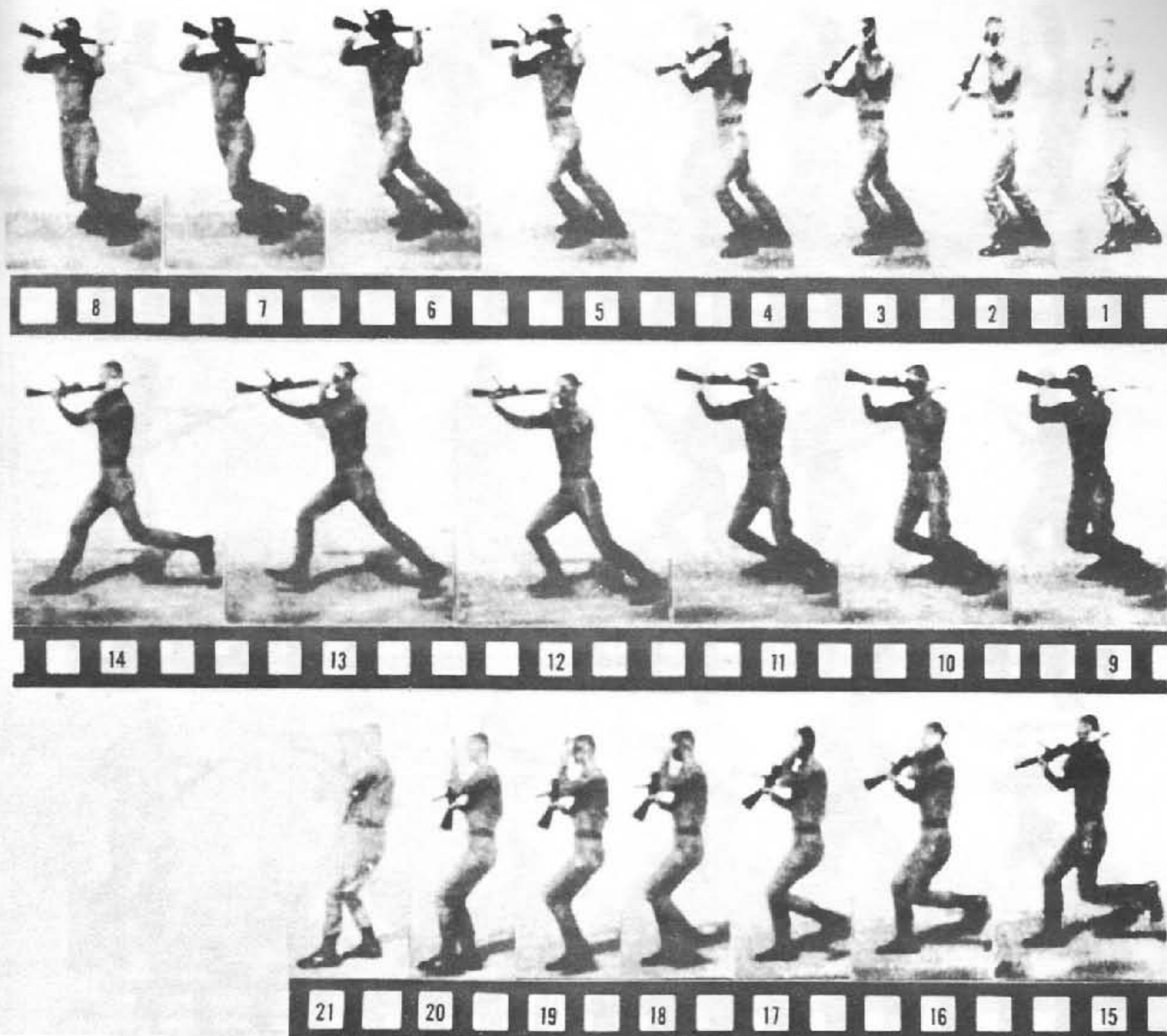

Figure 8. Smash movement.

COMPLETING THE PARRY AND FOLLOWUP ATTACK.

(3) *Commands.* The movement is taught by the numbers in three phases:

- (a) PARRY RIGHT (OR LEFT), MOVE.
- (b) THRUST MOVE.
- (c) ATTACK POSITION, MOVE.

(d) At combat speed the command is PARRY RIGHT (LEFT) or PARRY (RIGHT OR LEFT) WITH FOLLOWUP ATTACK.

(4) *Performance.* Instructor gives commands and men perform movements.

b. Block.

(1) *Objective and use.* When surprised by an opponent, the block is used to cut off the path of his attack by making weapon-to-weapon contact. A block must always be followed immediately with a vicious attack.

(2) *Execution (the instructor explains and demonstrates).* EXTEND YOUR ARMS USING THE CENTER PORTION OF YOUR RIFLE AS THE STRIKING AREA, CUT OFF THE OPPONENT'S ATTACK BY MAKING WEAPON-TO WEAPON CONTACT. STRIKE THE OPPONENT'S WEAPON WITH ENOUGH FORCE TO THROW HIM OFF BALANCE.

(a) *High block (fig. 12).* EXTEND YOUR ARMS UPWARD AND FORWARD AT A 45° ANGLE. THIS ACTION DEFLECTS AN OPPONENT'S SLASH MOVEMENT BY CAUSING HIS BAYONET, OR UPPER PART OF HIS RIFLE, TO STRIKE AGAINST THE CENTER PORTION OF YOUR RIFLE.

(b) *Low block (fig. 13).* EXTEND YOUR ARMS DOWNWARD AND FORWARD AT APPROXIMATELY 15° FROM YOUR BODY. THIS ACTION DEFLECTS AN OPPONENT'S BUTT



Figure 9. Parry right.

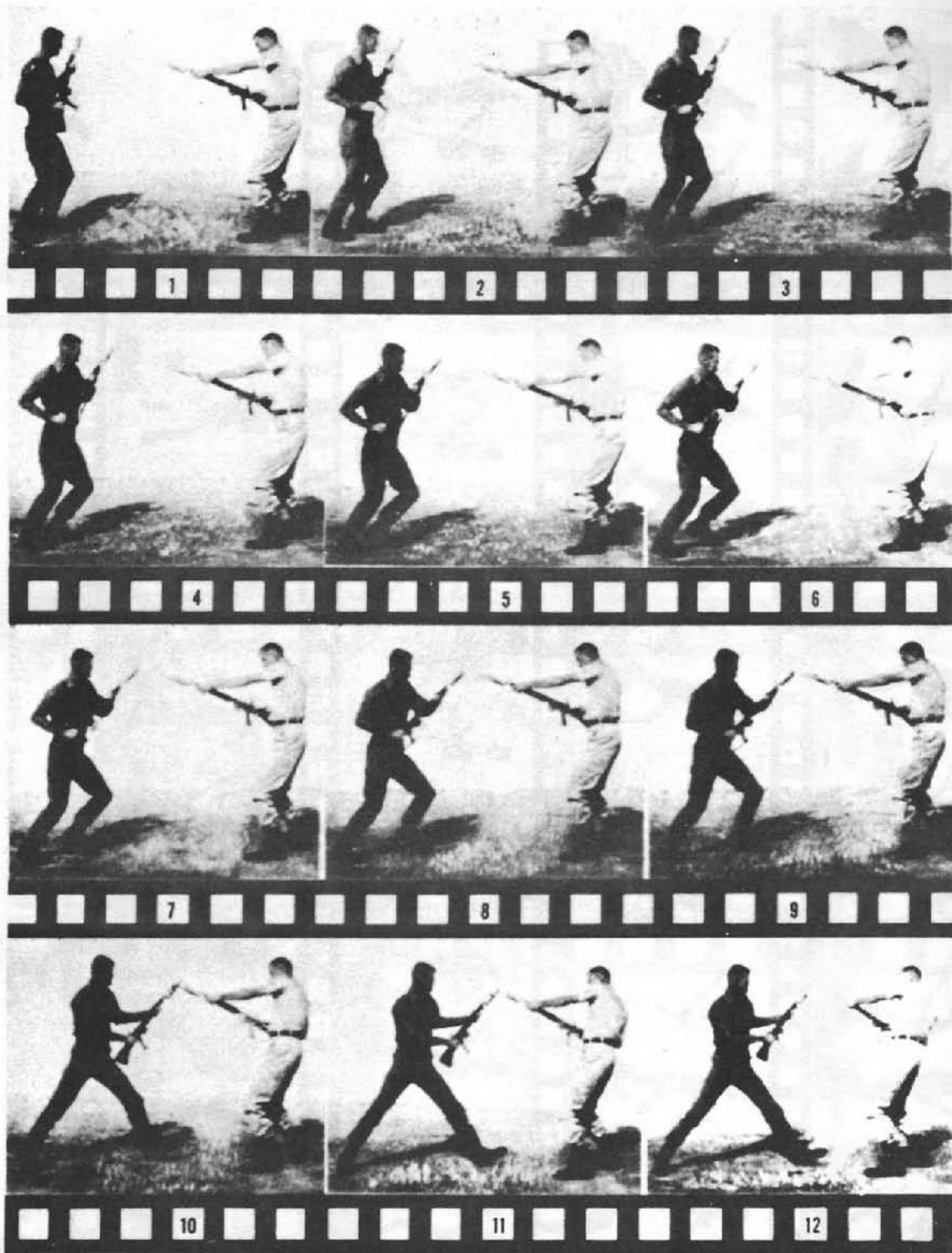

Figure 10. Parry left.

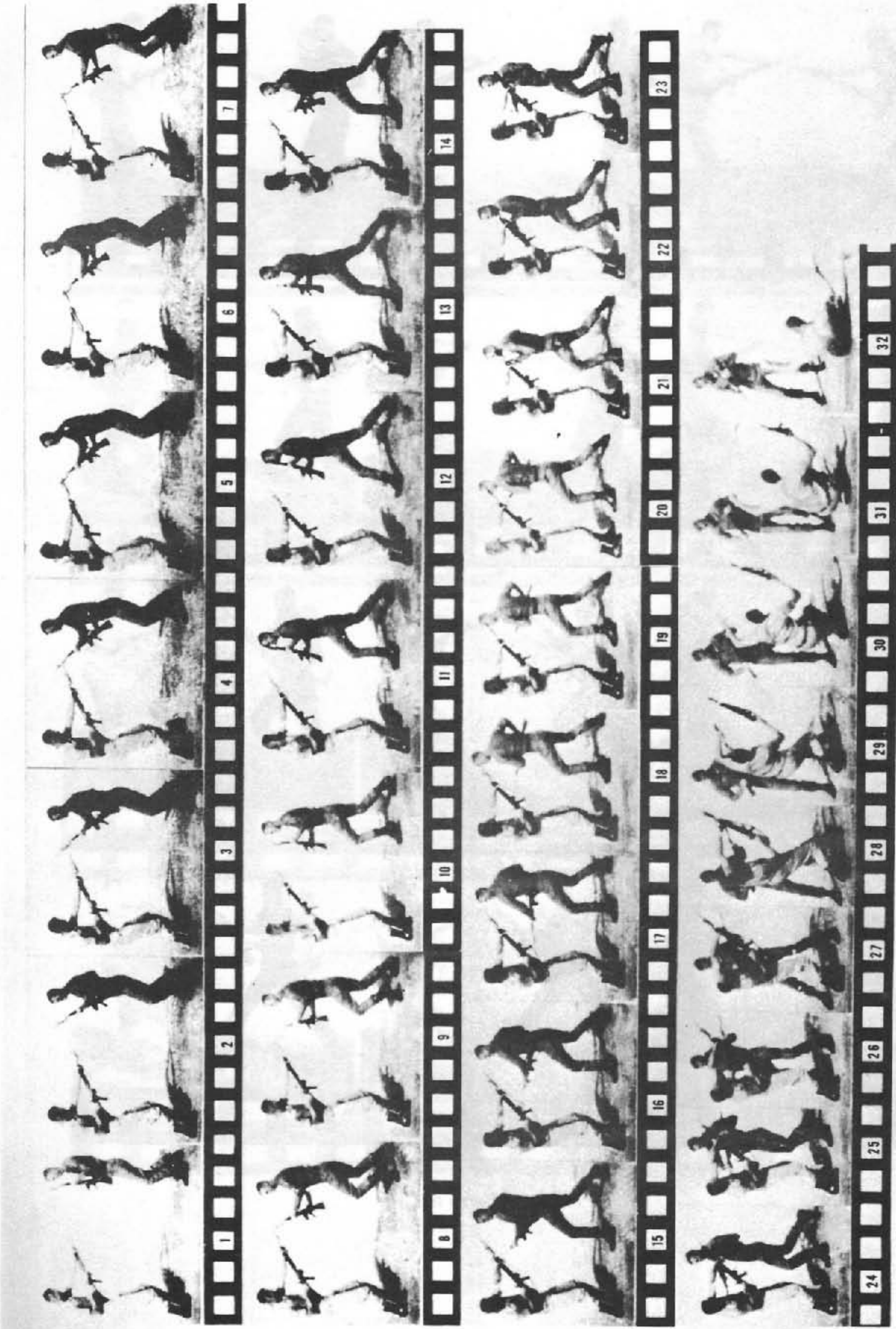

Figure 11. Parry left, slash, with followup butt stroke to the kidney region.

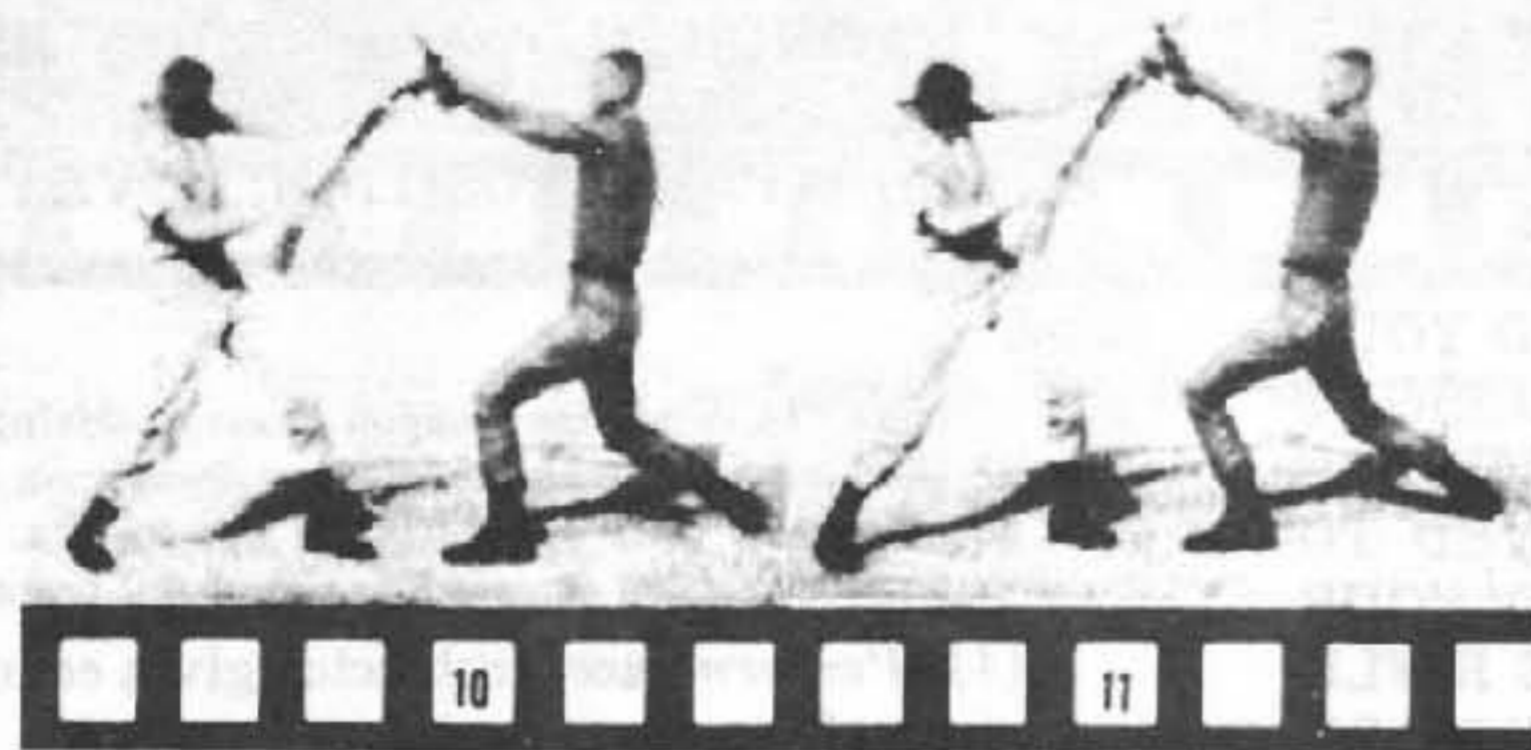

Figure 12. High block against slash.

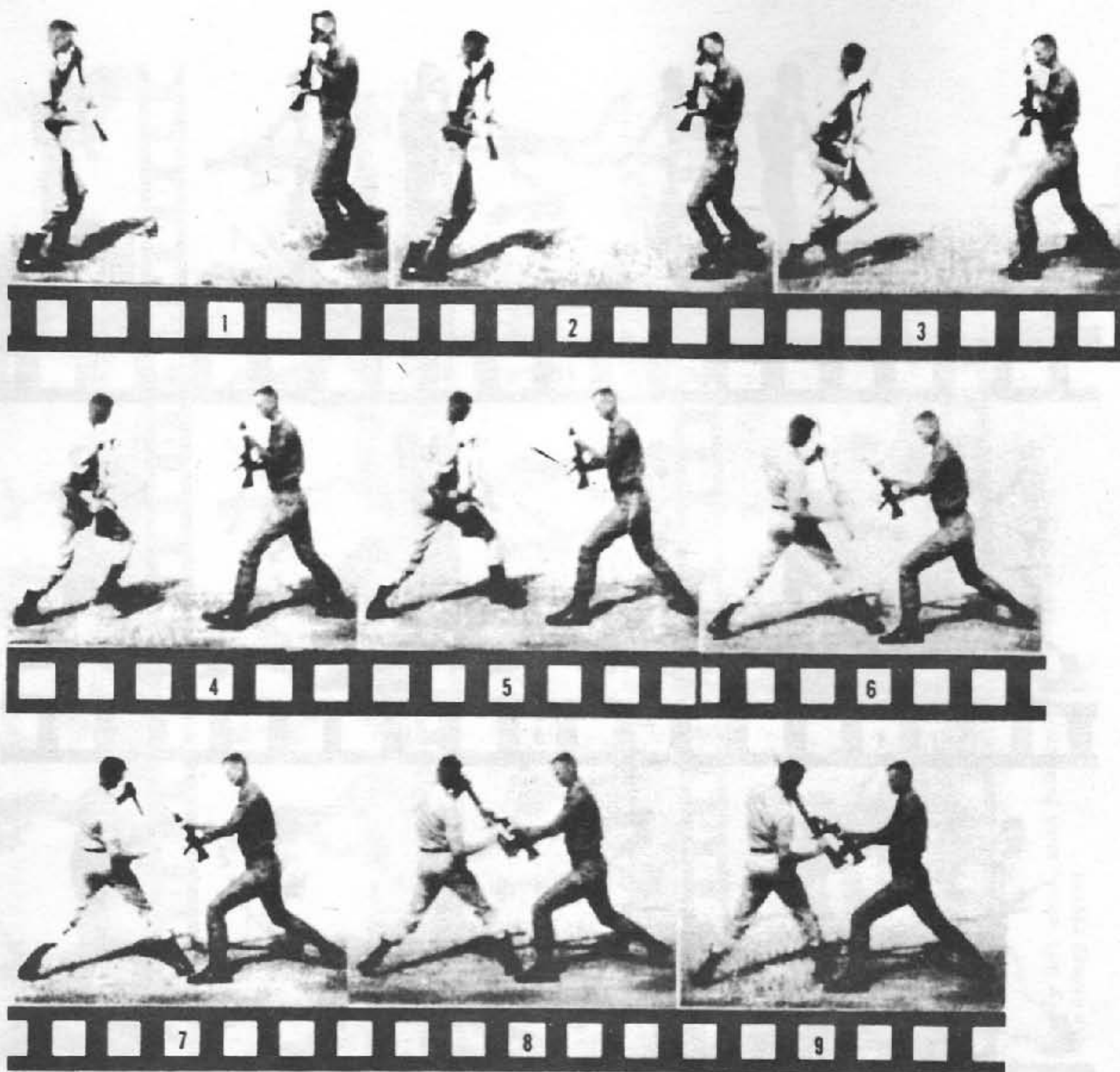

Figure 13. Low block against butt stroke to groin.

STROKE AIMED AT THE GROIN BY CAUSING THE LOWER PART OF HIS RIFLE STOCK TO STRIKE AGAINST THE CENTER PORTION OF YOUR RIFLE.

(c) *Side block (fig. 14)*. EXTEND YOUR ARMS WITH LEFT HAND HIGH AND RIGHT HAND LOW, THUS HOLDING THE RIFLE VERTICAL. THIS BLOCK IS DESIGNED TO STOP A BUTT STROKE AIMED AT YOUR UPPER BODY OR HEAD. PUSH THE RIFLE TO YOUR LEFT TO CAUSE THE BUTT OF THE OPPONENT'S RIFLE TO STRIKE THE CENTER PORTION OF YOUR RIFLE.

(d) *Recovery*. COUNTERATTACK WITH A THRUST, BUTT STROKE, SMASH, OR SLASH.

(3) *Commands*. Blocks are taught by the numbers in two phases:

(a) HIGH (LOW) or (SIDE) BLOCK, MOVE.

(b) ATTACK POSITION, MOVE.

(c) At combat speed the command is the same.

Note. To minimize weapon damage during training with the blocks and parries, weapon-to-weapon contact must be limited to half speed. These movements, at full or combat speed, can be stressed during pugil training.

(4) *Performance*. Instructor gives commands and men perform movements.

11. Modified Movements

Two attack movements have been modified to allow the rifle-bayonet fighter to slash or thrust an opponent without removing his hand from the pistol grip of the M16A1 rifle should the situation dictate.

a. *Modified Thrust*. The modified thrust is identical to the thrust as described in paragraph 9a with

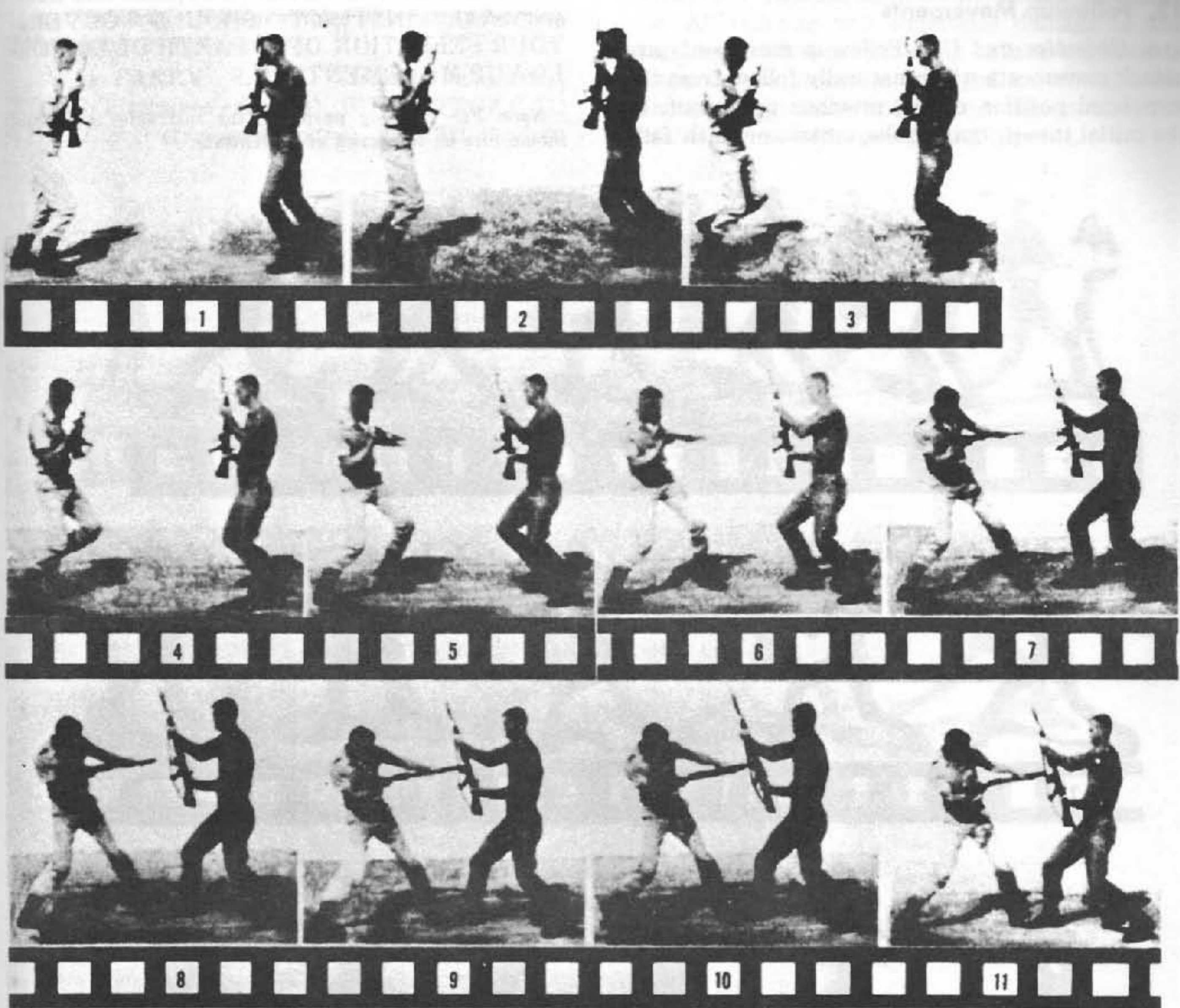

Figure 14. Side block against butt stroke.

the exception of the right hand grasping the pistol grip (fig. 15).

b. *Modified Slash.* The modified slash is identical to the slash as described in paragraph 9a with the exception of the right hand grasping the pistol grip (fig. 16).

12. Followup Movements

a. *Objective and Use.* Followup movements are attack movements which naturally follow from the completed position of the previous movement. If the initial thrust, butt stroke, smash, or slash fails

to make contact with the opponent's body, the soldier should instinctively followup with additional movements until he has disabled or captured the opponent. It is important to followup the initial attack with another aggressive action so the initiative is not lost.

b. *Execution (the Instructor Explains and Demonstrates).* INSTINCT SHOULD GOVERN YOUR SELECTION OF A PARTICULAR FOLLOWUP MOVEMENT.

Note. For training purposes, the instructor may and should mix up the series of movements.

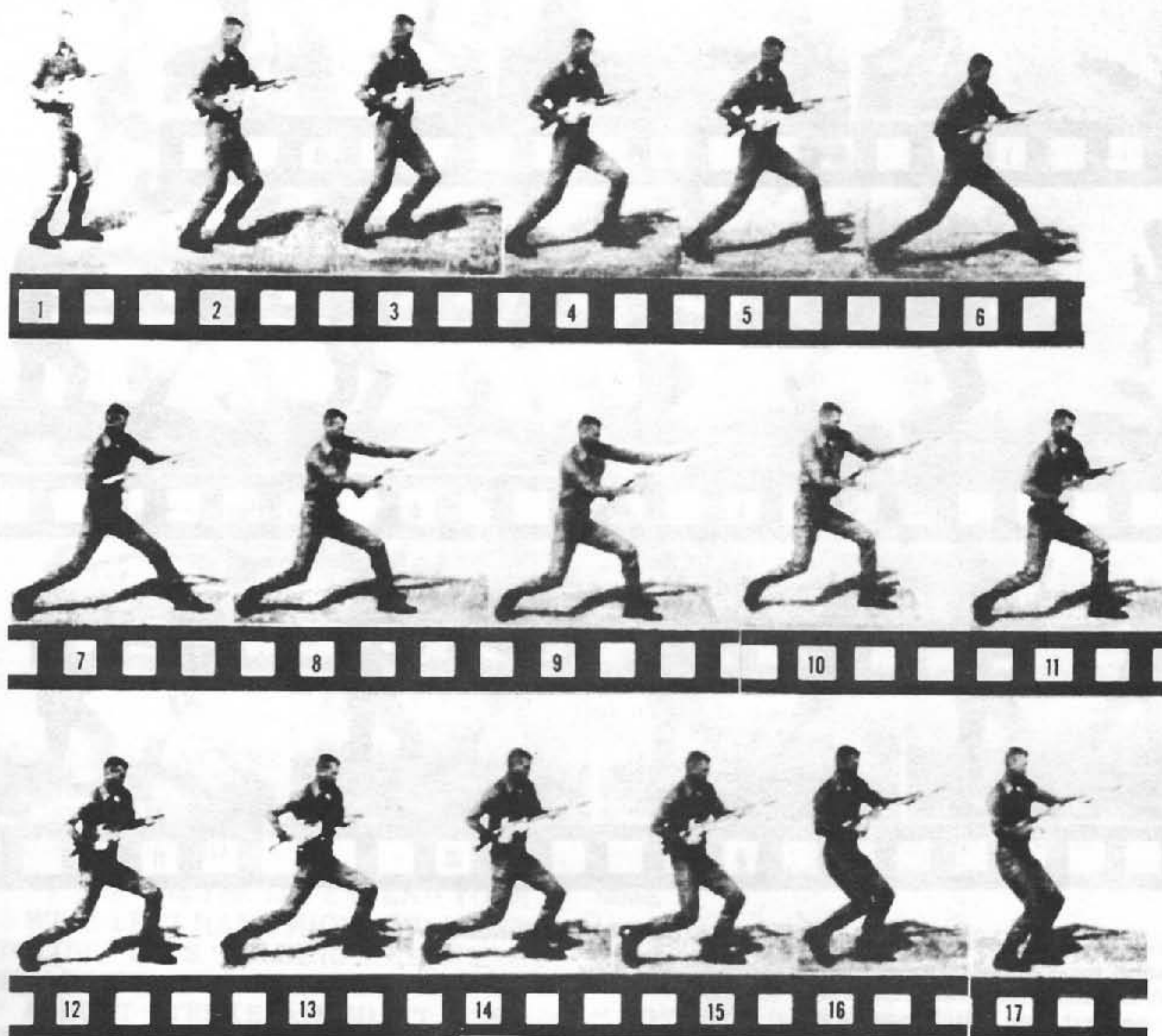

Figure 15. Modified thrust.

For example:

(1) PARRY LEFT, BUTT STROKE TO THE HEAD, SMASH, SLASH, ATTACK POSITION.

(2) PARRY LEFT, SLASH, BUTT STROKE TO THE KIDNEY, ATTACK POSITION.

(3) PARRY RIGHT, THRUST, BUTT STROKE TO THE GROIN, SLASH, ATTACK POSITION.

c. *Commands.* Two examples of commands using followup movements are:

(1) PARRY LEFT (trainee executes), THRUST (trainee executes), BUTT STROKE TO THE HEAD (trainee executes), SMASH (trainee

executes), SLASH (trainee executes), ATTACK POSITION (trainee assumes the attack position).

(2) THRUST (trainee executes), THRUST (trainee executes), BUTT STROKE TO THE GROIN (trainee executes), SLASH (trainee executes), ATTACK POSITION (trainee assumes the attack position).

d. All training will emphasize damage to the target and violent action using natural movements as opposed to precise stereotyped movements. Instinctive, aggressive action and balance are the keys to offense with the rifle and bayonet.

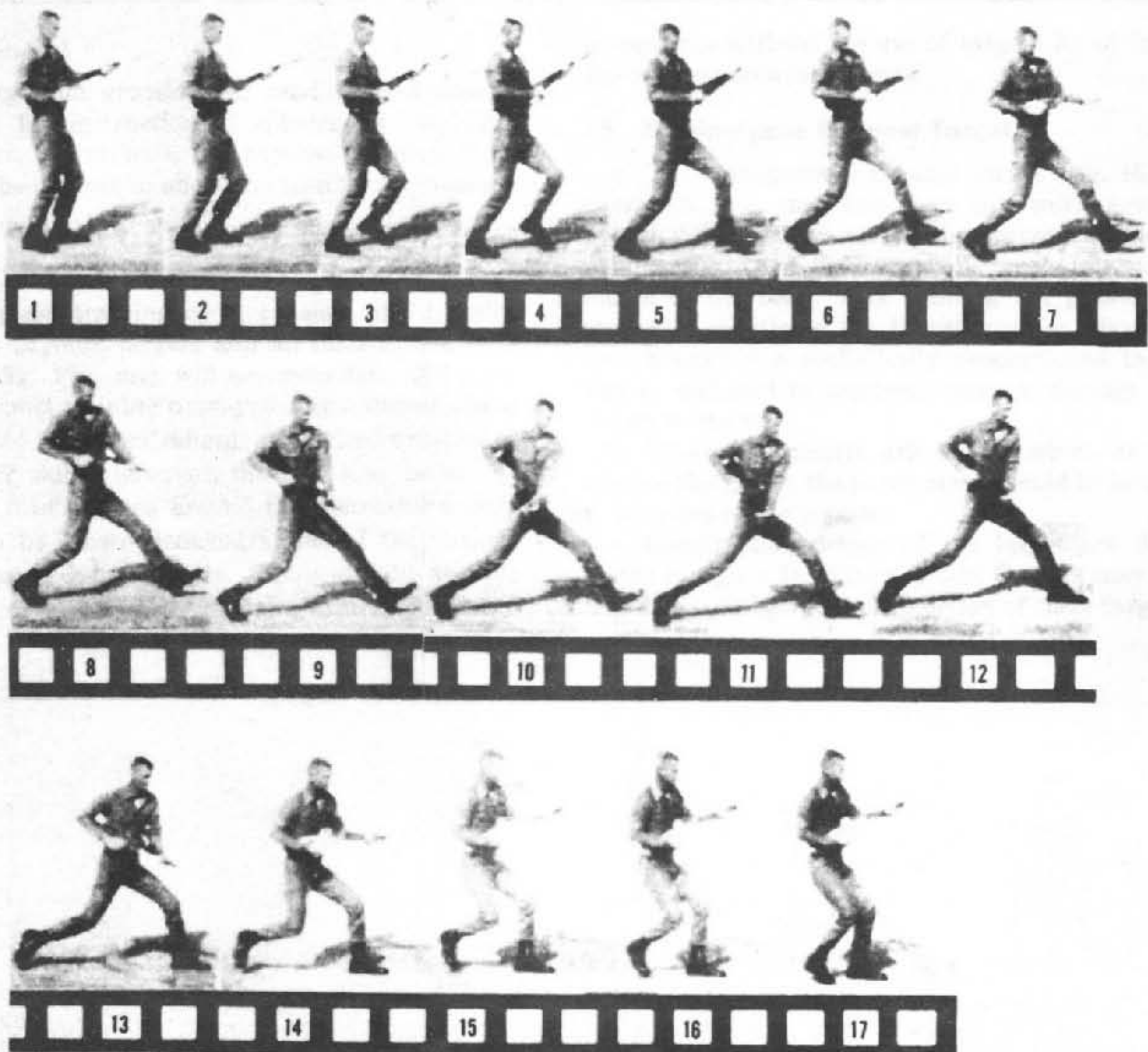

Figure 16. Modified slash.

CHAPTER 2

TRAINING FOR RIFLE-BAYONET FIGHTING

Section I. TRAINING FACILITIES

13. General

Any large, flat grassland or sand covered area is suitable for instruction of rifle-bayonet training. However, if available, the bayonet training court should be utilized to allow the men to make target contact.

14. Bayonet Training Court

The bayonet training court consists of 72 multipurpose bayonet targets and an instructor's platform (fig. 17), and will accommodate 288 men. The bayonet training court provides a training area organized for decentralized, supervised practice of the basic skills; however, the men may be moved quickly into an area around the instructor's platform to be shown demonstrations of the various positions and movements. There should also be ample room within the training court to execute

movements without the use of targets by utilizing the interval between targets.

15. Multipurpose Bayonet Target

a. The multipurpose bayonet target (fig. 18) is constructed so that two men can work against opposite sides of the target simultaneously except during practice of the butt stroke or smash movements to the head. This training aid provides a means of practicing the thrust, parries, slash, or smash against a realistically proportioned target and is designed to minimize weapon damage and injury to the men.

b. When movements are taught which do not involve the parry, the parry arms should be latched to the sides of the targets.

c. Construction details of the target are illustrated in figure 19. Training Aid Centers may obtain detailed plans for construction of these targets.

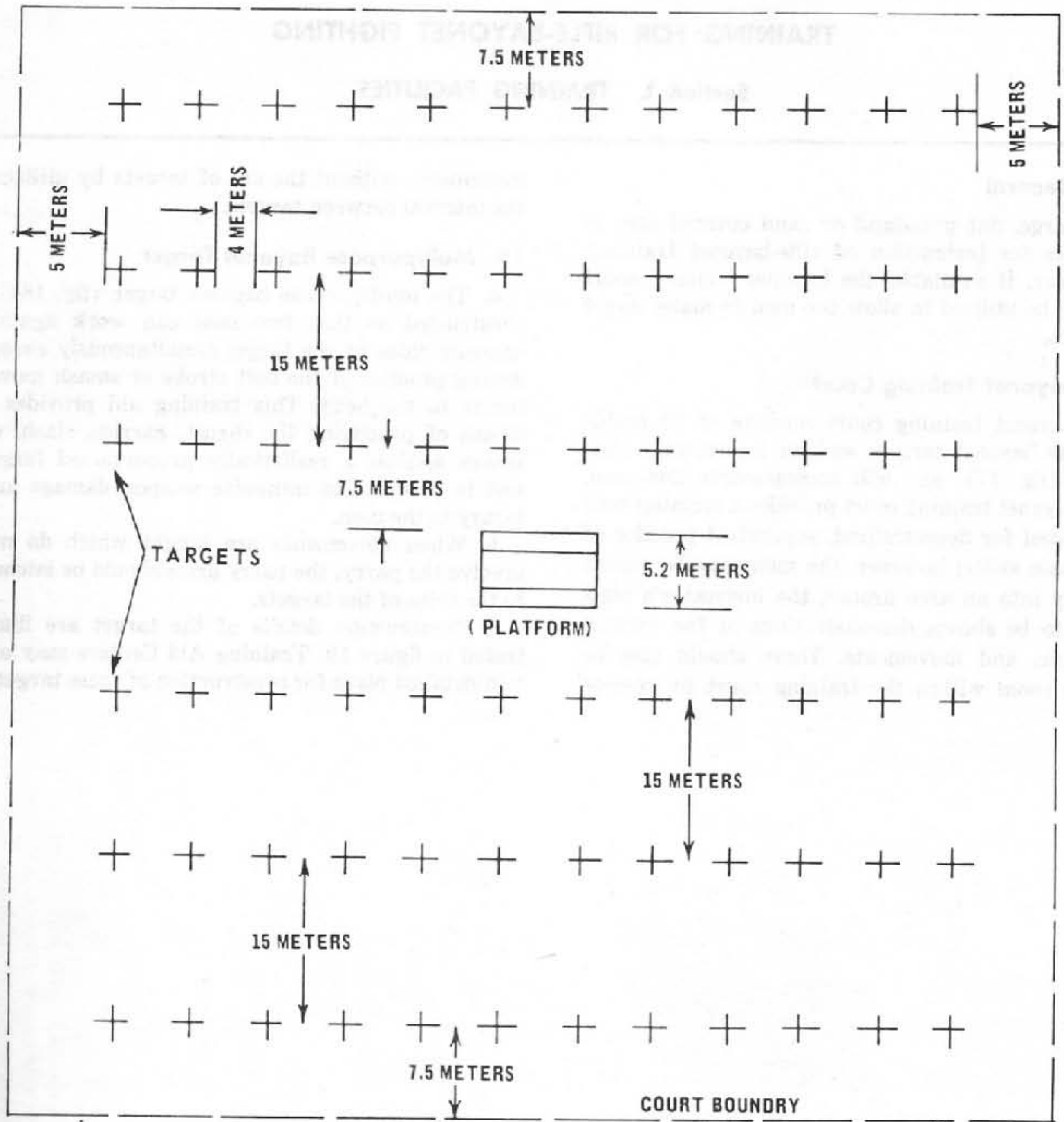

Figure 17. Bayonet court layout.

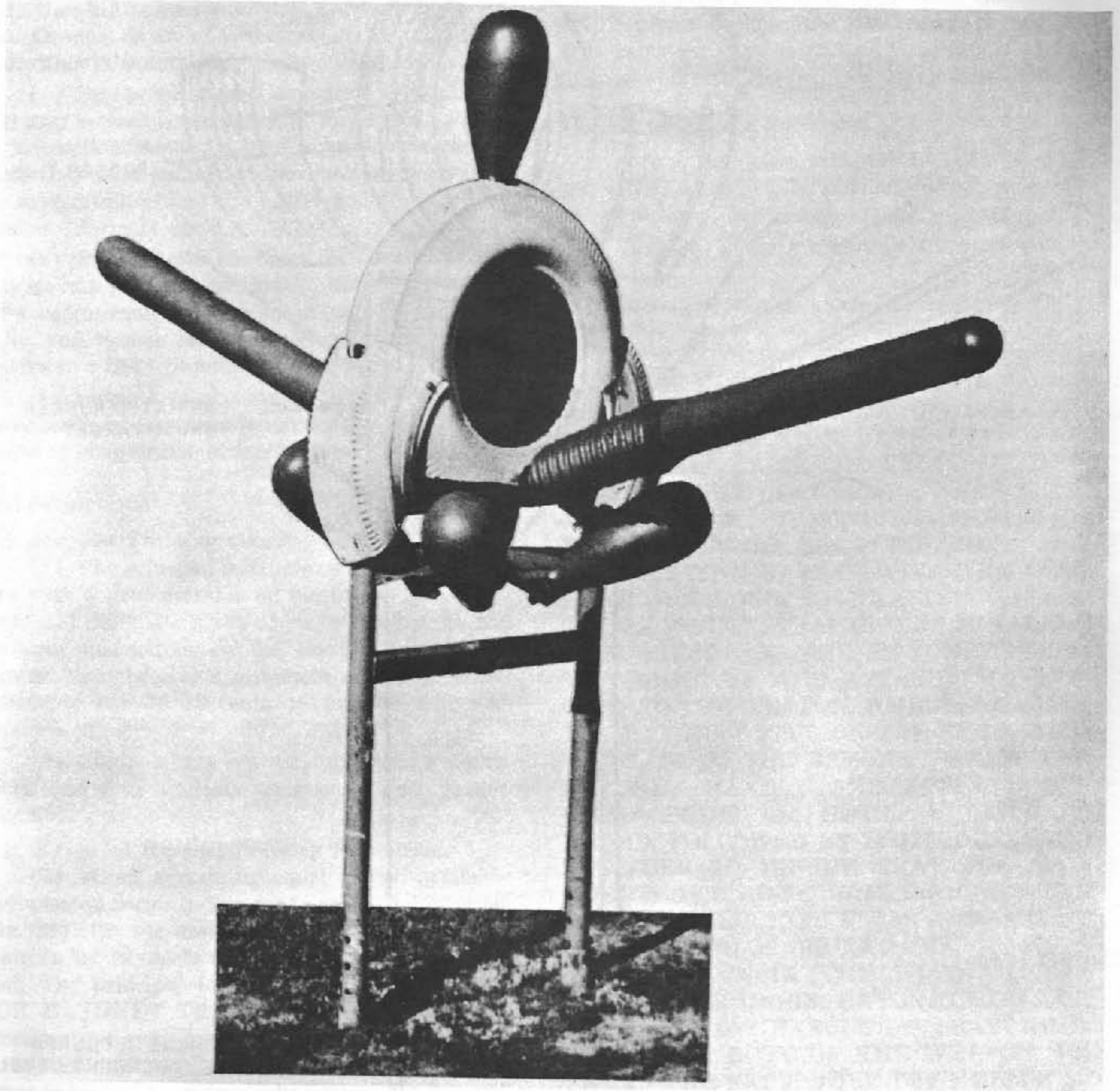
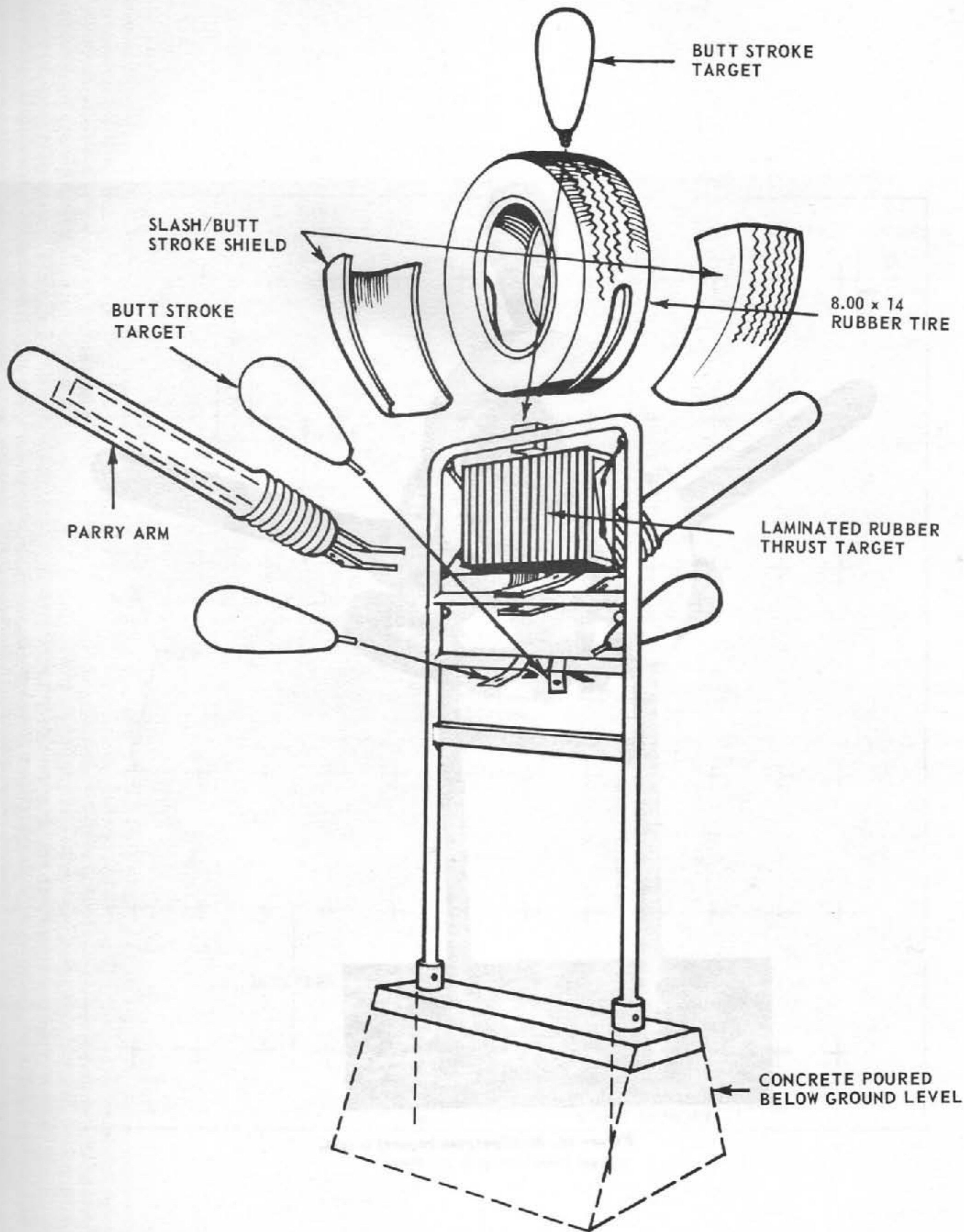

Figure 18. Multipurpose bayonet target.



Detailed blueprints for target construction may be obtained by Army Training Aids Centers and major units. Requests for quantities of blueprints copies should be consolidated prior to submitting requests. Requests will be sent to the Commanding General, 3d US Army, ATTN: DCS O&T, Fort McPherson, Ga. 30330.

Figure 19. Multipurpose bayonet target (schematic).

Section II. PREPARATION FOR TRAINING

16. Commands

Instruction in rifle-bayonet training is by command. Commands are used in maintaining control and to teach instant response. However, instructors should not expect instant and exact response during early training as men must first learn the skills.

a. Commands are of two types; by the numbers, and without the numbers.

(1) *By the numbers.* Commands by the numbers may be used if necessary, however this method of instruction should be used only when students show they lack sufficient coordination to execute the movements while working from slow motion to combat (normal) speed.

(2) *Without the numbers.* Whole commands indicate the men are to execute the entire movement as commanded. The speed may be slow initially, and as men learn the movements, speed increases to a fast or combat rate.

b. Appropriate commands for all positions and movements are incorporated in descriptions as contained in chapter one of this manual.

17. Formations

a. *Bayonet Training Court.*

(1) The principal instructor will take his position with a demonstrator on the instructor's platform and designate areas of responsibility for his assistant instructors on the court. It is recommended that there be a minimum of one assistant instructor per 15 students to provide adequate supervision.

(2) Students are moved onto the training court, and four students assigned to each target (fig. 20).

b. *Extended Bayonet Training Formation.*

(1) When a training court is not available each platoon forms in two ranks at normal interval (fig. 21). On the assistant instructor's command the men fix bayonets and assume the attack position. The principal instructor commands FORM FOR BAYONET TRAINING, MOVE, at which time the rear rank extends to the left taking up a three-step interval. Each front rank man double-times to his left front to secure a three-step interval and moves about 12 steps from the man who was behind him, executes a whirl, adjusts his position if needed and remains in the attack position. All men growl while moving.

Note. Instructors will insure that proper interval is constantly maintained to avoid injury.

(2) To assemble the group, the instructor commands ASSEMBLE, MOVE. At the command

MOVE, all students reform on the baseman (at doubletime) and assume the position of attention.

(3) To form for more detailed instruction, the instructor stands in front of the two ranks and directs the flanks to close towards the center. This produces a three-sided formation which enables the entire group to hear the conference or see the demonstration. At the end of the instruction the instructor directs, BACK TO YOUR PLACES.

18. Fix and Unfix Bayonets

a. *Safety.* For safety reasons commands for FIX and UNFIX BAYONETS should be given by the assistant instructor assigned to each group of men.

b. *Cadence.* These movements are not executed in cadence.

c. *Execution (the Instructor Explains and Demonstrates).*

(1) THE COMMAND IS FIX BAYONETS, AND IT IS EXECUTED ONLY FROM ORDER ARMS OR UNSLING ARMS. ON THE COMMAND OF EXECUTION, BAYONETS, GRASP THE BARREL, RAISE THE WEAPON SLIGHTLY, PLACE THE BUTT OF THE WEAPON BETWEEN THE FEET, MOVE THE MUZZLE OF THE WEAPON TO THE LEFT FRONT, AND REGRASP THE BARREL WITH THE LEFT HAND. WITH THE RIGHT HAND UNSNAP THE SECURING STRAP ON THE SCABBARD AND WITHDRAW THE BAYONET. TURN THE POINT UP AND ATTACH THE BAYONET TO THE WEAPON. WHILE ENGAGING THE BAYONET STUD ON THE RIFLE WITH THE BASE OF THE BAYONET, GRASP THE BAYONET HANDLE AND APPLY DOWNWARD PRESSURE UNTIL A CLICK IS HEARD, FOLLOWED BY LIMITED UPWARD PRESSURE TO INSURE THAT THE BAYONET IS SEATED SECURELY. RESNAP THE SCABBARD SECURING STRAP AND RESUME THE POSITION OF ORDER ARMS.

(2) TO UNFIX THE BAYONET THE COMMAND IS UNFIX, BAYONETS. ON THE COMMAND OF EXECUTION, BAYONETS, PLACE THE BUTT OF THE WEAPON BETWEEN THE FEET, MOVE THE MUZZLE TO THE LEFT, AND SECURE IT WITH THE LEFT HAND. WITH THE RIGHT HAND UNSNAP THE SCABBARD SECURING STRAP. NOW RELEASE THE BAYONET FROM THE BAYONET STUD WITH THE RIGHT HAND AND REMOVE THE BAYONET FROM THE MUZZLE. KEEPING YOUR EYES ON THE BAYONET POINT, RETURN IT TO THE SCABBARD, INSERTING IT WITH THE RING

FACING TO THE FRONT. RESNAP THE SECURING STRAP AND RESUME ORDER ARMS.

Note. For safety purposes, if the bayonet appears difficult to remove, stick the point into the ground, bend over, and depress the catch with the left hand while pulling upward on the weapon with the right hand.

19. Warmup Exercises

Warmup exercises at the beginning of rifle-bayonet training periods relax the men and help develop their muscle coordination. Five or ten minutes should be allotted for these exercises. An excellent warmup exercise is to practice the basic positions and the crossover movement prior to actual training in the various attack movements, such as the thrust.

20. Training Emphasis

a. The instructor should encourage the men to growl. Noise, however, is no substitute for enthusiasm or ability.

b. The men should be in fairly good physical condition before they begin bayonet training.

c. The instructor explains and demonstrates briefly and clearly. He and his assistants first demonstrate the movements in slow motion and explain so that each movement is clear. Then they demonstrate by the numbers so that each part of the movement can be understood. This is followed by a demonstration of the movement at combat speed.

d. The instructor stresses speed, balance, timing, and distance judgment. Since a tense soldier cannot fight effectively with his rifle and bayonet, the instructor also stresses muscle relaxation.

e. Each man must think and act for himself. Therefore, the instructor should avoid the harmful

practice of turning rifle and bayonet practice into a drill.

21. Care of Weapon

a. Prior to rifle-bayonet training the men must remove the maintenance equipment from the butt stock of the M14 and M16 rifles. (Recent production models of M16 have an equipment stowage compartment on the stock.) This will prevent injuries should the stowage compartment door of the butt plate open and the equipment come out accidentally.

b. Training personnel must remind men armed with the M16 rifle to maintain a firm grip on the small of the stock to prevent injury to the hand by the forward assist assembly.

c. Care must be exercised to teach proper assault and withdrawal of thrusts made at targets in which the bayonet penetrates the target. Improper assault or withdrawal may damage the M14 or M16A1 rifles. In running assault courses the distance from assault position to target must be gauged properly at the time of the thrust. If the man is too close to the target at the time of penetration, the forward momentum of the body causes the arms to push the butt of the rifle to the side. The force of such action could damage the barrel of the rifle. If withdrawal is improper (not straight to the rear), or if side-ward force is exerted on the rifle before withdrawal is complete, the weapon may be damaged. This may occur as the man begins his movement toward the next target, prior to a clean withdrawal from the current target. These faults are tendencies of beginners who, in their haste, fail to properly gauge distance or fail to perform a proper withdrawal.

Section III. METHOD OF TRAINING

22. Sequence of Training

Classes conducted on the training court generally should be organized in the following manner:

a. Explanation and demonstration of a skill with the men grouped around the instructor's platform.

b. The men practice in ranks between targets, not using the targets (fig. 20).

c. The men practice using the targets (fig. 21).

23. Control

a. Strict control of all activities must be maintained by the instructor on the platform. Adequate loudspeakers should be installed to carry commands clearly to all portions of the training court.

b. The men must be numbered in the following

manner (fig. 21): No. 1 and No. 2 men on one side of the target, No. 3 and No. 4 men on the other side of the target. When the men are practicing on the targets, all commands must be preceded by the designation of the man (or men) expected to execute the movement; for example: in practicing the thrust, the command could be ODD NUMBERS, THRUST, MOVE. Or, in the case of the movement using the butt stroke to the head: NUMBER THREE, PARRY LEFT, BUTT STROKE TO THE HEAD, MOVE. Throughout a class, periodic checks should be made by the instructor to insure that the men remember their assigned numbers. The men respond to only those commands which apply to their number.

a. To insure that close attention is paid to the

instructor, conversations between the men should not be permitted unless the coach and pupil method of instruction is being used.

24. Supervision

Adequate supervision during practice is obtained by providing one assistant instructor per 15 men. Assistant instructors should correct errors and be alert for safety hazards. Assistant instructors should also watch for malfunctioning targets and either immediately repair the targets or shift the men to open targets.

25. Safety

a. The safety of the men should be a constant concern of the instructor and his assistants. The best safety aids are constant control and supervision. In addition, the men should be briefed at the beginning of each class on the requirements for safety during rifle-bayonet training. Bayonets must be fixed and unfixed only on command.

b. Rifles should be grounded near the targets with the operating rod handles facing upward when the men are ordered to move to the instructor's platform for explanations or demonstrations.

c. An even, level surface that does not become slippery when wet should be provided for the training court.

d. Left-handed men should be positioned so that they are opposite another left-handed individual

when working against the targets. This type of arrangement will prevent possible injuries when a series of movements are executed.

e. When using the M16A1 rifle against a target, the force of contact during the thrust movement may drive the hand, gripping the small of the stock, into the forward assist assembly (on the right side of the weapon near the stock). To prevent injury to the hand, a firm grip must be maintained on the small of the stock; gloves should be worn as part of the training uniform when weather dictates.

26. Continued Training

a. To maintain proficiency in rifle-bayonet fighting, unit commanders must continue training. Such training should consist of 30 minutes of practice 2 days per week. These periods will deal with pugil training and other training procedures of a varied and vigorous nature.

b. To retrain the correct procedures and coordination, practice the movements first by the numbers and then in slow motion. Increase the pace in order to develop speed, accuracy, and aggressiveness.

c. Throughout bayonet training, the men are trained to detect and strike instantly at any opening. Training develops coordination between the eyes and muscles thus producing mental and physical alertness.

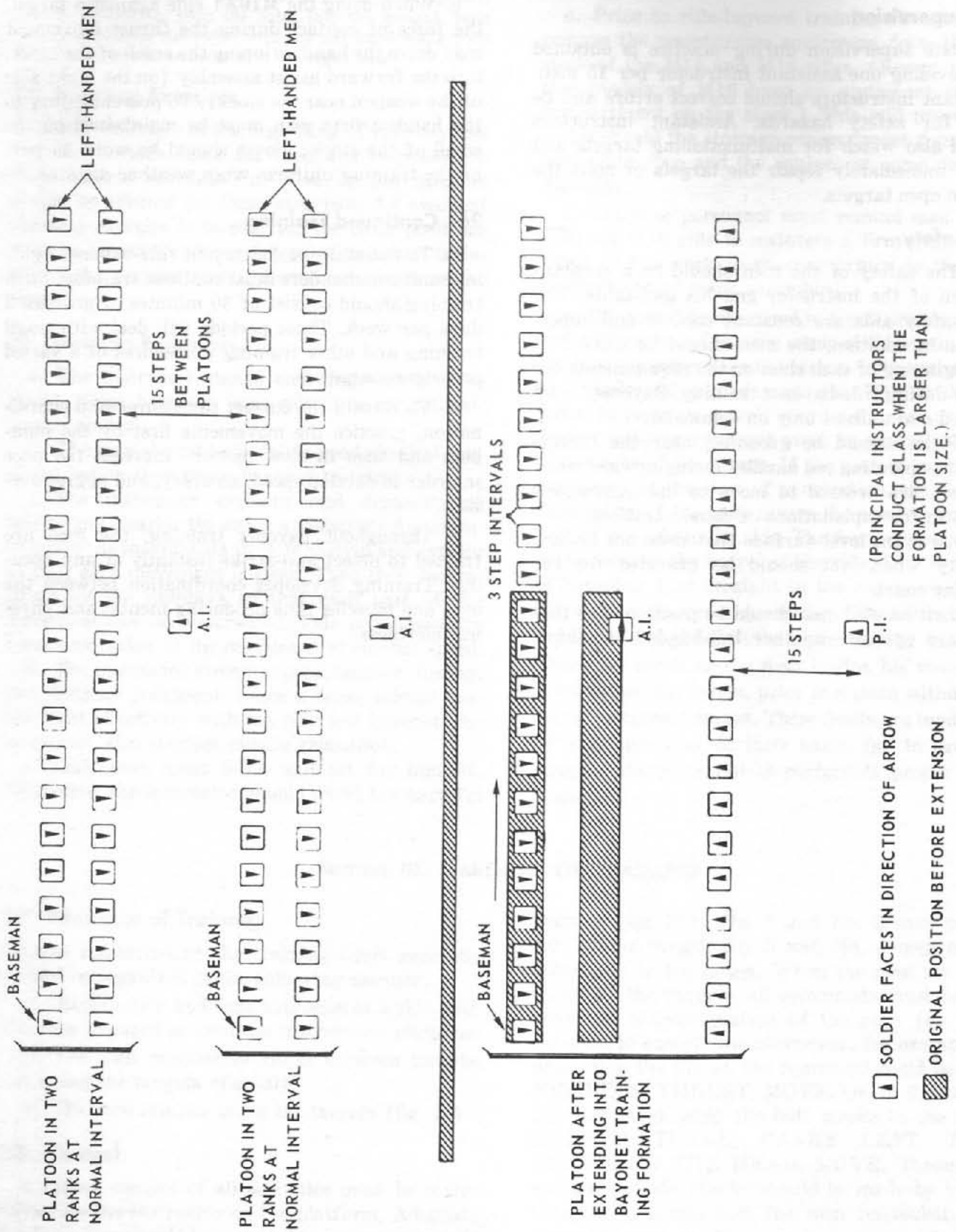
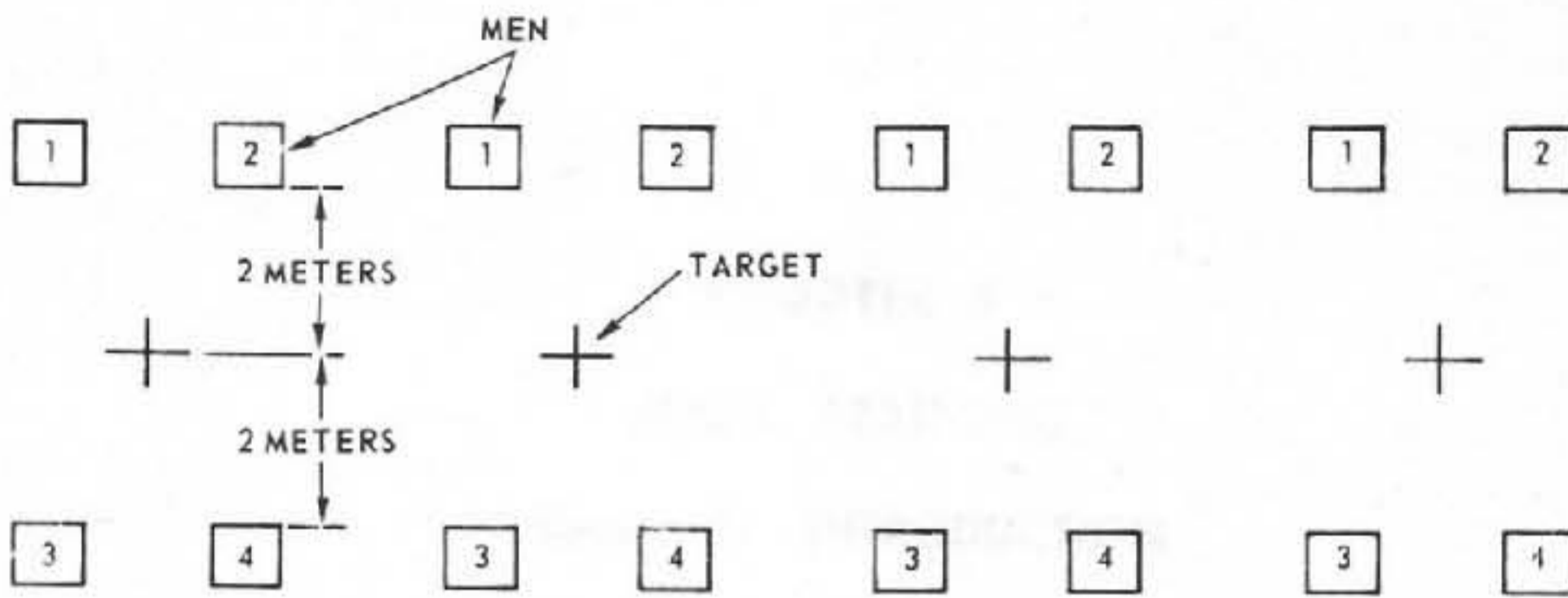
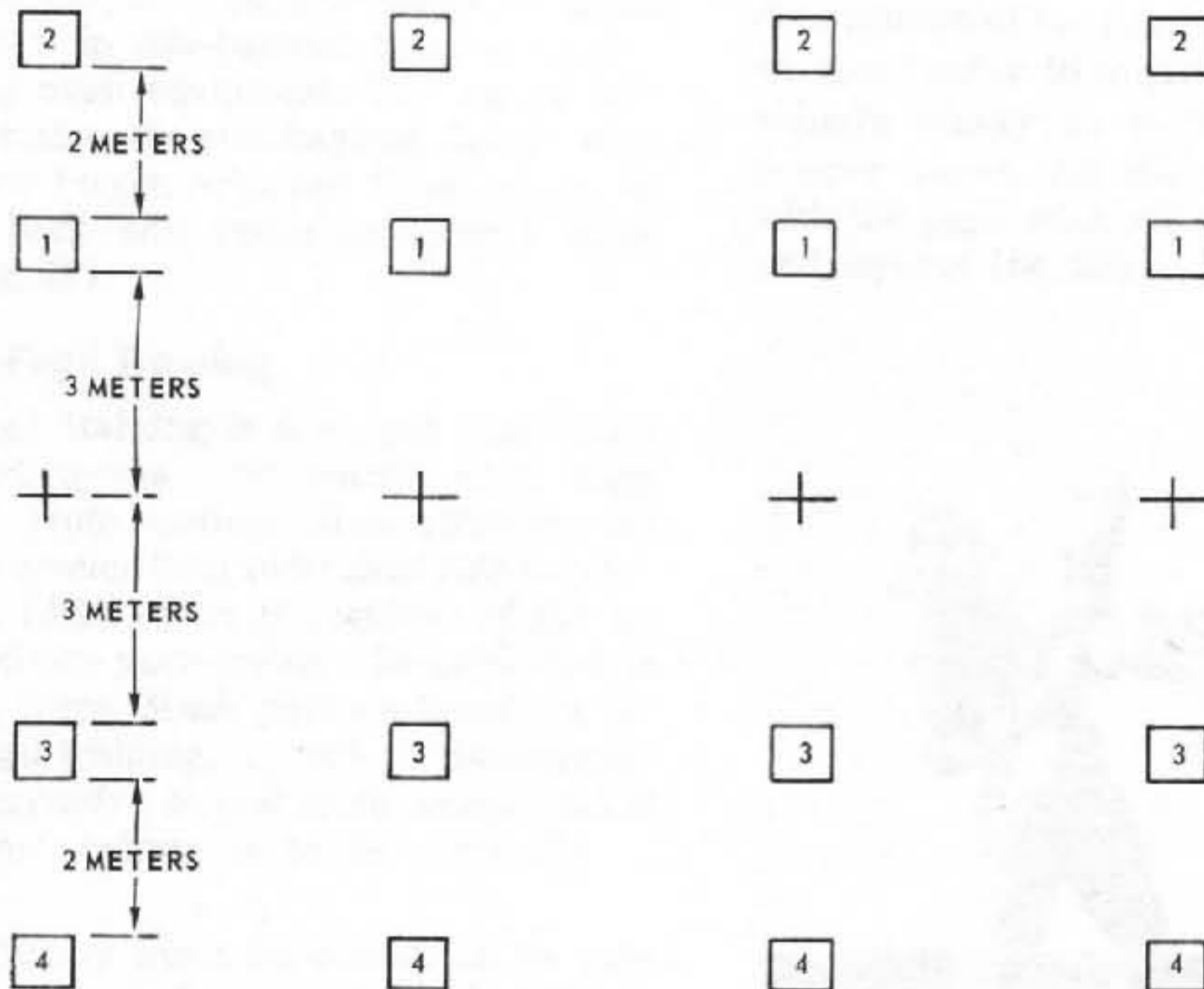

Figure 20. Extended bayonet training formation.



① FORMATION WHEN PRACTICING WITHOUT TARGETS



② FORMATION WHEN PRACTICING WITH TARGETS

2 — POSITION OF STUDENT WITH ASSIGNED NUMBER

+

 — MULTI-PURPOSE BAYONET TARGET

Figure 21. Formation when practicing with targets.

This Page Intentionally Left Blank

CHAPTER 3

PUGIL TRAINING

Section I. INTRODUCTION

27. General

Pugil training is a means of teaching the soldier to use the rifle-bayonet with confidence and aggressiveness. After the soldier has become proficient in the basic positions and movements with the rifle-bayonet, he should then be introduced to pugil training. Realism in rifle-bayonet training is provided by using pugil equipment. The use of this equipment furnishes the rifle-bayonet fighter with an opponent, or target, who can think, move, be evasive, fight back, and (most important) make corrections (fig. 22).

28. Value of Pugil Training

a. Since pugil training is a rugged contact activity, the participants must remain alert. They act and react from instinct, thus affording an opportunity to develop their individual rifle-bayonet fighting skills. Little effort is required of the instructor to motivate participants; the pugil stick is the motivating force. Much physical benefit is derived from pugil training, as well as the development of the aggressive mental spirit so essential if the rifle-bayonet fighter is to be successful in combat.

b. Several factors must be considered to gain maximum effectiveness from pugil training. These factors include training, control, supervision, safety, and protective equipment (chap. 4).

29. Training

a. The rifle-bayonet fighter should be taught the basic positions and movements, as well as the series

of followup movements, with the rifle-bayonet before beginning pugil training.

b. The pugil stick (chap. 4), for maximum training benefit, should approximate the length and the weight of the M16 rifle with bayonet attached. Substitution of the pugil stick for the rifle provides an opportunity to improve skill and test the individual's ability to perform against a realistic, evasive target. All the positions and movements with the pugil stick are the same as with the rifle and bayonet (fig. 23).



Figure 22. Man-to-man contact is possible with pugil equipment.



Figure 23. Positions and movements with the pugil stick are the same as with the rifle.

Section II. CONDUCT OF PUGIL TRAINING

30. Warmup Round

In the early stages of pugil training, maximum benefit is gained by working with platoon-size groups (or smaller) in a circular formation. Two men engage in a pugil bout in the center of the circle. Critiques are conducted so that all may learn from the observed mistakes. All members of the group should participate in as many bouts as necessary to gain proficiency prior to going on to more advanced training. The platoon forms a circle at double-arm interval. Two contestants and one instructor are in the center. The contestants assume the attack position 12 steps from each other. In the first round they are allowed to mix-it-up. The purpose is to prove to contestants that the equipment will provide ample protection from a hard blow. Immediately after the warmup round, the contestants will engage in graded bouts.

31. Graded Bouts

a. During the graded bouts (fig. 24) the op-



Figure 24. A pugil bout.

ponents face each other 12 steps apart. The bout consists of three rounds. The instructor should be in a position where he can best control the bout. To score a point or win a round, a contestant must score a solid blow with either end of the pugil stick to a vulnerable point, e.g., the head, throat, chest, stomach, or groin regions.

b. To start a bout or a round the instructor blows the whistle and the contestants move toward each other in the attack. A point is awarded to the man striking the first disabling blow. A disabling blow is determined to be any blow that is delivered to the vulnerable parts of the opponent's body.

When such a blow is struck a whistle is used to stop the round. At the end of a round contestants move back to their respective lines, assume the attack position, and wait for the signal to start the next round. The contestant who wins two of the three rounds wins the bout.

c. A contestant should be encouraged to move in aggressively and attack violently, using any of the attack movements learned during rifle-bayonet training. If he misses, or his opponent sidesteps, he should immediately followup until he has landed a blow to a vulnerable spot.

d. Motivation is no problem in pugil training. The man who hesitates to strike his opponent realizes that defeat can be quick and will try aggressively to overcome his opponent in the shortest possible time.

e. Competition in pugil training is keen. Due to the nature of the two-man bouts, a squad, platoon,

and finally a company champion may be selected. Competition should be encouraged by instructors whenever possible throughout the pugil training program.

32. Control, Supervision, and Safety

a. Instructors supervising pugil training must understand its values and limitations. The instructor maintains control of the bout at all times; his best method of control is by blowing a whistle to start and stop action. He is alert to prevent wild swinging of the pugil sticks, and insures that the contestants keep their eyes on each other. For safe-

ty reasons men should be paired who are approximately the same height and weight.

b. Contestants use only the positions and movements that they have been taught in rifle-bayonet training. The stick must be held in the same manner, and blows delivered, as with the rifle-bayonet.

c. One instructor is necessary for each bout. Additional assistance is required to supervise the fitting and exchange of equipment. During the fitting process instructors insure that equipment is properly fitted. Instructors constantly observe to determine any loose or broken equipment. Immediately upon detection of insecure equipment, the instructor stops the bout to prevent possible injuries. After deficiencies have been corrected, the round is resumed.

d. The instructor insists that the contestants growl during the bouts; this adds to their aggressiveness and will tend to reduce tension.

e. Individuals who have had prior medical problems such as hernias, frequent headaches, previous brain concussions, recent tooth extractions, or current lacerations containing stitches must be excluded from pugil training for safety reasons. Therefore, before conducting pugil training it is necessary to screen individual medical records to determine if anyone should be eliminated from participation. Finally always be alert for the unexpected, and if in doubt stop the bout immediately to prevent injury.

Section III. PUGIL COURSES

33. Human Thrusting Target Course

After several two-man bouts, the rifle-bayonet fighter is ready for the human thrusting target course. Eight to ten men are lined up in file 12 steps apart. Each man is designed by the instructor to act as a specific type target. The rifle-bayonet fighter, also in pugil gear, walks to each human target, moving with the pugil stick at the attack position. As the rifle-bayonet fighter approaches an opponent, the opponent shouts the movement that the rifle-bayonet fighter is to execute e.g., THRUST, SLASH, BUTT STROKE. After executing the movement the rifle-bayonet fighter pauses long enough for the instructor to make corrections, then he moves on to the next "target." The number of "walk throughs" is dependent on each man's ability to execute the movements correctly. Next,

he runs through the course at full speed, growling and executing the called movements with maximum force against his live opponents. Duties are rotated so that all men act as fighters and as human targets.

34. Human Thrusting Assault Course

A qualification-type course can be conducted to measure the proficiency of each man. This course should approximate an obstacle course in length, obstacles, and terrain. In laying out the course take advantage of natural obstacles such as streams, ditches, hills, and thick woods. Soldiers clad in pugil equipment can be placed among the obstacles to act as human targets. The remaining members of the unit, clad in pugil equipment, will negotiate all obstacles and human targets using instinctive rifle-bayonet fighting movements.

CHAPTER 4

PUGIL EQUIPMENT

Section I. INTRODUCTION

35. General

Protective equipment should allow the soldier to participate without either incurring or fearing injury. Being able to participate without the fear of injury will help the soldier to develop an individual style of fighting and improve his ability to fight with the rifle and bayonet. The areas which must be protected include the head and face, groin, and hands. The equipment described below is designed to prevent injuries.

36. Securing Pugil Equipment

The pugil sticks and groin aprons are constructed locally by training aids personnel. The helmet with

face mask attached, gloves, and protective groin cup are commercial items of nonstock type (fig. 25). Nonstandard stock numbers are used locally to identify these commercial items and they are obtained through local purchase. To secure proper equipment which meets standards of protection and safety, the supplier or contractor must be aware of the specifications as contained in paragraphs 37, 38, and 39. It should be noted that the mask is attached to the helmet in such manner that the mask will move somewhat when struck. This feature dispenses some of the shock that would be transmitted to the head and neck, should the mask be fastened tightly to the helmet.

Section II. PROTECTIVE EQUIPMENT AND STICK

37. Headgear

This includes a football helmet with a stainless steel face mask (fig. 26).

a. Football Helmet. When purchasing these helmets, due consideration should be given to the variation in the head size of individuals. For each 100 helmets purchased it is recommended that 10 percent be $6\frac{1}{2}$ to $6\frac{3}{4}$ in size, 80 percent be $6\frac{7}{8}$ to $7\frac{1}{8}$ in size, and 10 percent be $7\frac{1}{4}$ to $7\frac{1}{2}$ in size. Helmets that are too large for an individual can be adjusted to fit by adding foam rubber to the inside of the helmet. A chinstrap made of vinyl plastic and foam rubber is used to secure the helmet to the head.

b. Protective Face Mask Specifications.

(1) The protective face mask is made of $\frac{1}{4}$ -inch round stainless steel rods that are welded together by electric arc welds at all joining and intersecting points. The mask shall consist of a rear frame and a bottom frame to which three vertical and two horizontal rods are attached (fig. 27).

(2) The face mask is constructed according to directions (fig. 27). A vertical rod is attached on each side of the center rod, $2\frac{1}{4}$ inches to the side of the center rod.

(3) Two horizontal rods are used to reinforce the vertical rods. The upper of these rods is attached to the rear frame, at each side where the rear frame bends, and is attached on the under side of the vertical bars. The lower horizontal bar extends from one vertical side bar to the other passing under the center vertical bar. This bar is one inch above the base established by the bottom frame.

(4) The forward curve of the mask (fig. 27) is formed by:

(a) The contour of the rear frame as it curves downward toward the wearer's ears. This curve is formed on a radius of $3\frac{3}{4}$ inches measured from a point $2\frac{1}{8}$ inches above a base line formed by the bottom frame.

(b) The shape of the upper horizontal bar, which has a radius of $3\frac{3}{4}$ inches measured from a point $1\frac{1}{4}$ inches forward of the base line.

(c) The curve of the bottom frame which is on a radius of $4\frac{1}{8}$ inches, measured from a point 4 inches forward of the base line.

(5) The curve of the center vertical rod is established by a radius of $6\frac{3}{4}$ inches as measured from a point $1\frac{3}{4}$ inches forward of the vertical

base line and $\frac{1}{2}$ inch below the horizontal base line. The two side vertical rods are curved on a radius of $6\frac{1}{2}$ inches measured from a point $1\frac{1}{4}$ inches forward of the vertical base line and $1\frac{1}{4}$ inches below the horizontal base line (fig. 27).

(6) Additional dimensions are included on the drawings which indicate the overall size of the mask (fig. 27 and 28).

c. *Attachment of the Protective Face Mask to the Helmet* (fig. 28).

(1) The protective face mask is to be attached to the front of the helmet at three points, top center, right side, and left side.

(2) The attachment is to be made by means of 2-inch wide leather, industrial stock, $\frac{3}{16}$ inches

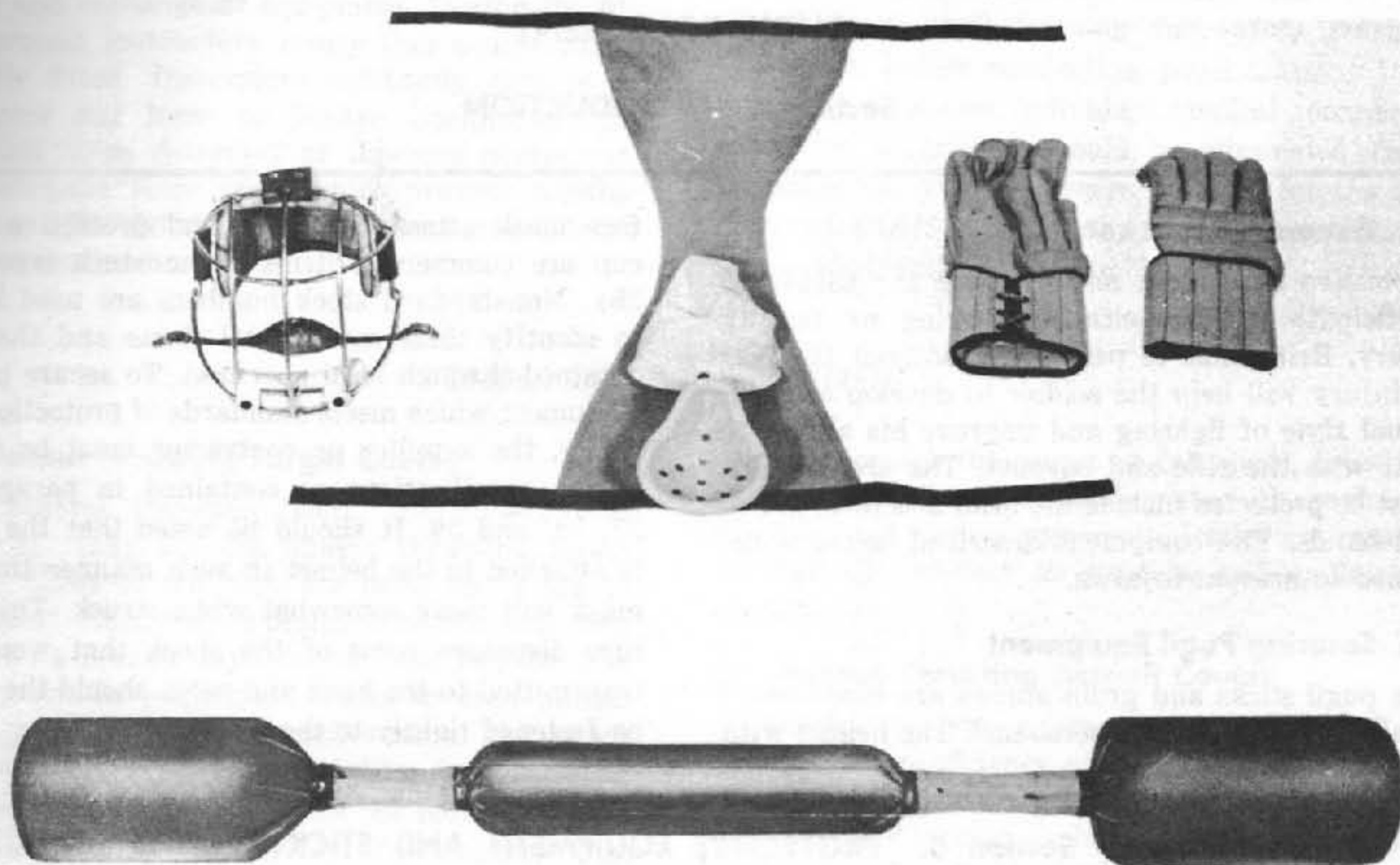

Figure 25. Pugil equipment.

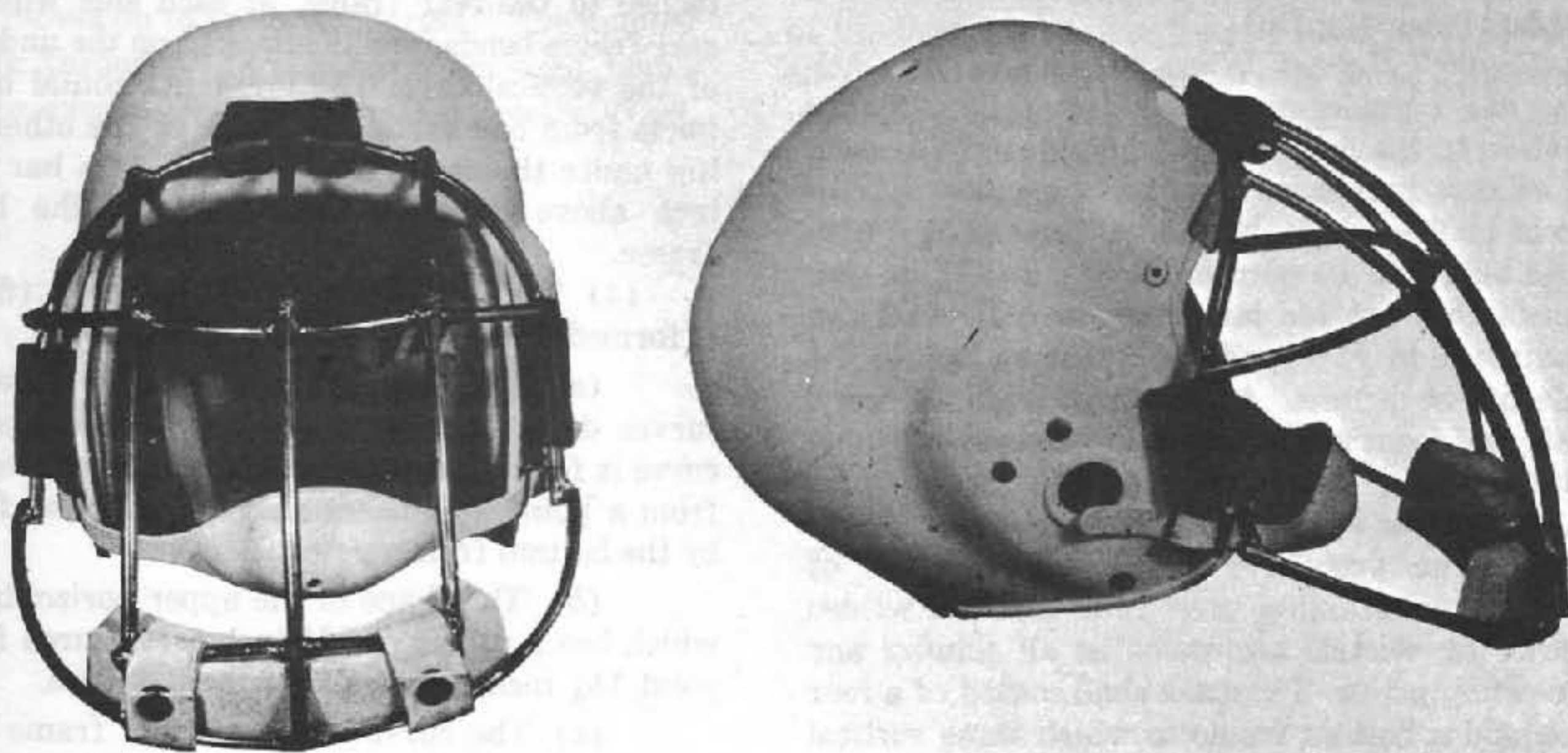

Figure 26. Pugil headgear.

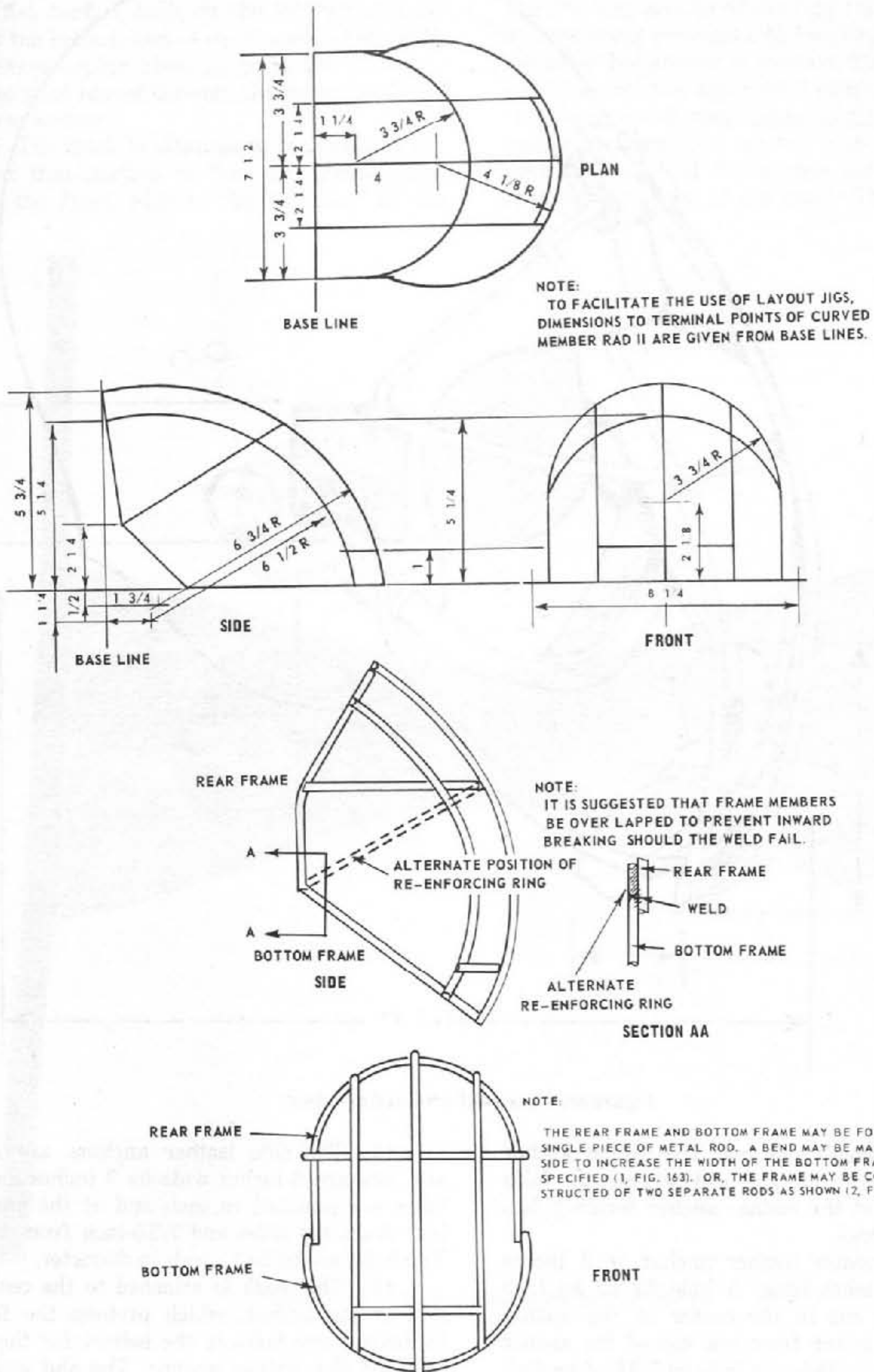

Figure 27. Face mask construction specifications.

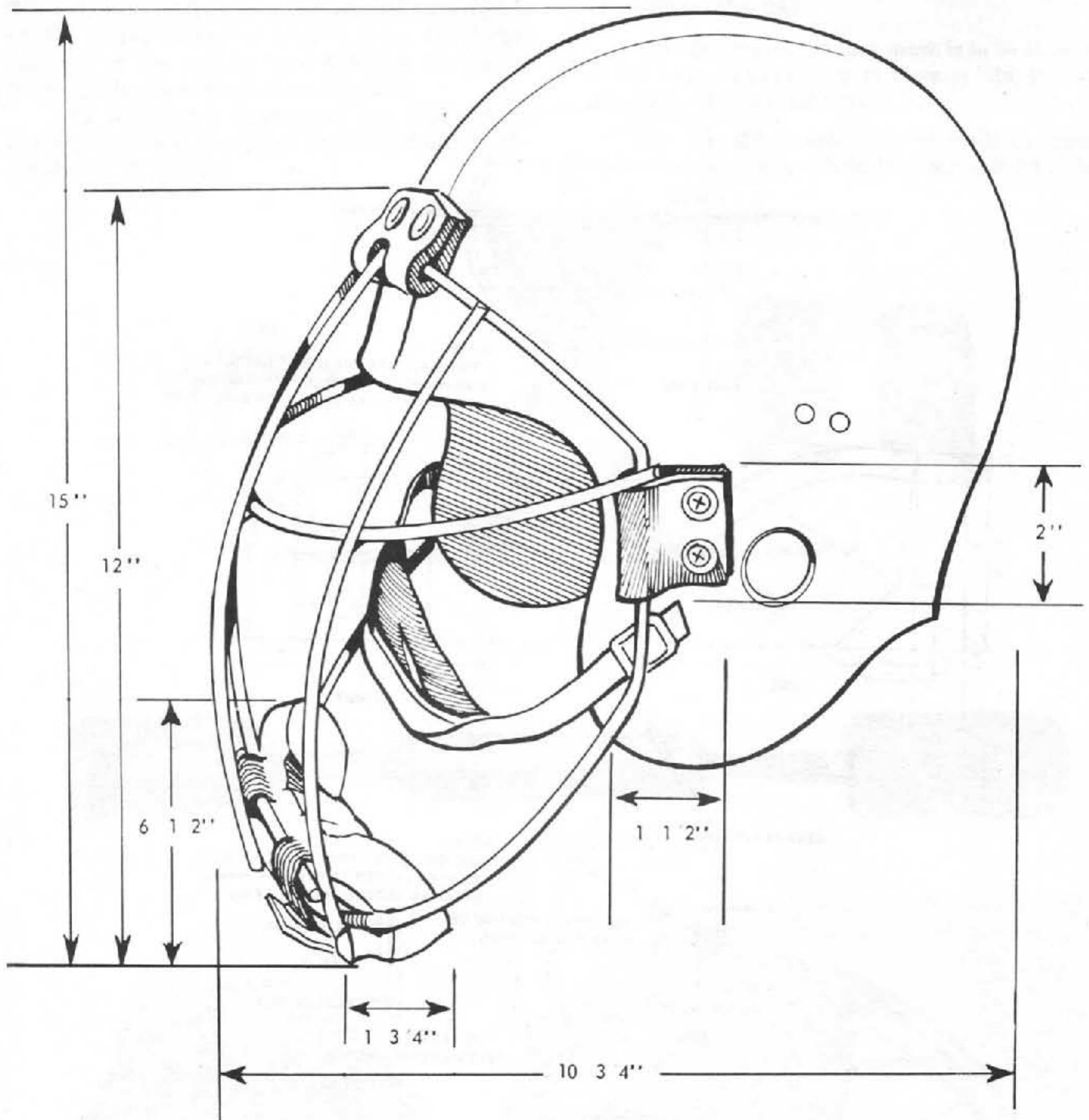

Figure 28. Face mask attached to helmet.

in thickness, smooth side out. The leather anchor is to be folded with the rod held between the folds and both ends of the leather anchor securely fastened to the helmet.

(3) The center leather anchor is 2 inches wide by $3\frac{1}{4}$ inches long. A hole $\frac{3}{4}$ of an inch in diameter is cut in the center of the leather anchor. A slot is cut from one end of the anchor to the center hole. This slot is to be $\frac{7}{16}$ of an inch wide. Four additional holes are punched, two at each end of the leather, $\frac{1}{2}$ inch from the sides and $\frac{3}{4}$ of an inch from the ends. These holes are to be of $\frac{1}{8}$ -inch diameter.

(4) The side leather anchors are identical and measure 2 inches wide by 3 inches long. Two holes are punched in each end of the anchor, $\frac{1}{2}$ inch from the sides and $\frac{7}{16}$ -inch from the ends. The holes are to be $\frac{1}{8}$ inch in diameter.

(5) The mask is attached to the center portion of the helmet, which protects the forehead, by boring two holes in the helmet for the attachment of the leather anchor. The slot end of the anchor is inserted over the center rod of the mask, and under the rear frame. The remaining end of the anchor then is folded so that the holes in both ends correspond with the holes in the helmet. The

anchor then is secured with two chase copper rivets and burrs. The rivet is diameter 10, length $\frac{5}{8}$ inch. Any other self-locking rustproof fastener that presents a flat surface both on the interior and exterior of the helmet, and of equal size and strength to the chase copper rivet as prescribed, may be used. The rivet passes through the helmet and both ends of the anchor.

(6) The mask is attached to each side of the helmet at that portion of the rear frame which parallels the front edge of the ear piece of the

helmet. The method of attachment of the mask to the helmet is designed to permit some movement of the mask when a blow is received on the mask. The $2\frac{1}{2}$ inch section of the rear frame at the place of attachment provides a $\frac{1}{2}$ inch exposed portion of rod after the anchor is secured. The anchor is attached so that the upper joint of this section or rod (the junction of rear frame and the upper horizontal rod) rests on the top edge of the anchor. Such placement of the anchor permits a $\frac{1}{2}$ -inch upward movement of the mask. The side anchors

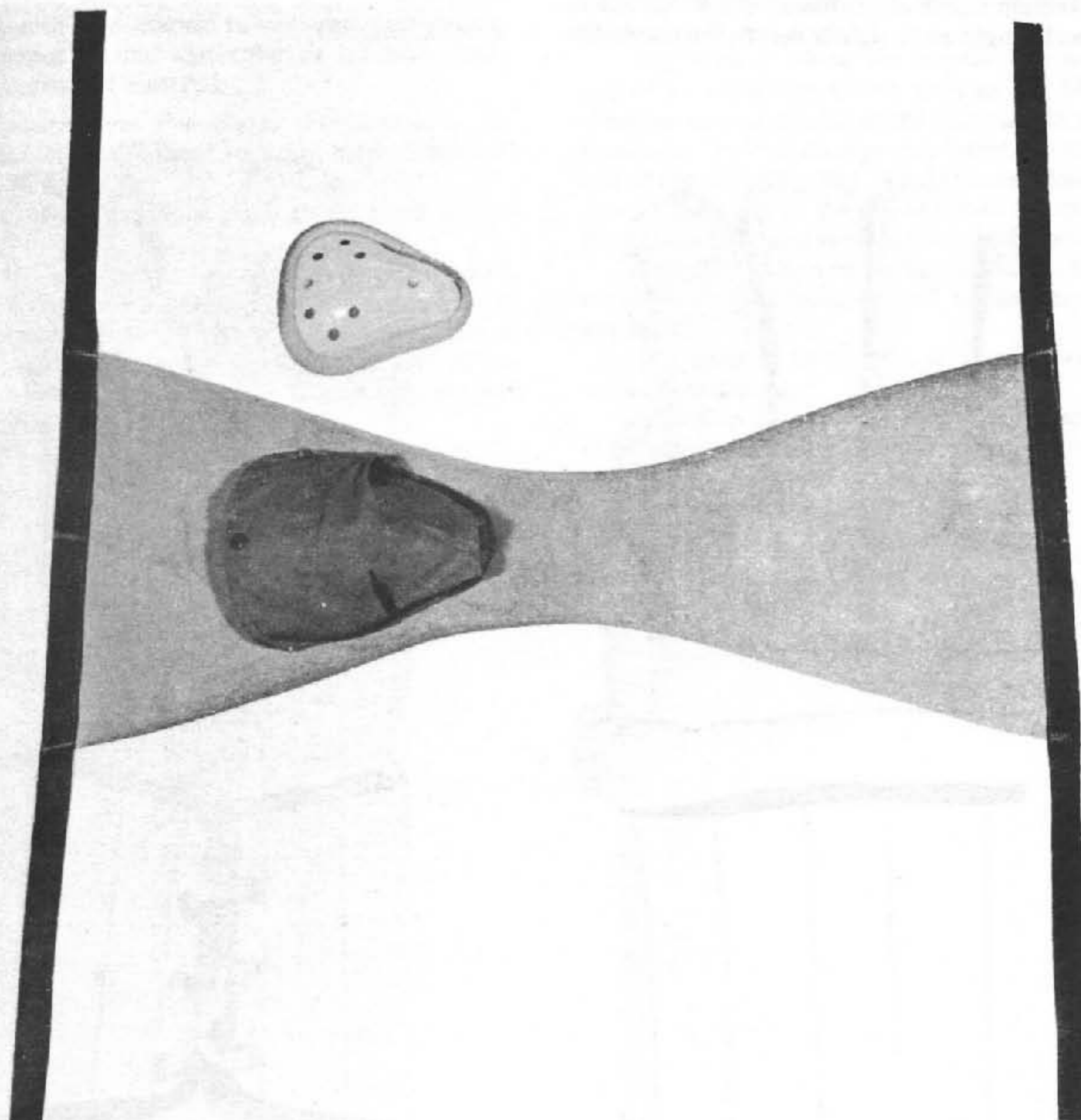

Figure 29. Canvas groin apron and protective cup.

are attached by the same method as prescribed for the center attachment, using the anchors as described in (2) above and the same type of fasteners as described in (5) above.

d. Mask Pad Specifications. A molded foam rubber mask pad (fig. 28) is to be attached to the lower portion of the mask. The rubber used in this pad is to measure $6\frac{1}{2}$ inches in length, $1\frac{3}{4}$ inches in width, and $\frac{3}{4}$ of an inch in thickness. The pad is to contain two canvas web straps $\frac{1}{2}$ inch in width with a metal snap on each strap for the attachment of the pad to the front lower portion of the bottom frame of the mask. The straps are to be of such length as to tightly secure the pad to the

mask. This pad protects the upper chest when the mask is forced inward by a frontal blow.

38. Groin Equipment

The groin is protected by a canvas apron which contains a protective cup of the variety used in athletic competition. It is worn over the outer clothing so that it can be put on and taken off quickly on the training field. Duck cloth cotton is recommended for use in making the apron. Material such as salvaged shelter halves and squad tents may be used provided that the fabric is still durable (fig. 29).

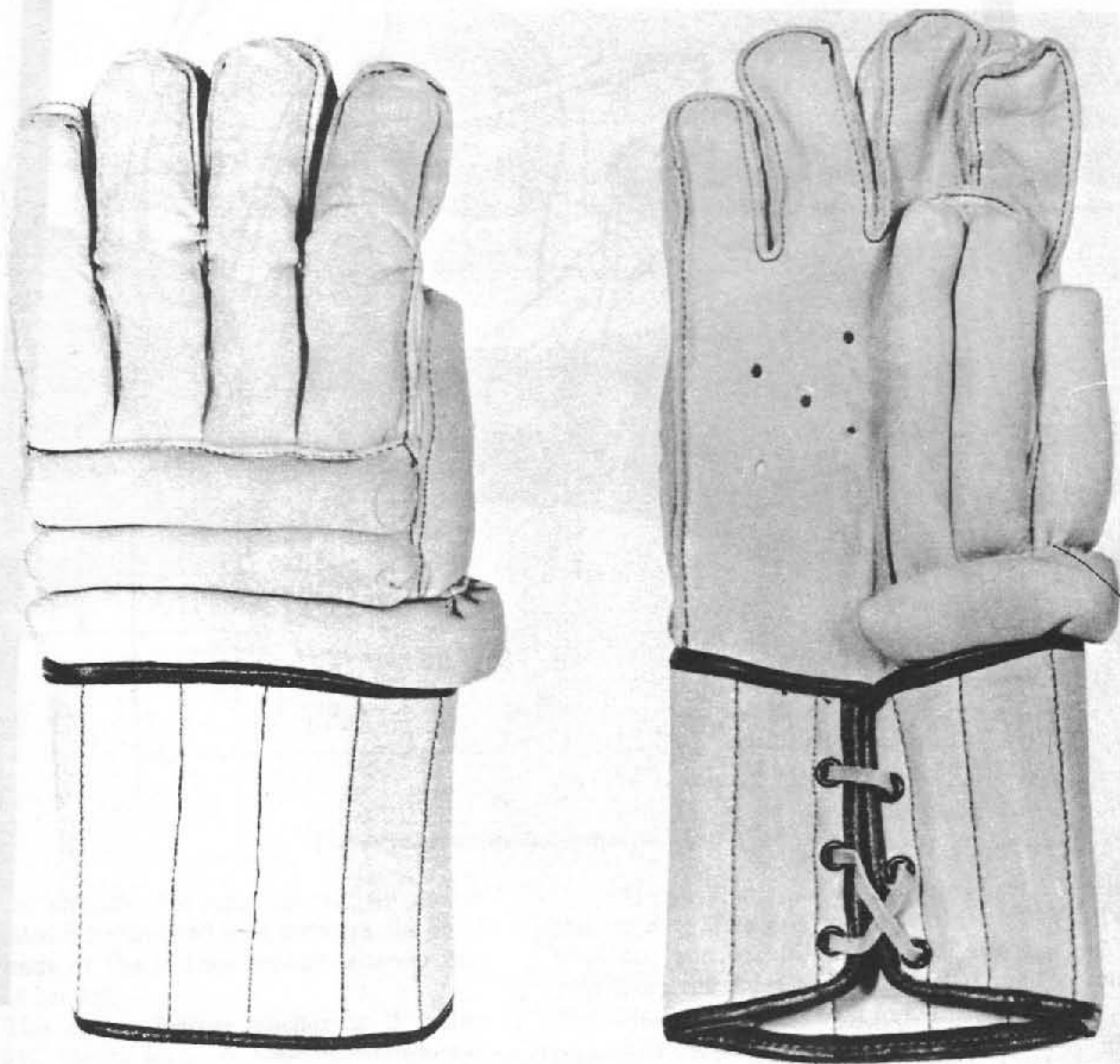

Figure 30. Lacrosse gloves.

39. Hand Equipment

Lacrosse gloves are recommended for use in pugil training. These gloves provide maximum protection for the fingers and joints of the hands and wrist and aid in controlling the stick (fig. 30).

40. Pugil Stick

a. General. Materials needed for the construction of the pugil stick are shown in figure 31. For further protection the center shaft of the pugil stick may be covered with sponge rubber leaving space for handholds. To make light sticks heavier, rubber such as contained in vehicle tire tubes, may be wrapped around the center of the stick under the sponge sheet material.

b. Construction Procedures. Steps used in the construction of the pugil stick are listed below and shown in figure 32.

(1) *Step 1.* Shape stick to required dimensions.

(2) *Step 2.* Lay a polyfoam sheet ($\frac{1}{2}$ -inch thick, 5 inches wide, and 4 feet long) on a flat surface and roll it as tight as possible. Roll two of these pieces and place one roll at each end of the stick. Apply rubber cement to the binding surface as you roll it.

(3) *Step 3.* To prepare the blade end of the

stick lay a thick polyfoam sheet ($\frac{1}{2}$ -inch thick, $1\frac{1}{2}$ feet wide, and 12 feet long), on a flat surface, apply rubber cement to the binding side, and roll as tight as possible around the core formed by the end of the stick and small polyfoam roll. Secure the roll with rubber bands. Let it dry for at least 24 hours (fig. 32).

(4) *Step 4.* To prepare the butt of the stick cut a polyfoam sheet to the tapered dimensions as indicated in figure 32 and then follow step 3 above.

(5) *Step 5.* Construct canvas bags 6 inches in diameter and 14 inches in length. Use the French stitch as shown in figure 32 for added strength in the seams.

(6) *Step 6.* Place the canvas bag over one end of an adjustable sleeve, such as No. 28 gauge sheet metal or stovepipe of the type used in military messhalls. On the opposite end, insert the polyfoam end of the stick (fig. 33). Apply the necessary pressure to the body of the sleeve; push the stick into the canvas bag; and remove the metal sleeve.

(7) *Step 7.* Secure the canvas bag to the stick with No. 4 screen tacks. Cut off excess canvas after assembly.

(8) *Step 8.* Cover No. 4 screen tacks with strip of cardboard.

(9) *Step 9.* Cover the strips (cardboard) with black plastic tape.

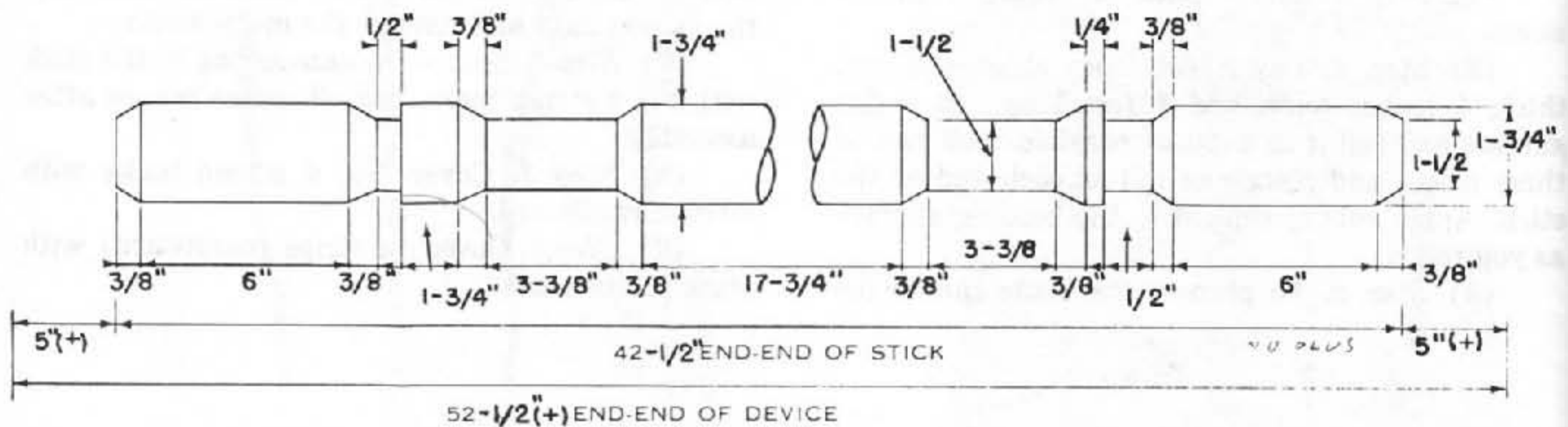
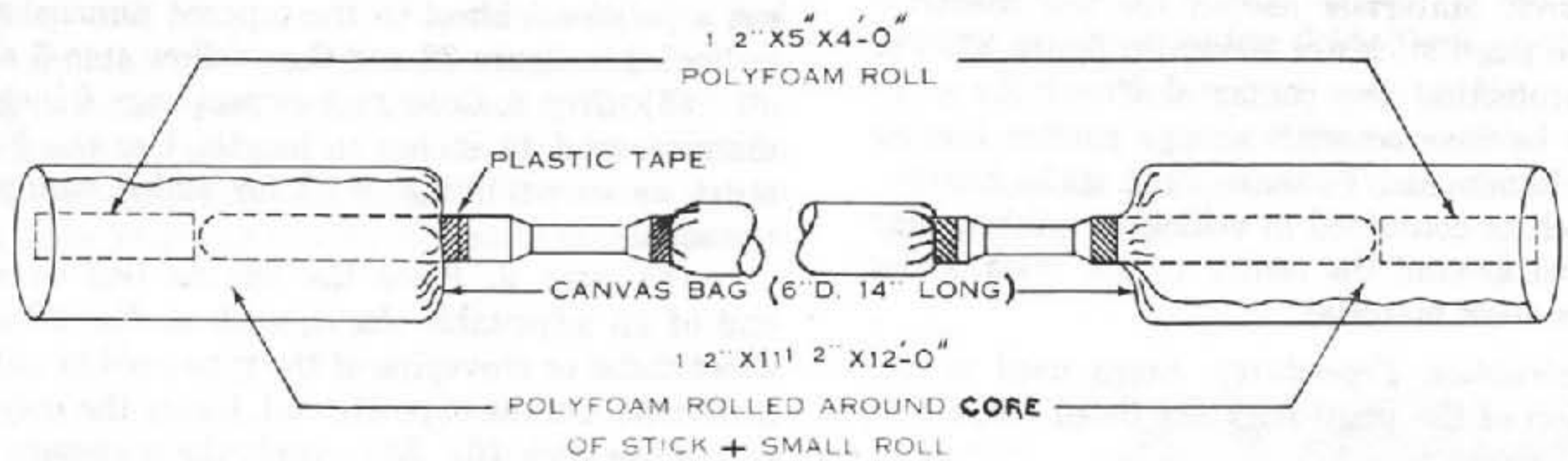

BILL OF MATERIALS

STICK: OAK, ASH, MAPLE OR HICKORY — 1 3/4'' X 42' 2'' — 1 PC
 POLYFOAM — 1 2'' X 5'' X 4'-0'' — 2 PCS
 POLYFOAM — 1 2'' X 11 1/2'' X 12'-0'' — 2 PCS
 (1 PC TAPERED FROM 11 1/2'' TO 8 1/2'')

UTILITY RUBBER CEMENT (COLOR NEUTRAL) — 1 PT
 NO. 4 SCREEN TACK — 24 EA
 CANVAS BAG (6'' D. 14'' LONG) — 2 EA
 CARDBOARD STRIP — 1 2'' X 6'' — 2 EA
 NO. 2 COATED NAILS — 10 EA
 PLASTIC TAPE — AS REQ'D

Figure 31. Materials needed for pugil stick construction.

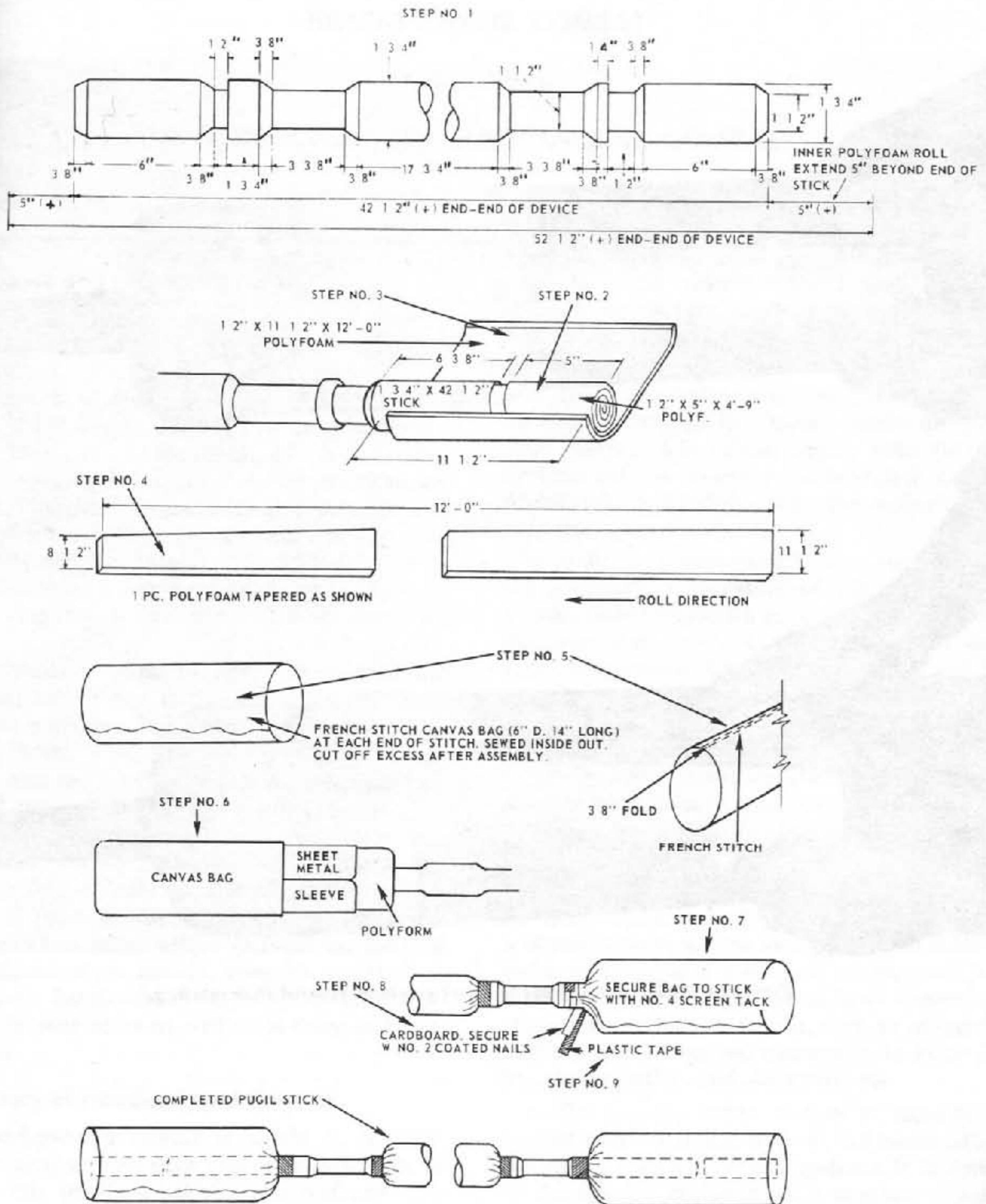

Figure 32. Steps in pugil stick construction.

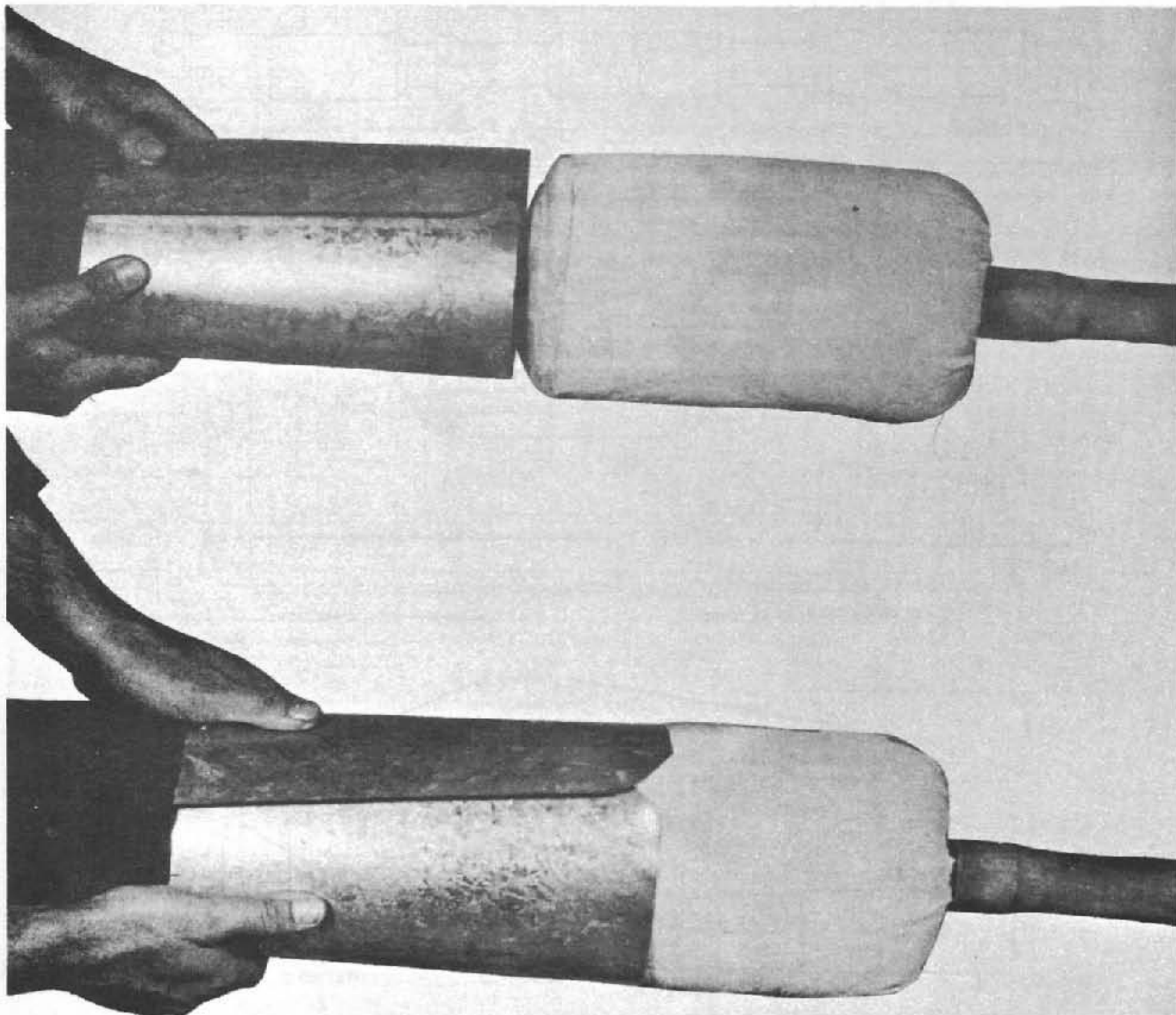

Figure 55. Using metal sleeve to insert polyfoam-covered stick into bag.

PART TWO

HAND-TO-HAND COMBAT

CHAPTER 5

INTRODUCTION TO HAND-TO-HAND COMBAT

Section I. INTRODUCTION

41. Purpose and Scope

Hand-to-hand combat is an engagement between two or more persons in a struggle with or without hand-held weapons. The average soldier, if trained only in the use of his basic weapon, loses his effectiveness if his weapon fails to fire, or if he should lose or break it. A knowledge of hand-to-hand fighting provides the soldier with another means of accomplishing his mission, and also permits him to defend himself if he is unarmed. Although the primary reason for training in hand-to-hand combat is to develop a proficient hand-to-hand fighter, this training has several other significant advantages.

a. It builds a spirit of aggressiveness in the individual soldier and instills the will to fight. It gives him confidence in his ability and develops his physical fitness.

b. It becomes another means of accomplishing assigned missions when the fighting becomes so intermingled between friendly and enemy personnel that firearms and grenades would be impractical to use for fear of injury to friendly troops.

c. It is valuable for night patrols and other occasions when silent attack is required. Because of the threat of air assault, guerrilla warfare, or infiltration, hand-to-hand fighting is taught to soldiers in rear areas as well as to those in front-line units.

42. History of Hand-to-Hand Combat

a. Hand-to-hand combat is as old as the first struggle between two cave men. For thousands of years it has provided soldiers and civilians with a means of defending themselves should they be attacked and no weapons were readily available for them to use.

b. It is believed that the first attempt to organize and develop hand-to-hand fighting techniques took

place in China around 3,000 B.C. The Chinese emperor at that time taught a method of unarmed defense to his subjects who were being harassed continually by outside invaders.

c. Historians believe a similar system of fighting also was developed by Tibetan monks during the 12th century A.D. These monks were forbidden by their religion to carry weapons, and a method of defense was needed to repel the robber bands of that era.

d. Both the Chinese and Tibetan forms of fighting are distant ancestors of modern judo and karate. Judo and karate generally are regarded by the American public as mysterious and deadly arts. They are difficult skills to learn and individuals must practice for great lengths of time before they become proficient in these martial arts. Army hand-to-hand techniques are simpler, and are better suited to our needs and to the time available for hand-to-hand combat training.

e. Very little hand-to-hand combat was taught to American soldiers during WWI. However, during WWII civilian-trained instructors worked with Army personnel to develop methods of unarmed attack and defense, as well as other related skills. The techniques consisted mainly of escapes from holds, application of holds, and methods of disarming an armed man. Specialized units, such as rangers and military police, received instruction in knife fighting, strangulation, and other subjects.

f. The present Army system of hand-to-hand combat, outlined in this manual, is a combination of the strong points of several systems. It is designed to provide the soldier with a number of actions which he can take if confronted by an opponent. The skills are not difficult to learn, and are very effective if properly applied. If mastered, they provide the soldier with a method of pressing his attack and disabling his opponent.

Section II. PRINCIPLES

43. General

There are three basic principles which apply to hand-to-hand fighting. These are balance, momentum, and leverage. In the execution of any fighting techniques, one or more of these principles must be used in order to successfully defeat an opponent. In the following paragraphs, these principles are outlined as objective guidelines for the individual fighter to follow.

44. Balance

a. Balance. Balance is a basic motor skill. It is the ability to resist the downward pull of gravity and maintain an upright position in everyday activities such as running or walking. This skill is of primary importance to an individual engaged in a struggle. When in an off-balance position an individual cannot press an effective attack or adequately defend himself from his opponent's attack. It is vital for the hand-to-hand fighter to understand balance in two important aspects:

(1) How to strengthen and maintain his balance during a struggle.

(2) How to exploit the weakness of the enemy's balance to his advantage.

b. Maintaining Your Balance. The procedures outlined in this manual consist of normal positions and simple movements. When executed properly and through constant practice, these movements will aid the fighter in maintaining his balance. Two general rules which will help the fighter to maintain and strengthen his balance are:

(1) *Keep a large base of support.* When assuming a guard position, always insure the feet are approximately shoulder width apart, either side-ward or from front to rear. The fighter always should remember that if his feet are too far apart his overall balance will be weakened; also, if his feet are positioned too close together his balance will be weakened from all directions.

(2) *Lower your center of gravity.* Flex your knees to lower the center of gravity, this will increase your stability and make it more difficult for your opponent to place you in an unbalanced position.

c. Exploiting Your Opponent's Weakness.

(1) The good hand-to-hand fighter will look for weak points in the opponent's defense and take full advantage of them by attacking ruthlessly to disable his opponent.

(2) The aggressive use of all available weapons will place your opponent on the defense. Once your opponent is on the defense, continue to press the attack until your opponent is disabled or has lost his will to continue the fight.

45. Momentum

a. Anytime your opponent's body is moving it possesses momentum. Momentum is the tendency of a moving object to continue moving unless stopped by another force.

b. You should apply this principle of momentum in hand-to-hand fighting. Use your opponent's momentum to your advantage. This momentum alone will not defeat him, but by using it against him you can put your opponent in a vulnerable position. For example, you can trip him while he is running, or step aside as he swings at you. In order for him to continue his attack he must stop his motion and turn to face you.

c. Always assume that your opponent is stronger than you, never oppose him directly in a test of strength. Instead, use his momentum to assist you in defeating him.

46. Leverage

a. Leverage, as it applies to the hand-to-hand fighter, is using some part of your body or your opponent's body as a lever in order to place your opponent at a definite disadvantage. For example, should your opponent extend his arm toward you in a striking motion, this will provide a part of his body to which you can readily apply leverage to disable him, or force him to the ground where he would be in a vulnerable position.

b. The hand-to-hand fighter also can use his body as a lever to place his opponent in a position to receive followup blows. For example, in the hip throw the fighter uses his own hip to support the weight of his opponent before flexing his knees and throwing his opponent to the ground.

Section III. VULNERABLE POINTS

47. General

Vulnerable points are areas of the body which are particularly susceptible to blows or pressure (fig. 34). Since your life is at stake, you should forget

any concept of fair play, and attack these vulnerable points. Striking your opponent in a vulnerable area may cause him to drop his defense temporarily, thus leaving him open to receive your follow-up blows to other parts of his body. The important

vulnerable points of the body are discussed below.

48. Vulnerable Points of the Head and Neck Region

a. *Eyes.* Blows to the eyes will cause temporary or permanent blindness and intense pain.

b. *Nose.* Blows to the nose cause intense pain and watering of the eyes.

c. *Ears.* Sharp, heavy blows can cause brain concussion. Lesser blows can cause shock or result in ruptured eardrums and internal bleeding.

f. *Temple.* Forceful hand blows to the temple may cause loss of consciousness and could result in death.

49. Vulnerable Points of the Trunk

a. *Collarbone.* A broken collarbone will cause intense pain and will disable the attached arm.

b. *Solar Plexus.* A sharp blow to the solar plexus will cause shock, breathlessness, and possible internal injuries.

c. *Stomach.* A sharp blow to the stomach also will cause breathlessness and possible internal injuries.

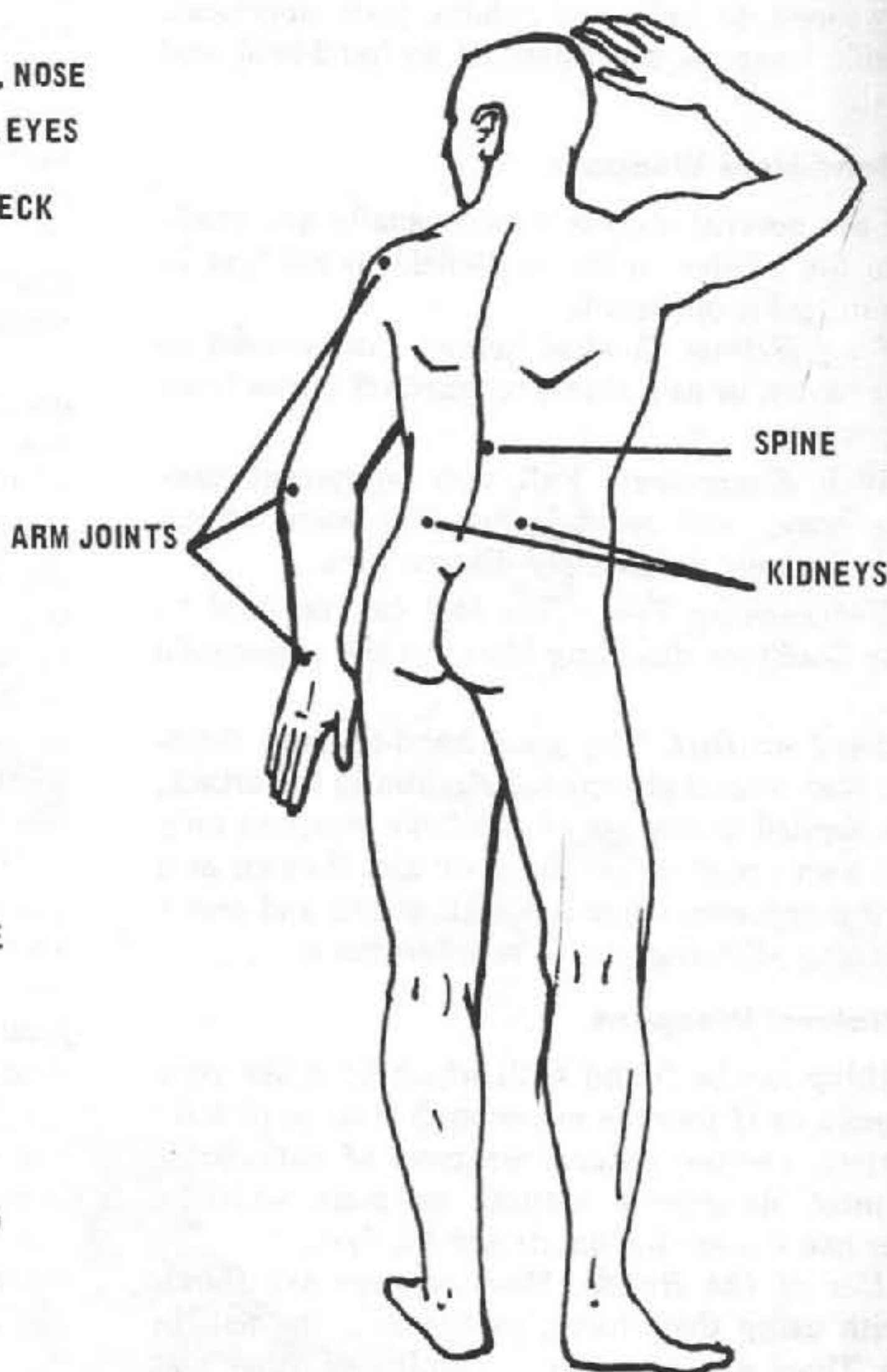
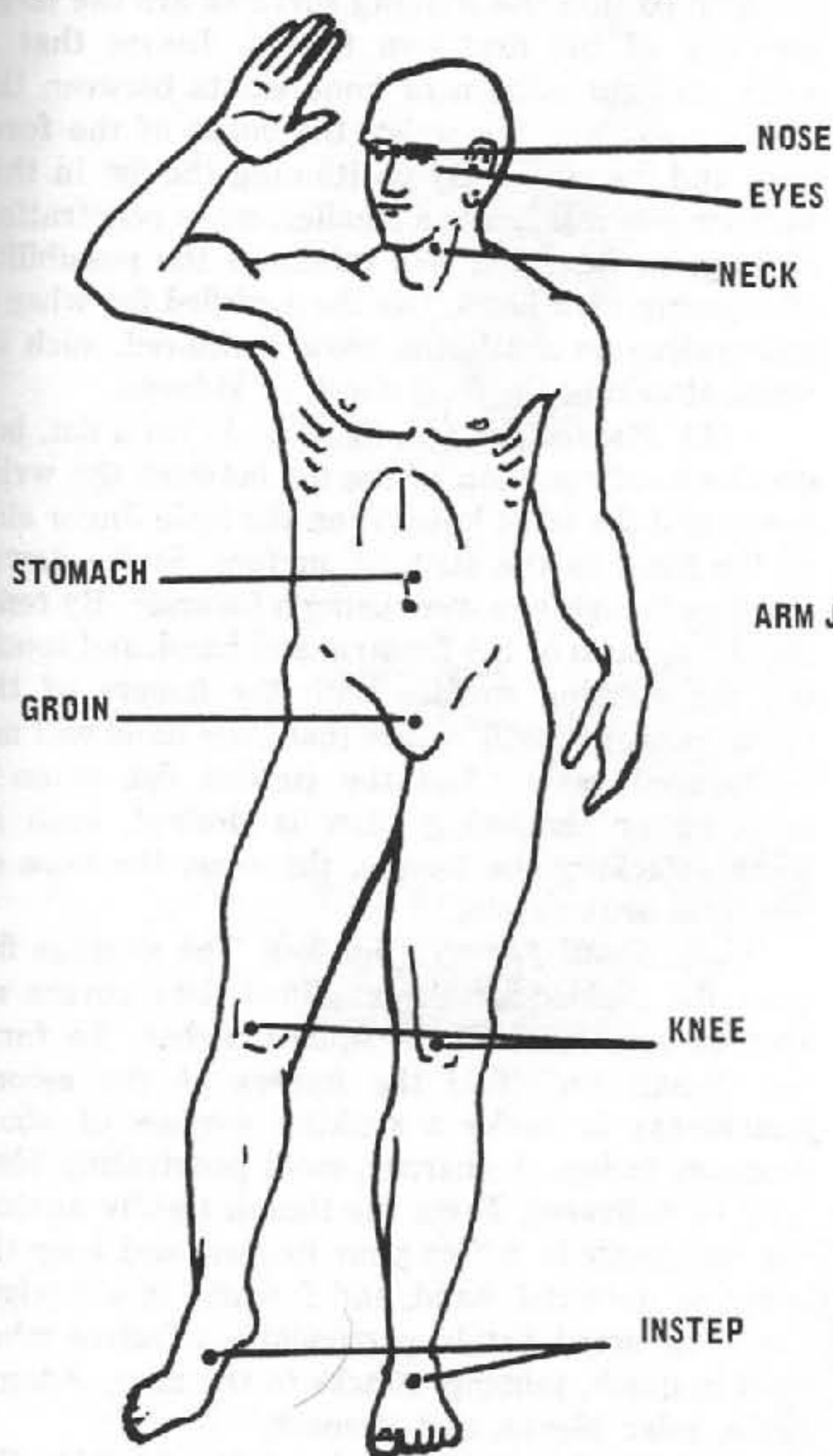

Figure 34. Vulnerable parts of the body.

d. *Nape of the Neck.* A blow to the nape of the neck may cause temporary loss of consciousness. If you strike with great force you can break his spine.

e. *Adam's Apple.* A blow to the Adam's apple usually causes pain and breathlessness. If such a blow is delivered forcefully, the Adam's apple may be crushed and the opponent will strangle.

d. *Kidneys.* Forceful blows to the kidneys will cause intense pain, shock, and internal injuries.

e. *Spine.* Vigorous blows can dislocate the vertebrae of the spine, pinching or severing the spinal cord, and causing intense pain or paralysis.

f. *Groin.* The groin is a very accessible target. Striking the groin will cause extreme pain and disability.

50. Vulnerable Points of the Limbs

Blows to the limbs will cause intense pain and disability.

a. Arms. Using blows it is difficult to disable the arms of a standing opponent. The bones of his

arms and hands can be broken by using certain procedures discussed later in this manual.

b. Legs. A kick to the shin is very painful. The small bones of the ankle and foot can be broken, crippling your opponent. The knee bends in only one direction, and its tendons and cartilage can be torn by kicks to the side or front of the knee.

Section IV. AVAILABLE WEAPONS

51. General

In hand-to-hand fighting your life is always at stake, therefore, you must use any available object as a weapon to help you subdue your opponent. Available weapons are classified as hand-held and natural.

52. Hand-Held Weapons

There are several objects which usually are available to the soldier on the battlefield to aid him in overcoming his opponent.

a. Steel Helmet. A steel helmet can be used to deliver blows, or as a shield to ward off blows from the opponent.

b. Web Equipment. Full web equipment usually is heavy and could be used to ward off an armed opponent or possibly disarm him.

c. Entrenching Tool. This tool can be used to deliver deadly or disabling blows to the opponent's body.

d. Sand or Dirt. The good hand-to-hand fighter can find several objects to help him in his attack, and is limited in the use of available weapons only by his own imagination. Sand or dirt thrown at a charging opponent could upset his attack and create an opening allowing you to counterattack.

53. Natural Weapons

If nothing can be found with which to strike your opponent, or if there is not enough time to pick up an object, use the natural weapons of your body. The most dangerous natural weapons which a soldier can use are his hands and his feet.

a. Use of the Hands. Most soldiers are familiar with using their hand, particularly the fist, in fights. There are, however, a number of other and more effective weapons which can be formed by the hand. Each of these weapons is suited for attacking certain vulnerable parts of the body. The fighter should be familiar with these weapons, and be able to select and use that weapon which is most suited to the particular situation. These weapons are described below and their effective employment is discussed.

(1) *Modified fist* (①, fig. 35). Make a fist as you normally would, with the thumb curled between

the second and third knuckles of the fingers. However, position the fist in relation to the wrist and forearm so that the striking surfaces are the large knuckles of the first two fingers. Insure that a solid, straight column of bone exists between the striking surface, the wrist, the bones of the forearm, and the elbow. By positioning the fist in this manner you will create a smaller, more penetrating striking surface, and will minimize the possibility of injuring your hand. Use the modified fist when a penetrating or shattering blow is desired, such as when attacking the face, chest, or kidneys.

(2) *Padded fist* (②, fig. 35). Form a fist, but use the meaty portion of the fist between the wrist bones and the large knuckle on the little finger side of the hand as the striking surface. Strike downward as though you were using a hammer. By tensing the muscles of the forearm and hand, and touching the striking surface with the fingers of the other hand, you will realize that your hand will not be injured easily. Use the padded fist when a crushing or shattering blow is desired, such as when attacking the temple, the nose, the nape of the neck, or the groin.

(3) *Small fist* (③, fig. 35). The average fist (not the padded or the modified fist) covers an area of approximately 8 square inches. To form the "small fist" fold the fingers at the second knuckle(s) to make a striking surface of about 4 square inches. A sharper, more penetrating blow may be delivered. Press the thumb tightly against the forefinger to stiffen your fingers, and keep the bones of the wrist, hand, and forearm in a straight line. The small fist is particularly effective when used in quick, jabbing attacks to the nose, Adam's apple, solar plexus, and stomach.

(4) *Knife edge of the hand* (④, fig. 35). Extend and join the fingers and position the thumb beside and slightly above the forefinger. Do not strike with the little finger because it may be broken. Strike with the meaty portion of the little finger edge of the hand, between the first knuckle of the little finger and the bones of the wrist. The knife edge of the hand is used effectively when a penetrating or shattering blow is desired, such as when attacking the nose, nape of the neck, Adam's apple, collarbone, spine, or kidneys.

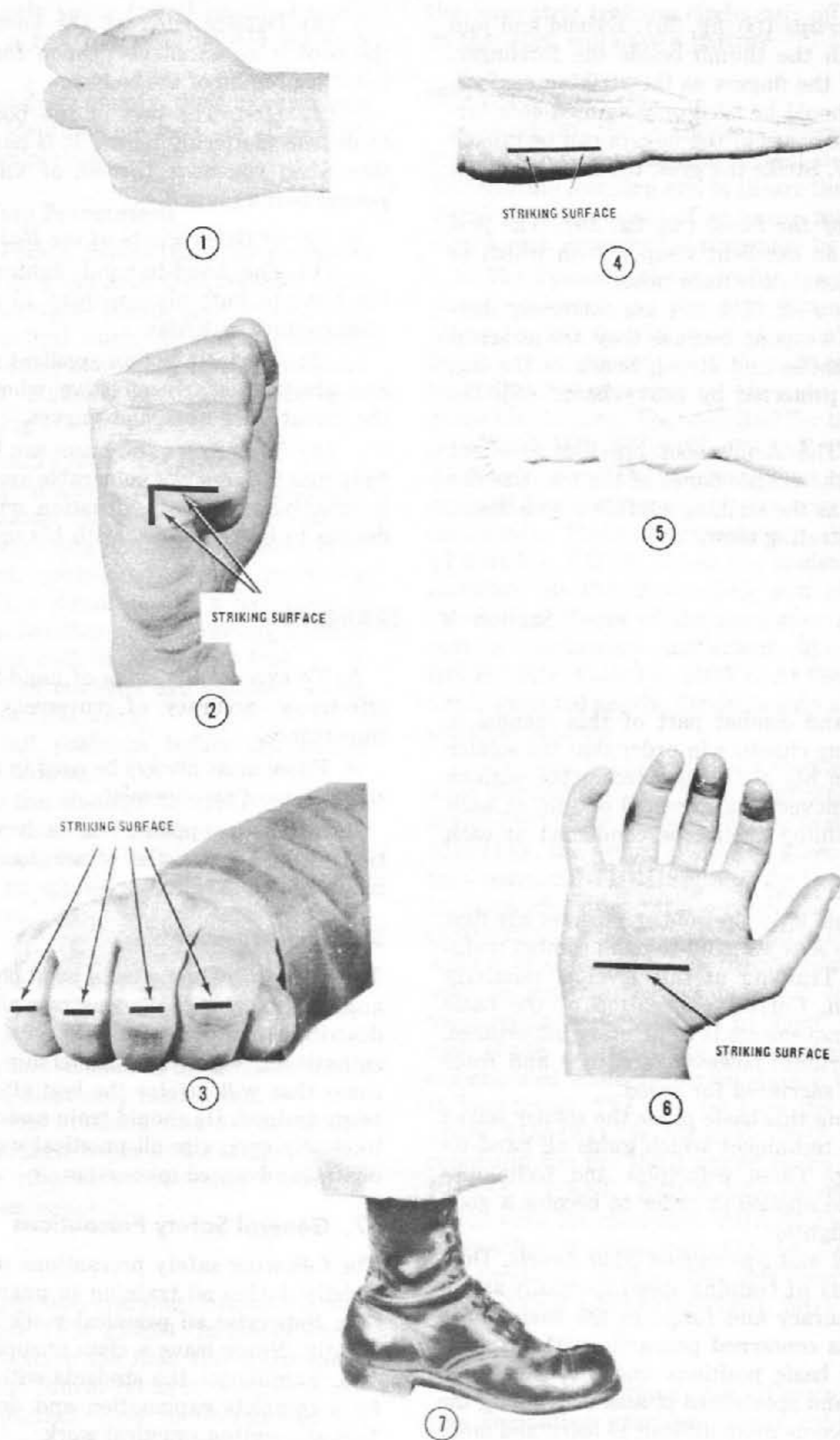

Figure 35. Natural "weapons."

(5) *Fingertips* (⑤, fig. 35). Extend and join the fingers with the thumb beside the forefinger. Use the tips of the fingers as the striking surface. This weapon should be used only against soft targets because the bones of the fingers can be broken relatively easily. Strike the eyes, the Adam's apple, or the stomach.

(6) *Heel of the hand* (⑥, fig. 35). The heel of the hand is an excellent weapon with which to strike your opponent's chin or nose.

b. Use of the Feet. The feet are extremely dangerous natural weapons because they are attached to powerful muscles and strong bones in the leg. They are also protected by heavy boots (⑦, fig. 35).

(1) *Toe.* The Army boot provides excellent protection for the fragile bones of the toe. Use the toe of the boot as the striking surface if you desire to strike a penetrating blow.

(2) *Outside edge of the boot.* The edge of the boot is an excellent weapon for attacking the lower leg region of the body.

(3) *Heel.* The heel of the boot can be used to deliver shattering blows. It is particularly effective when you have thrown or knocked your opponent to the ground.

c. Use of Other Parts of the Body as a Weapon.

(1) The hand-to-hand fighter also can use his head to butt his opponent in order to break close contact with him.

(2) The teeth are an excellent natural weapon and are particularly effective when used against the throat, face area, and fingers.

(3) The elbows and knees can be driven forcefully into the enemy's vulnerable area and are highly effective when in a situation where the fighter desires to break contact with his opponent.

Section V. TRAINING

54. General

The hand-to-hand combat part of this manual is divided into four chapters in order that the soldier can progress in his ability to execute the various positions and movements expected of him at each skill level. Training should be conducted at each level.

a. Basic Skill Level.

(1) At this level the soldier receives his first insight into the Army's hand-to-hand combat training program. Training at this level is relatively simple to learn. Correct application of the basic positions and movements is of primary importance. Speed is important; however, accuracy and force must never be sacrificed for speed.

(2) During this basic phase the soldier learns principles and techniques which guide all hand-to-hand training. These principles and techniques must always be applied in order to become a good hand-to-hand fighter.

b. Advanced and Specialized Skill Levels. During this level(s) of training speed is equally as important as accuracy and force. In the basic phase the soldier was concerned primarily with learning and executing basic positions and movements. In the advanced and specialized phases of training the movements become more difficult to learn and more time should be devoted to training than was allotted during the basic phase.

55. Major Points to Remember in Hand-To-Hand Training

a. Always use the principles and techniques of hand-to-hand fighting as outlined in this manual.

b. To execute the skills of hand-to-hand combat effectively, accuracy of movement is of primary importance.

c. Force must always be used in order to control the actions of an opponent.

d. When an opponent is in a vulnerable position, always press the attack by using followup blows to disable him.

56. The Instructor

The instructor should be in good physical condition and must be able to demonstrate all the maneuvers described in this manual. He must display intense enthusiasm, vigor, and leadership qualities at all times that will inspire the best efforts of the men being trained. He should train assistant instructors to closely supervise all practical work and to demonstrate advanced maneuvers.

57. General Safety Precautions

The following safety precautions must be followed strictly during all training in unarmed combat.

a. Supervise all practical work closely and constantly. Never leave a class unsupervised.

b. Familiarize the students with each maneuver by a complete explanation and demonstration before attempting practical work.

c. During the learning stages, do not let the students get ahead of your instruction. This prevents accidents.

d. During the stages of learning and perfecting techniques, the training partner offers no resistance. He should allow the maneuver to be executed freely.

e. Insure adequate space for all practical work. A space at least 8 feet square is needed for each pair of students.

f. Have the students empty their pockets and remove jewelry, identification tags, or glasses before practical work periods.

58. Specific Safety Precautions

a. *Vulnerable Points.* Stress that only simulated blows to the eyes or groin area are executed. Light blows to other vulnerable points may be used during the initial practical work. As students become more advanced, harder blows may be used. In order to avoid injuries, students must always be cautioned against using excessive force.

b. *Fall Positions, Throws, and Holds.*

(1) Establish a signal that can be given by the individual student to stop the application of pressure when practicing holds. All students must know this signal, particularly when practicing strangle holds. This signal can be a handclasp if hands are free; a handtap on his training partner might be used when both hands are not free.

(2) Be sure all students are warmed up before doing any practical work.

(3) Teach fall positions before conducting practical work in throws.

(4) Caution the students to apply very light pressure until they become familiar with the holds. Strangle holds should never be applied with force. Other holds may be applied with more pressure as training progresses.

c. *Disarming.*

(1) While the men are learning bayonet disarming methods, keep scabbards on and the bayonet firmly attached to the rifles.

(2) Use bayonet scabbards to simulate knives while giving knife disarming instruction.

(3) Caution the students who are to be disarmed not to place their finger in the trigger guard of their pistol or rifle while practicing disarming methods with these weapons.

59. Formations

a. Regulation physical training formations may be used for practice (FM 21-20). In the extended platoon formation have the first and third ranks face the second and fourth ranks so that each student will have a partner. Even numbered students do not uncover. It is recommended, when practicing throws, that twice the normal distance be taken between ranks.

b. To instruct disarming methods, it is recommended that the instructor use a formation of two concentric training circles or a formation that employs only two well-extended ranks. In forming

the concentric training circle, pair off the students so that each will have a partner.

60. Commands

a. Most of the maneuvers described in this manual can be divided into several steps or phases. To facilitate learning and to insure that the student learns each movement of an entire maneuver accurately, each maneuver is presented by phases.

b. For example, the right hip throw is a three-phase maneuver. In the first phase the student places his left foot in front of and slightly to the inside of his opponent's left foot. At the same time, he strikes his opponent on his right shoulder and grabs his clothing. The command for this movement is RIGHT HIP THROW, PHASE ONE, MOVE. At the command MOVE the student executes phase one and holds his position until given subsequent commands. These commands are PHASE TWO (THREE), MOVE. When the student has become proficient in the movements, you can work for speed. The phases of the maneuver are combined into a continuous movement by commanding RIGHT HIP THROW, MOVE. At first, the maneuver is executed slowly. Students gain speed through constant practice.

c. Paragraph 115 explains a counter against the long bayonet thrust. This disarming method is divided into four phases. For the first phase (para 115b(1)), the armed student is given the preparatory command THRUST, and the unarmed student is given the preparatory command OVER LEG COUNTER, PHASE ONE, MOVE. Since you want both students to halt their movements and remain in position for a subsequent command, you must remind your students to "hold" at the end of each phase. The next two phases of the movement are executed while the armed student is extended in the long thrust. The command for the second phase (para 115b(2)), is PHASE TWO, MOVE. The command for the third phase (para 115b(3)), is PHASE THREE, MOVE. The movement is completed with the command, PHASE FOUR, MOVE, as specified in paragraph 115b(4), (5) and (6). The command for executing this disarming maneuver is OVER LEG COUNTER, MOVE.

61. Exercise

a. *Recommendations for Warmup Exercises.* Use combative exercises, grass drills, and tumbling exercises to warmup your men. The aggressive nature of these warmup drills lends itself to the spirit of hand-to-hand combat (FM 21-20).

b. *Recommended Drill for Parry Exercises.* It is important that your students be trained in the bayonet disarming parry movements before practicing the disarming methods. To do this, have the

paired students assume their respective guard positions with the chin of the unarmed men 6 to 8 inches from the bayonet point. The armed student stands fast in the guard position during the entire exercise. The unarmed student, on command, parries the bayonet first to the right and then to the left. As he parries to the right, he sidesteps to his left oblique with his left foot, brings his right foot slightly to the rear of his left, and faces the side of the rifle. When he parries left, he sidesteps with his right foot to his right oblique.

62. Training Pit

a. The most suitable area for teaching fall positions, throws, and counters is a sawdust pit. You can obtain sawdust at most military installations. Figure 36 shows a training area with a sawdust pit surrounding an instructor-demonstrator platform. The pit will accommodate 100 pairs of students.

Fill the area with sawdust. Do not use wood shavings because they tend to settle and form a hard surface.

c. Build a demonstration area, 14 feet square, in the center of the pit area. Construct retaining walls with sandbags, four bags high, and fill the inside with sawdust. This platform is big enough to hold two demonstrators and the instructor.

d. The students gather around the platform to watch the demonstrations.

63. Other Training Areas

a. Any large grassy or sandy area is suitable for work in disarming methods and throws. Students should be taught fall positions before performing throws on a hard, grassy area.

b. Classes in unarmed combat can also be conducted indoors, but the floors and walls should be matted. An area 8 feet square should be allotted for

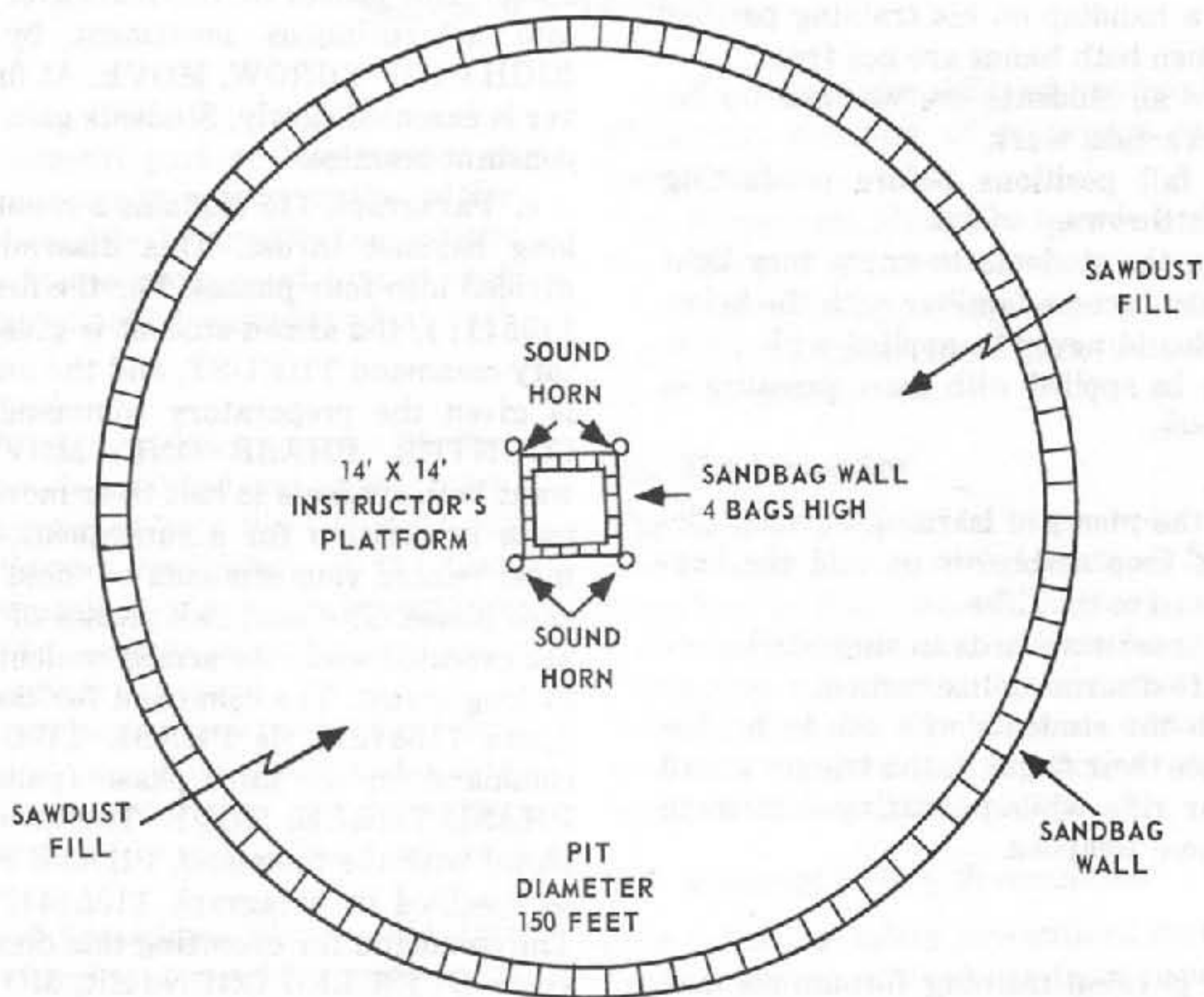

Figure 36. Hand-to-hand training pit.

b. To construct a pit dig out the pit area to a depth of 18 inches or build a retaining wall of dirt or sandbags 18 inches high around the pit area.

each pair of students. The difficulty indoors is that only a small group of men can participate at one time as most indoor areas are restricted in size.

CHAPTER 6

BASIC HAND-TO-HAND COMBAT

Section I. INTRODUCTION

64. Purpose

Application of the basic system of hand-to-hand combat is designed for the basic combat trainee or for the soldier who has received no previous hand-to-hand combat instruction. The skills of this system are simple to learn and proficiency can be maintained with a minimum of practice.

65. Scope

This chapter outlines the techniques of basic hand-to-hand combat and stresses simple, aggressive tactics with which to subdue an opponent. It describes the various kicks, blows, takedowns, counters, and other movements used to disable or kill an opponent in hand-to-hand fighting. Because the basic skills are few in number and are simple in nature, these skills are appropriate to the training schedule allowances for hand-to-hand combat instruction during the basic phase of combat training.

66. Aggressive Action

a. The most successful hand-to-hand fighter uses an aggressive approach. He strikes with speed and surprise and at the same time employs the principles of balance, momentum, and leverage. When confronted with an unarmed opponent you initially should remain outside of the range to be grasped or struck by him. At the same time you should maneuver into position to deliver an aggressive kicking attack. If the opponent's ability to attack is not destroyed or upset and the distance is closed to eliminate the possibility of kicking, then a takedown or blow to a vital area must follow quickly.

b. The opponent's approach can determine your course of action. For example, if he is armed with a rifle and bayonet, or possesses another hand-held weapon, you must take different action than if he were unarmed. Likewise if no opportunity occurs for kicking you must take other action to attack.

Section II. BASIC POSITIONS AND MOVEMENTS

67. General

In order to maintain your balance and provide yourself with all-round protection, there are guard positions which must be mastered. Two factors control the selection of the guard position to be used; first is your choice of offensive maneuver, and second is the desired degree of protection to your vulnerable areas.

68. Guard Positions

a. *Objective and Use.* The objective of a guard position is to be alert and in the proper position to execute the desired maneuver. Guard positions are assumed any time a protective and ready position is appropriate.

b. *Description: Side Guards.*

(1) *Right guard.* To assume the right guard position, the right side of the body is facing your opponent; feet are spread shoulder width apart; the toes are pointed directly to the front; knees

flexed; and body held erect. The arms are flexed with the forearms at a 45° angle, right arm leading, left arm held in front of the neck region. The fingers are extended and joined; eyes are on your opponent. The majority of the body weight is placed on the left foot (①, fig. 37).

(2) *Left guard.* The left guard position is the same as the right guard position except that the left arm is leading, right arm in front of the neck region, and the majority of the body weight is on the right foot (②, fig. 37).

(3) *Front guard.* To assume the front guard position, face directly toward your opponent, spread your feet shoulder width apart with your left foot and heel of that foot generally on line with your right toe. Bend your body forward slightly at the waist and flex the knees. Hold the hands approximately 6 inches in front of the face with the fingertips at eye level. The knife edges of your hands are leading with the palms facing in-

ward (fig. 38). This position is similar to a boxer's crouch. If you are left-handed, reverse this position and bring your left foot to the rear and your right foot forward.

c. Changing Guard Positions. Some maneuvers are best executed from the side guard (right or left), and others from the front guard. As a general rule kicks are delivered most effectively from a side guard and throws and takedowns are accomplished best from the front guard. To change guard position the following appropriate action is taken.

(1) *Rear guard movement.* In order to meet an opponent approaching from your rear, you must reverse quickly your right or left guard position. This is accomplished by quickly reversing the position of your arms and head to face the new direction. The weight of your body is shifted to the rear foot at the same time the head and arms are moved.

(2) *Move from side guard to front guard.* It is a simple matter to move from either the right or left guard position to the front guard. To change position pivot on the ball of the front foot and move the rear foot forward to the position as prescribed for the front guard, also adjust the position of the hands accordingly. To change from front guard to right guard, move your right foot forward, turn the right side to your opponent, and

adjust the position of your hands. To change from front guard to left guard reverse the procedure.

d. Instruction and Commands. Guard positions are taught as whole movements. When ready for practice, the command RIGHT GUARD, LEFT GUARD, or FRONT GUARD is given as desired. The command REAR GUARD is used to face to the rear from either right or left guard positions. To move from a side guard to front guard or vice versa, simply command the desired guard position to be assumed. For example, to change from front guard to right guard, the command is RIGHT GUARD.

69. Glide

The glide is a movement used to gain distance from or to close with your opponent. To gain distance from your opponent, take a long step away from him and immediately slide your leading foot back into the proper position. To close with your opponent, take a stride toward him and slide your trailing foot forward into the proper position. Always assume a guard position after each movement. The glide is not a hop; always try to maintain contact between the ground and the balls of your feet. All movements should be executed quickly and smoothly. The commands are REAR GLIDE, MOVE, to gain distance from an opponent, and FORWARD GLIDE, MOVE, to close with the opponent.



Figure 37. Right and left guards.



Figure 38. Front guard position.

70. Kicks and Stomps

The most dangerous natural weapons a man possesses are his feet and hands; kicks generally form the frontline of the attack. Other skills are taught to be used when the kick fails or is inappropriate. Every attempt is made to maintain kicking distance in any encounter with an opponent. If the opponent is allowed to close and grapple, as in judo or wrestling, the larger and/or stronger of the opponents will have the advantage.

71. Side Kick

a. Objective and Use. The objective is to bring the opponent to the ground with a kick to the groin or stomach region. This kick is used when the opponent is facing you with the front of his body unguarded.

b. Description. The side kick may be executed from either the right or left guard position (①, fig. 39). In executing this kick, the knee is pulled up in a flexed position, pointed toward your opponent (②, fig. 39). The kick is delivered forcefully at the groin region by fully extending the knee and ankle in a rapid movement (③, fig. 39).

c. Followup or Recovery. The leg should return as quickly as it went out and should travel through the same path. Speed of the return is important to prevent your opponent from catching your foot. If you diverted his attack but failed to bring your opponent down, recover and kick again.

d. Instruction and Commands. This kick is taught in two phases.

(1) SIDE KICK PHASE ONE, MOVE; on this command the trainee kicks and holds (his foot off the ground).

(2) PHASE TWO, MOVE; on this command the foot is returned to the ground and the guard position is resumed. At normal speed the command is SIDE KICK, MOVE.

72. Pivot Kick

a. Objective and Use. The objective is to bring an opponent to the ground with a kick to the groin or stomach region. The pivot kick is used when the opponent's groin region is turned to the side and guarded. The pivot kick may be executed from either guard position. The proper guard position to assume is determined by the direction in which the opponent is facing. This kick is more powerful than the side kick and can be executed at a greater distance from your opponent.

b. Description. To execute this kick from the right guard position (①, fig. 40) pivot sharply to the right on the right foot, at the same time draw-



Figure 39. Side kick.

The first step in the pivot kick is to assume the fighting stance. The feet are placed shoulder-width apart, with the front foot slightly ahead of the back foot. The hands are held in a ready position, with the fingers curled and the thumbs pointing downwards. The body is slightly hunched forward, and the head is kept in line with the spine. This stance provides a stable base for the kick and allows for quick movement in any direction.

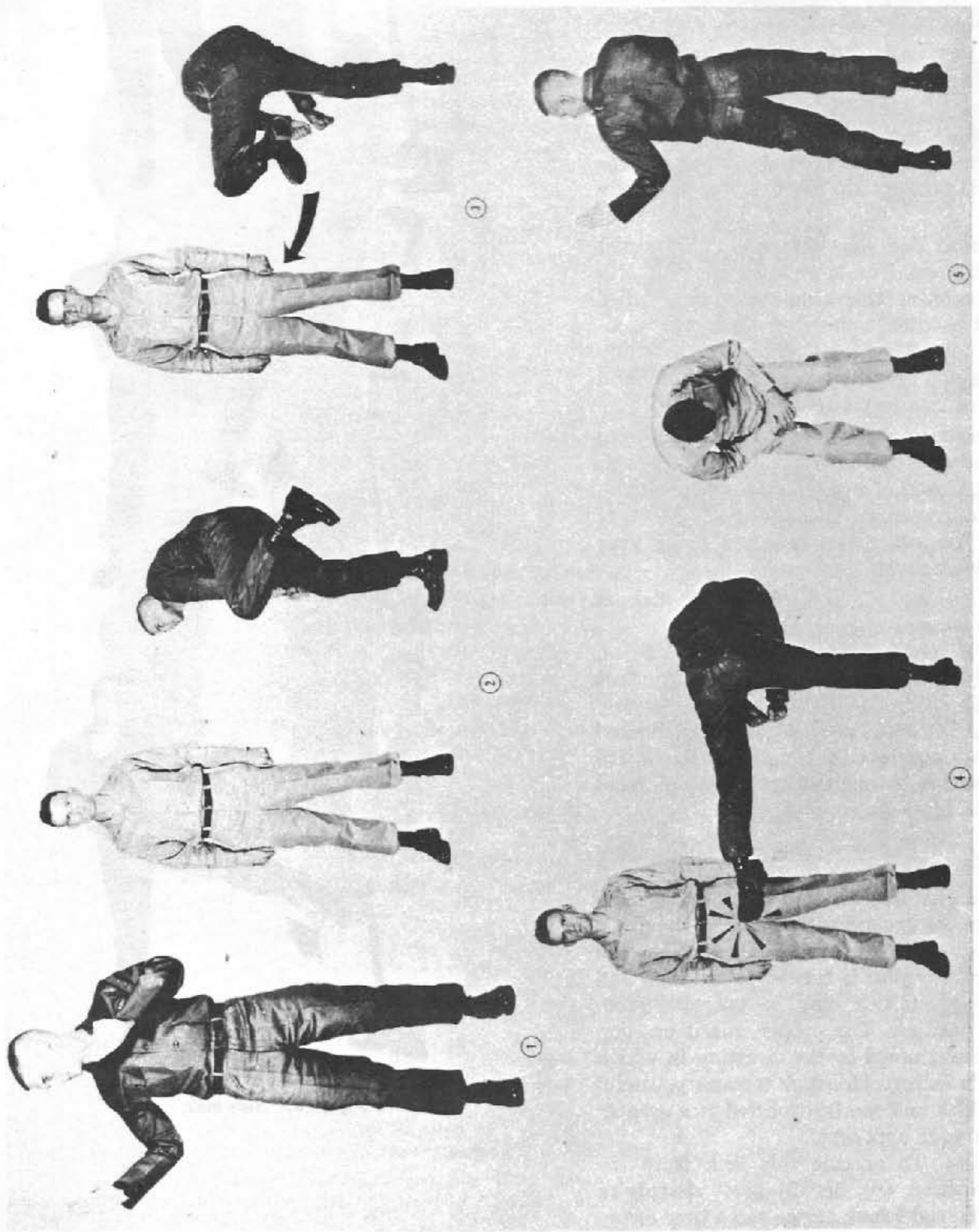

Figure 40. Pivot kick.

ing the lower part of the left leg up (②, fig. 40) until it is in approximately the same horizontal plane as the left knee (③, fig. 40). At the same time extend and straighten the arms, making tight fists with your hands. Place your fists together about 6 to 8 inches in front of the groin. Bend deeply at the waist and flex the right knee. As you pivot on the lead foot, quickly and forcefully extend the lower leg at the knee. The kick is delivered through a horizontal plane into your opponent's groin or midsection (④, fig. 40). The striking surface is the toe of the boot.

c. Followup or Recovery. It is important that the foot be withdrawn quickly to prevent your opponent from catching your foot. After kicking from the right guard position, recover to a left guard position (⑤, fig. 40). During the entire movement the hands are held rigidly in front of the groin region for protection and balance. If you diverted his attack but failed to bring him down, kick again. If he still is facing his original direction this second kick will be to his lower back and kidney region.

d. Instruction and Commands. The pivot kick is taught in three phases:

(1) PIVOT KICK, PHASE ONE, MOVE; on this command pivot 180° on the front foot, lean forward with the hands in front of the body and elevate the knee.

(2) PHASE TWO, MOVE; straighten the knee, and drive the foot to the target area.

(3) PHASE THREE, MOVE; on this command the foot is returned to the ground and the opposite guard position assumed. At normal speed the command is PIVOT KICK, MOVE.

73. Heel Stomp

a. Objective and Use. The purpose of the heel stomp is to dull the opponent's senses by a blow to the head or other vital area. This stomp is used best when the opponent is lying on the ground.

b. Description. To execute the stomp you must be standing over the portion of the body you wish to stomp. Pull the knee up and flex the ankle as much as possible (①, fig. 41). To stomp, straighten out the knee forcefully, striking your opponent with the back edge of the heel of the boot (②, fig. 41). Attempt to drive your heel into the ground to insure that the full force of the kick is delivered to your opponent.

c. Followup or Recovery. Recover quickly either for a second stomp by flexing the knee, or to a guard position if no further action is necessary.

d. Instruction and Commands. The heel stomp is taught in two phases:

(1) HEEL STOMP, PHASE ONE, MOVE;

on this command raise the leg and drive the heel downward forcefully.

(2) PHASE TWO, MOVE; on this command again flex the leg for another stomp; or RIGHT or LEFT) GUARD, MOVE; on this command the designated guard position is assumed. At normal speed the command is HEEL STOMP, MOVE.

74. Football Kick

a. Objective and Use. The object of the football kick is to deliver a powerful kick to a vulnerable area anywhere on the body. It is used best when the opponent is on the ground but not close enough or in the correct position for a heel stomp.

b. Description. To deliver the football kick step close to your opponent, facing him. Plant your non-kicking foot firmly so you can maintain your balance. When you kick with the other foot swing it to the rear and bend the knee. As you swing the kicking foot forward from the hip, straighten your knee and keep the foot close to the ground. The toe is pointed toward your opponent for maximum force (①, fig. 42). Snap the leg forward as if kicking a football (②, fig. 42).

c. Followup or Recovery. Quickly return the kicking foot to the ground and reestablish balance for a second kick or a heel stomp. If no further action is required assume a guard position.

d. Instruction and Commands. The football kick is taught in two phases:

(1) FOOTBALL KICK AND HOLD, MOVE; on this command step onto the non-kicking foot and swing the leg forward driving the kicking foot to the target area.

(2) ON GUARD; on this command bring the kicking leg down to the ground and return to the guard position. At normal speed the command is FOOTBALL KICK, MOVE.

75. Foot Stomp

a. Objective and Use. The objective of the foot stomp is to inflict pain to the opponent's leg or foot. This will slow his attack or divert him. This stomp is used best when the opponent is pressing the attack and you need room or time to gain the initiative.

b. Description. Step back with one foot, turning your side to the opponent (①, fig. 43). As he steps forward, raise the foot closest to him and kick as quickly and forcefully as possible, attempting to strike the opponent on or below the knee with the outside edge of your boot (②, fig. 43).

(1) When you make contact stomp downward on his leg striking your opponent's shin. Allow your foot to continue moving until it strikes his foot (③, fig. 43). This action may break the bones

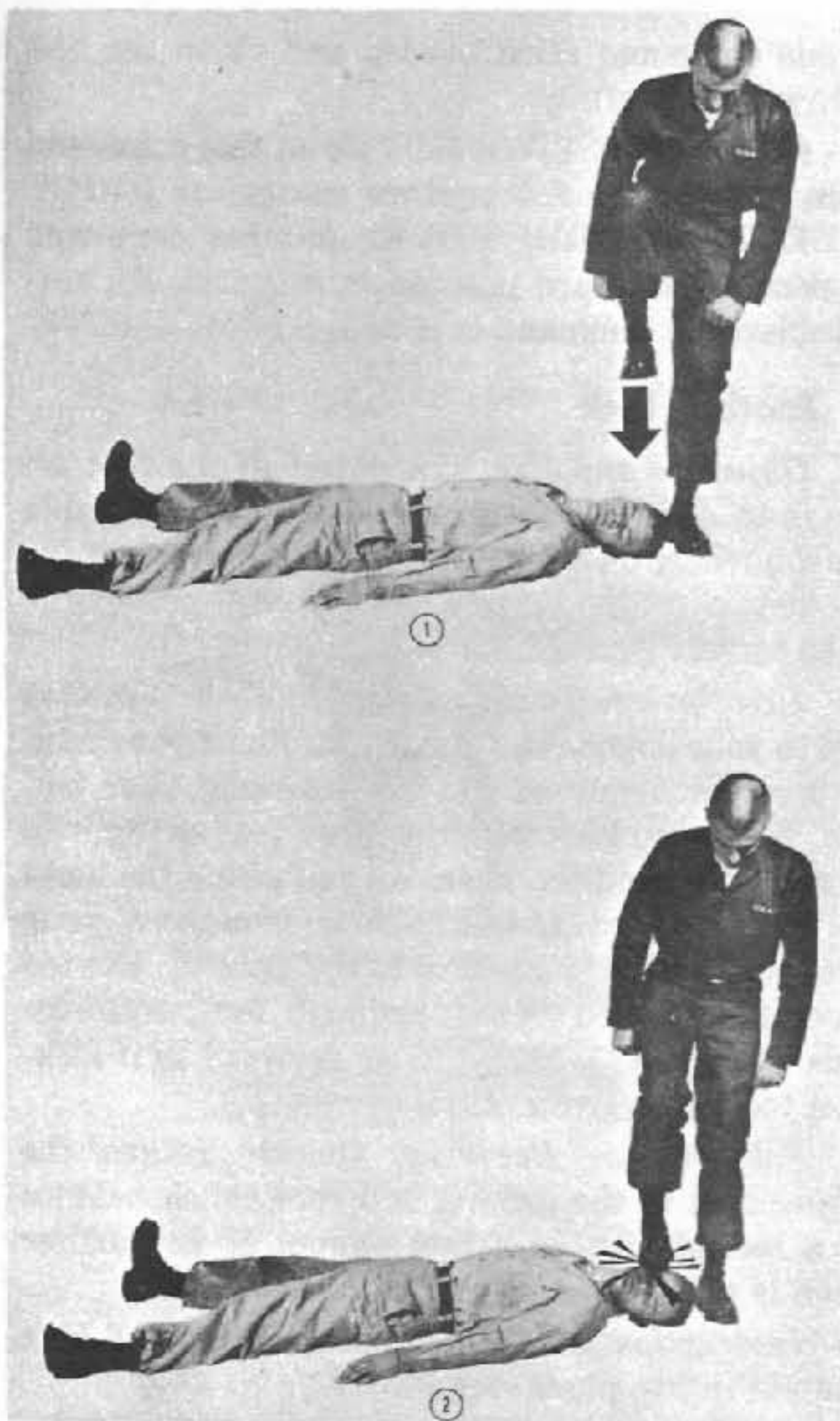

Figure 41. Heel stomp.

in his foot or cause intense pain, thus disabling him.

(2) However, should your foot make contact above the knee, maintain contact and push with your boot. The combination of the blow and the push may disable his knee or numb the muscles of his upper leg, causing him to fall to the ground to render him temporarily immobile.

c. *Followup or Recovery.* Quickly prepare to followup with an appropriate kick or takedown to overcome his resistance, as the opponent, although in pain, will probably still be on his feet.

d. *Instruction and Commands.* The foot stomp is taught in three phases:

(1) **FOOT STOMP, PHASE ONE, MOVE;** on this command execute the movement bringing the foot to rest on or below the opponent's knee, or if the foot strikes above the knee, on his thigh.

(2) **PHASE TWO, MOVE;** on this command slide the foot down your opponent's shin to his foot.

(3) **PHASE THREE, MOVE;** on this command glide back, if a kick is to be used, or recover by moving the foot quickly to the ground if close-in action is desired—such as another stomp, a knee lift, or a takedown. At normal speed the command is **FOOT STOMP, MOVE.**

76. Knee Lift

a. *Objective and Use.* The object of the knee lift is to forcefully drive the knee, from a standing position, into the face or groin of the opponent and disable him. The knee lift is used best when your

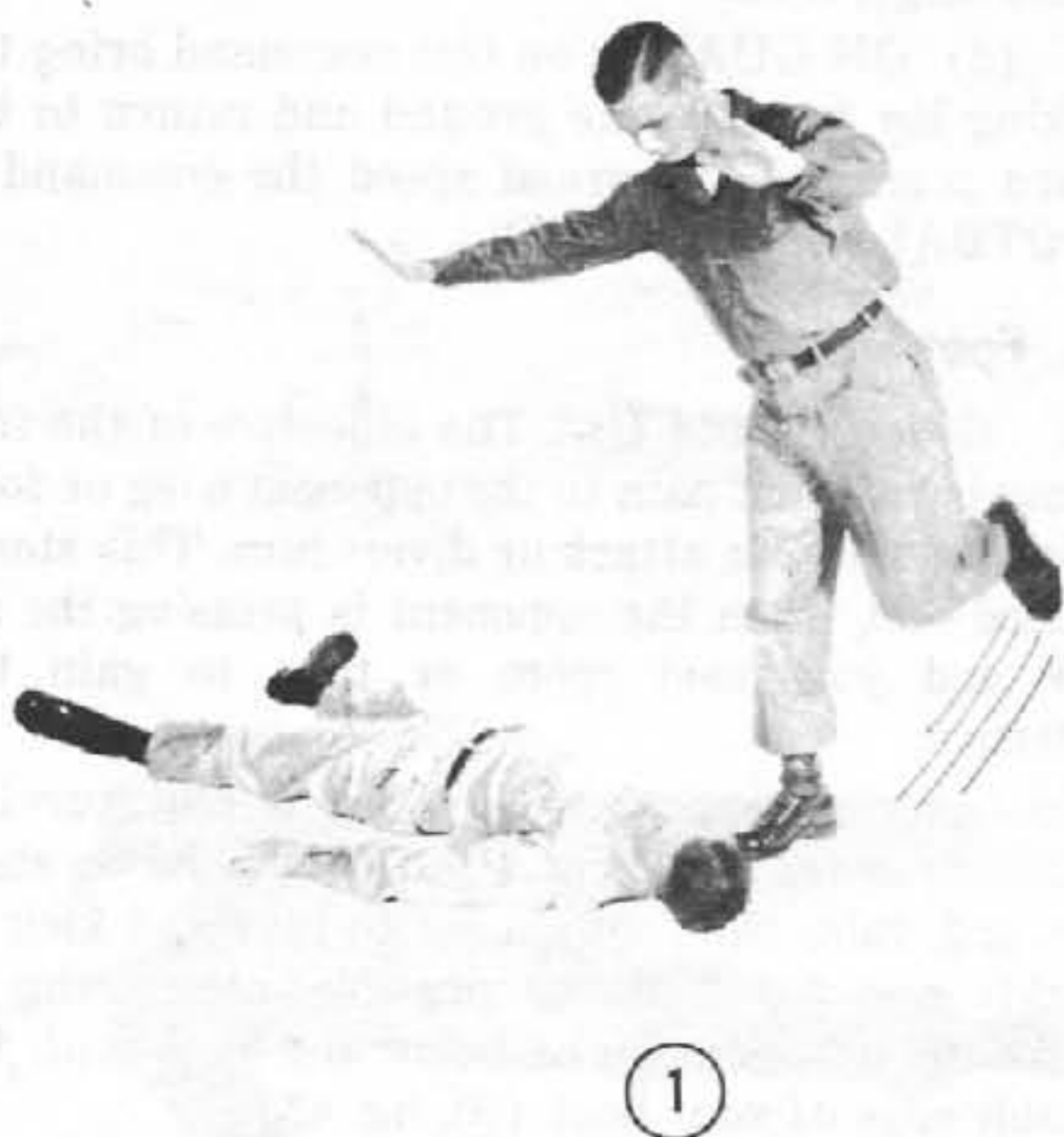

Figure 42. Football kick.

opponent is grappling with you, at close quarters, attempting to wrestle you to the ground.

b. Description. Place your hands on the back of his head to pull it down and hold it in place (①, fig. 44). Bring the knee up fast and hard into his face and at the same time force down with your hands (②, fig. 44). If you find one of your feet between your opponent's feet (③, Fig. 44), raise that leg fast and hard, driving your knee into your opponent's groin (④, fig. 44).

c. Followup or Recovery. A second knee lift can be delivered by quickly returning the foot to the ground and repeating the movement. A takedown can be applied if the opponent retains his balance, or a glide to the rear can be performed to gain distance for a kick.

d. Instruction and Commands. The knee lift is taught in three phases:

(1) **KNEE LIFT, PHASE ONE, MOVE;** on this command pull the opponent's head downward.

(2) **PHASE TWO, MOVE;** on this command step in close and drive the knee to the target area(s) and hold.

(3) **ON GUARD;** on this command return the foot quickly to the ground and assume a guard position. At normal speed the command is **KNEE LIFT (to head or groin) MOVE.**

77. Takedowns

If a kick fails or is inappropriate due to the opponent closing in on you it may be more appropriate to use a takedown to get him on the ground. Takedowns usually are applied from the front although should you find yourself in rear of your opponent, there are rear takedowns which can be applied. Takedowns are simple to apply and powerful leverage is used which results in a great amount of force

being applied to the opponent. This characteristic makes takedowns highly effective and affords a rapid means of overcoming your opponent.

78. Cross-Hock Takedown

a. Objective and Use. The object of the cross-hock takedown is to approach the opponent from the front, break his balance, and take him down. This takedown is best used when your opponent is moving in or is facing you in an upright position.

b. Description.

(1) Start the cross-hock takedown from the guard position (facing your opponent). Step in with your left foot placing it slightly outside of your opponent's right foot. Simultaneously strike your opponent vigorously on both shoulders with the heels of your hands and grab his clothing. This blow knocks him off balance to the rear (①, fig. 45).

(2) Move forward shifting your weight to your left foot, maintaining your hold on his shoulders. As you shift your weight, swing your right leg forward in an arc between your left leg and your opponent's right leg until it reaches a point parallel with the ground (②, fig. 45).

(3) Swing your raised right leg downward, forcefully striking your opponent's right leg and making calf-to-calf contact. As you kick his right leg, drive his shoulders into the ground (③, fig. 45).

c. Followup or Recovery. As your opponent goes down follow with a heel stomp or football kick to a vital area.

d. Instruction and Commands. The cross-hock takedown is taught in three phases:

(1) **CROSS-HOCK TAKEDOWN, PHASE**



Figure 48. Foot Stomp.



①



②



③



④

Figure 44. Knee lift to head or groin.

ONE, MOVE; on this command step in, strike your opponent's shoulder, grasp his clothing, and move him off balance.

(2) PHASE TWO, MOVE; on command move forward continuing to hold clothing, shift weight, and swing your leg upward and hold.

(3) PHASE THREE, MOVE; on this command swing raised leg downward against opponent's leg and drive his shoulders to the ground. At normal speed the command is CROSS-HOCK TAKEDOWN, MOVE.

79. Head Twist Takedown

a. Objective and Use. The object of the head twist takedown is to break close contact and twist the opponent away and to the ground. This takedown is used best when the opponent is very close attempting to grapple with or grasp you.

b. Description. When your opponent seizes you (①, fig. 46), immediately grasp your opponent's jaw between your thumb and fingers. Grasp the back of his head with your other hand (②, fig. 46), and twist sharply to either the right or left to break his hold. Maintain your hold and force him downward. As he falls release your hold if you are losing your balance.

c. Followup or Recovery. Generally, your opponent is at your feet and a kick or stomp can be delivered readily to a vulnerable area.

d. Instruction and Commands. The head twist takedown is taught in two phases:

(1) HEAD TWIST TAKEDOWN, PHASE ONE, MOVE; on this command, grasp opponent's head and hold.

(2) PHASE TWO, MOVE; on this command apply the twist and take opponent down. At normal

speed the command is HEAD TWIST TAKE-DOWN, MOVE.

80. Rear Strangle Takedown

a. Objective and Use. The object of the rear strangle takedown is to destroy your opponent's balance and take him to the ground by application of a strangle hold. This strangle hold is used best in a surprise attack from the rear, or during a struggle in which you suddenly find yourself behind your opponent when both of you are standing.

b. Description.

(1) Start from the guard position, standing directly behind and facing the same direction as your opponent. Step in with your right foot placing it directly behind your opponent. Simultaneously thrust your right arm, palm down, around your opponent's neck, striking hard on his Adam's apple with the large bone of your forearm. With your left fist strike your opponent a vigorous blow in the kidney region to break his balance to the rear (①, fig. 47).

(2) Maintaining a firm hold with the right arm and keeping your opponent off balance with your left fist and your head along the left side of his head, walk backwards pulling him to the ground. Now you should be lying on the ground, stomach down, with your opponent on his back with his body in direct line with yours. Your legs should be spread apart to prevent your opponent from rolling you over (②, fig. 47).

(3) Pull your right arm tight into your opponent's throat and place your chin over the back of your right hand, locking your opponent's head into the hold. By pulling in with the right arm and rolling your right shoulder up behind your oppo-



Figure 45. Cross-hock takedown.



Figure 46. Head twist takedown.

nent's head, you can apply enough pressure to strangle him or break his neck.

(4) In combat you would lunge at your opponent from his rear, applying the takedown hold described in figure 47. This lunge movement IS NOT to be used in training since the opponent's neck can be broken upon impact from the fall (fig. 48).

c. Followup or Recovery. If you maintain your hold for several minutes your opponent will be unconscious and no further followup is needed.

d. Instruction and Commands. The rear strangle takedown is taught in three phases:

(1) REAR STRANGLE TAKEDOWN, PHASE ONE, MOVE; on this command apply the hold loosely.

(2) PHASE TWO, MOVE; on this command push opponent off balance with the left fist and

walk backward slowly pulling him to the ground and at the same time go down with him to lessen the pressure on his neck.

(3) PHASE THREE, MOVE; on this command gradually pull in and roll the shoulder up behind your opponent's head to demonstrate the pressure that can be applied. In training the normal speed is not attempted. To practice the takedown without pause for phase commands, the command is REAR STRANGLE TAKEDOWN, MOVE.

81. Rear Takedown

a. Objective and Use. The objective of the rear takedown is to knock your opponent off balance and drive him to the ground in one continuous motion. The best use of this takedown is under the same

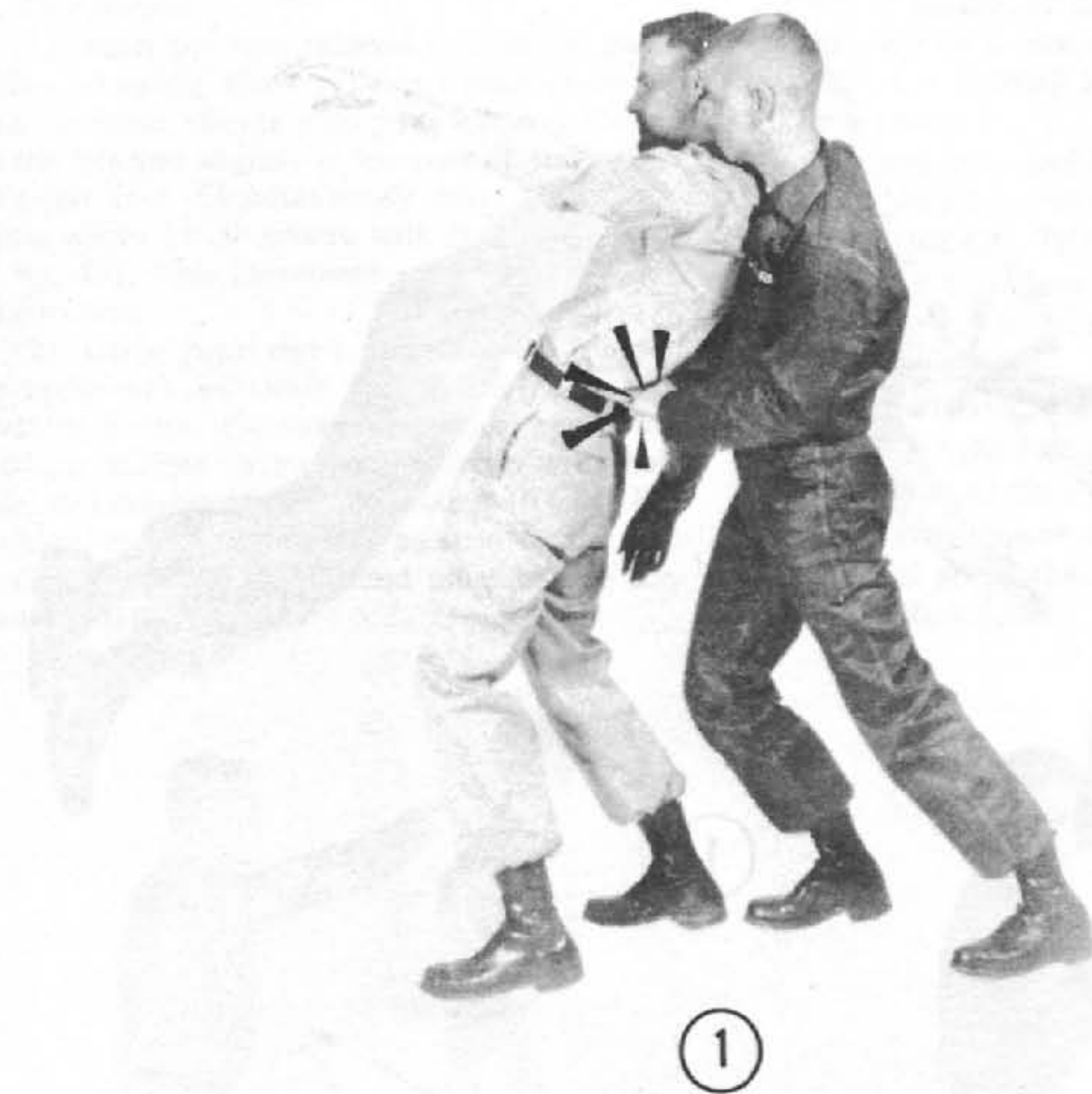

Figure 47. Rear strangle takedown (training).

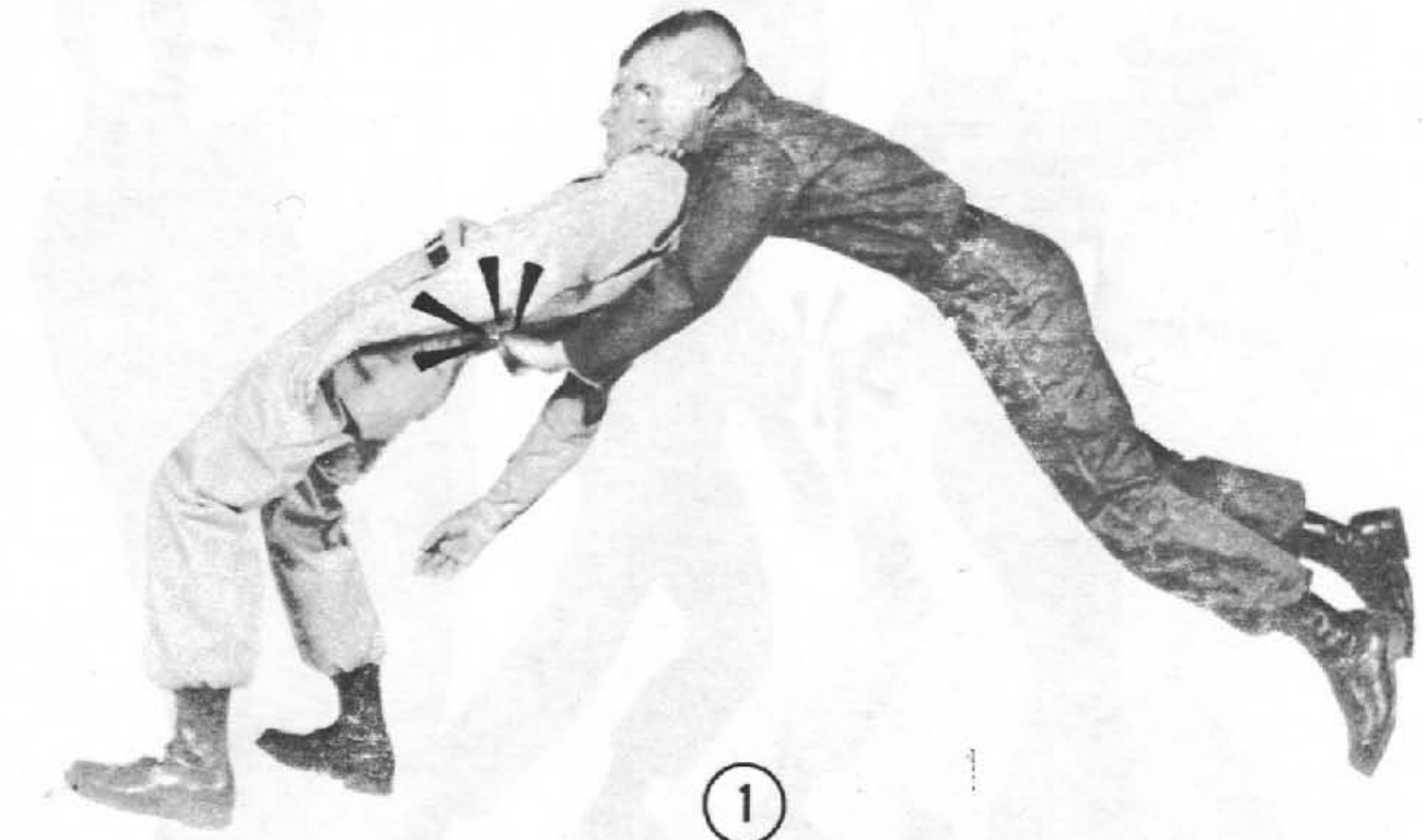

Figure 48. Rear strangle takedown (combat).

circumstances as previously indicated for the rear strangle takedown (para 80).

b. Description.

(1) Start the rear takedown from the guard position, standing directly behind your opponent, facing his back. Step in with your left foot placing it to the left and slightly to the rear of your opponent's left foot. Simultaneously raise your hands directly above his shoulders with the palms down (①, fig. 49). This movement is executed swiftly, in one motion.

(2) Drive your right foot into the rear of your opponent's left knee and at the same time forcefully strike downward on your opponent's shoulders, pulling to your right rear with both hands, and driving him to the ground (②, fig. 49). Knocking your opponent off balance to the rear and driving him to the ground must be one continuous motion.

c. Followup or Recovery. Your opponent is down in either a sitting or prone position with his back to you if sitting, or his head close to your feet if prone. Deliver a kick to the kidney region if he is sitting or a football kick or a stomp to his head if he is prone.

d. Instruction and Commands. The rear takedown is taught in two phases:

(1) REAR TAKEDOWN, PHASE ONE, MOVE; on this command step to your opponent's left as directed and raise your hands into position above his shoulders.

(2) PHASE TWO, MOVE; on this command drive your right foot into the rear of his left knee and at the same time strike down on his shoulders and pull your opponent to the right rear and down. At normal speed the command is REAR TAKE-DOWN, MOVE.



Figure 49. Rear takedown.

Section IV. COUNTERS

82. General

a. If your opponent seizes you or attempts to seize you, you must break his hold before or immediately after he completes it. Bite, kick, or strike him at vulnerable points to help loosen or break the hold before he can apply pressure. By escaping

from your opponent's grasp immediately, you can take the offensive and attack him.

b. There are methods which you can apply to break the opponent's hold should he succeed in grasping you. These techniques are known as counters.

83. Check Blows

A check blow is a blow used to counter your opponent's action if he seizes you or attempts to seize you. It is a vigorous blow delivered with the hand or elbow to one of your opponent's vulnerable points. Check blows are used as part of counters.

84. Finger Jab

a. Objective and Use. The object is to interfere with your opponent's vision or breathing. The finger jab to the eyes or throat is used to disable an opponent when he attempts to seize you from the front or when he is too close to kick.

b. Description. In forming the hand for the finger jab, the fingers are extended and joined, thumb along the index finger. The wrist is locked. The jab is a sharp movement made from the elbow and shoulder and directed at the eyes or throat of your opponent (fig. 50).

c. Followup or Recovery. If time permits and distance is available recover and jab again. If your opponent closes or grasps you, a knee lift (fig. 44) or head twist takedown (fig. 46) is appropriate.

d. Instruction and Commands. The finger jab is taught in two phases:

(1) FINGER JAB (TO EYES OR THROAT AND HOLD), MOVE; on this command jab at target area and hold.



Figure 50. Finger jab to the eyes.

(2) ON GUARD; on this command recover to the guard position. At normal speed the command is FINGER JAB, MOVE.

85. Reaction to Ground Contact

a. First Action. If you are knocked or thrown to the ground, or you trip and fall, counter by immediately getting to your feet. Use any possible method but move fast as this is the best and safest course of action. If falling backward, the best method is to roll over and regain a position on your feet.

b. Alternate Action. If you are on the ground and unable to get to your feet before the opponent closes and attacks, then you must counter by fighting from that position until you get an opportunity to regain your feet. It must be understood that this action is least desirable and in most situations a man on the ground is no match for a man on his feet.

86. Backward Roll

a. Objective and Use. The objective of a backward roll is to gain distance from the opponent and regain a position on your feet. A roll is used best if you are falling backward and have sufficient momentum to complete the roll.

b. Description. As you fall, assume a sitting posture and as the buttocks contact the ground, draw the knees to your chest and raise the elbows to the front with the palms of the hands upward, fingers to the rear. As you roll into the back and neck, allow the neck to bend. As the legs come over your head the weight shifts to your shoulder and back of your head. By this time the hands will have contacted the ground followed by the soles of the feet. The legs remain in a flex position throughout the roll (fig. 51).

c. Followup or Recovery. When the feet touch the ground stand up and assume a guard position preparatory to resumption of your attack.

d. Instruction and Commands. The backward roll is taught in one movement as momentum must be present to complete the roll properly. The command at normal speed is BACKWARD ROLL, MOVE.

87. Counter to Rear Hold, Arms Pinned

a. Objective and Use. The objective of this counter is to break the rear hold and in doing so take the opponent down. This counter is used when your opponent is close behind you and has your arms pinned.

b. Description. If you are grasped from the rear with a body hold in which your arms are pinned (①, fig. 52), immediately flex the knees and, at the same time, thrust your buttocks to the



Figure 51. Backward roll.

rear and your arms straight forward from your shoulders (②, fig. 52). Shift your hips to the left and rotate the upper part of your body to the right. Keeping the right elbow locked, swing the back of your fist into your opponent's groin (③, fig. 52). This is a vigorous blow delivered from the shoulder. As you swing, look at your target. The check blow may also be delivered by driving your elbow into your opponent's stomach.

c. Followup or Recovery. The blow should cause your opponent to lose his grip on you and he should be somewhat stunned or injured. At the conclusion of the check blow quickly turn, face your opponent, and kick with an appropriate kick depending upon whether he went down as a result of the blow, or remained on his feet.

d. Instruction and Commands. This counter is taught in two phases:

(1) COUNTER TO REAR HOLD, OVER ARMS PINNED, PHASE ONE, MOVE; on this command flex knees, thrust buttocks to the rear, and straighten arms.

(2) PHASE TWO, MOVE; at this command shift your hips, rotate body, and swing your fist into the opponent's groin. At normal speed the command is COUNTER TO REAR HOLD, ARMS PINNED, MOVE.

88. Counter to Rear Hold, Arms Free

a. Objective and Use. The objective of this counter is to break the rear hold and at the same time take the opponent down. This counter is used when your opponent is close behind you, grasping you around the trunk with your arms free.

b. Description. If your opponent takes a rear body hold leaving your arms free (①, fig. 53), immediately grasp one of your opponent's wrists with your opposite hand (②, fig. 53). With a vigorous movement, smash your free elbow to your

opponent's head while pulling your opponent into the blow (③, fig. 53). The direction of the blow follows the line of your opponent's arm, which you are holding. This movement may be executed to the right or left.

c. Followup or Recovery. This vigorous blow should cause your opponent to lose his grip and be knocked to the ground. The blow will stun or injure him to the extent that you will have time to quickly turn, face your opponent, and deliver an appropriate kick.

d. Instruction and Commands. This counter is taught in two phases:

(1) COUNTER TO REAR HOLD, ARMS FREE, PHASE ONE, MOVE; on this command grasp one of his wrists and pull downward.

(2) PHASE TWO, MOVE; on this command flex the elbow and smash to the opponent's head. At normal speed the command is COUNTER TO REAR HOLD, ARMS FREE, MOVE.

89. Counter to Rear Strangle Hold

a. Objective and Use. The objective of this counter is to break the strangle hold to permit resumption of your attack. This counter is used when the enemy applies a strangle from the rear encircling his arm around your neck.

b. Description. If your opponent attempts to apply a rear strangle hold (①, fig. 54), immediately grasp his arm with your opposite hand and bend deeply at the knees, twisting your body in the opposite direction of your free arm (②, fig. 54). Vigorously rotate your upper body and drive your free elbow into his armpit (③, fig. 54). You always will deliver this blow towards the arm encircling your neck.

c. Followup or Recovery. The elbow smash to the ribs or armpit will cause your opponent to lose



①



②



③

Figure 52. Counter to rear hold, arms pinned.



Figure 58. Counter to rear hold, arms free.

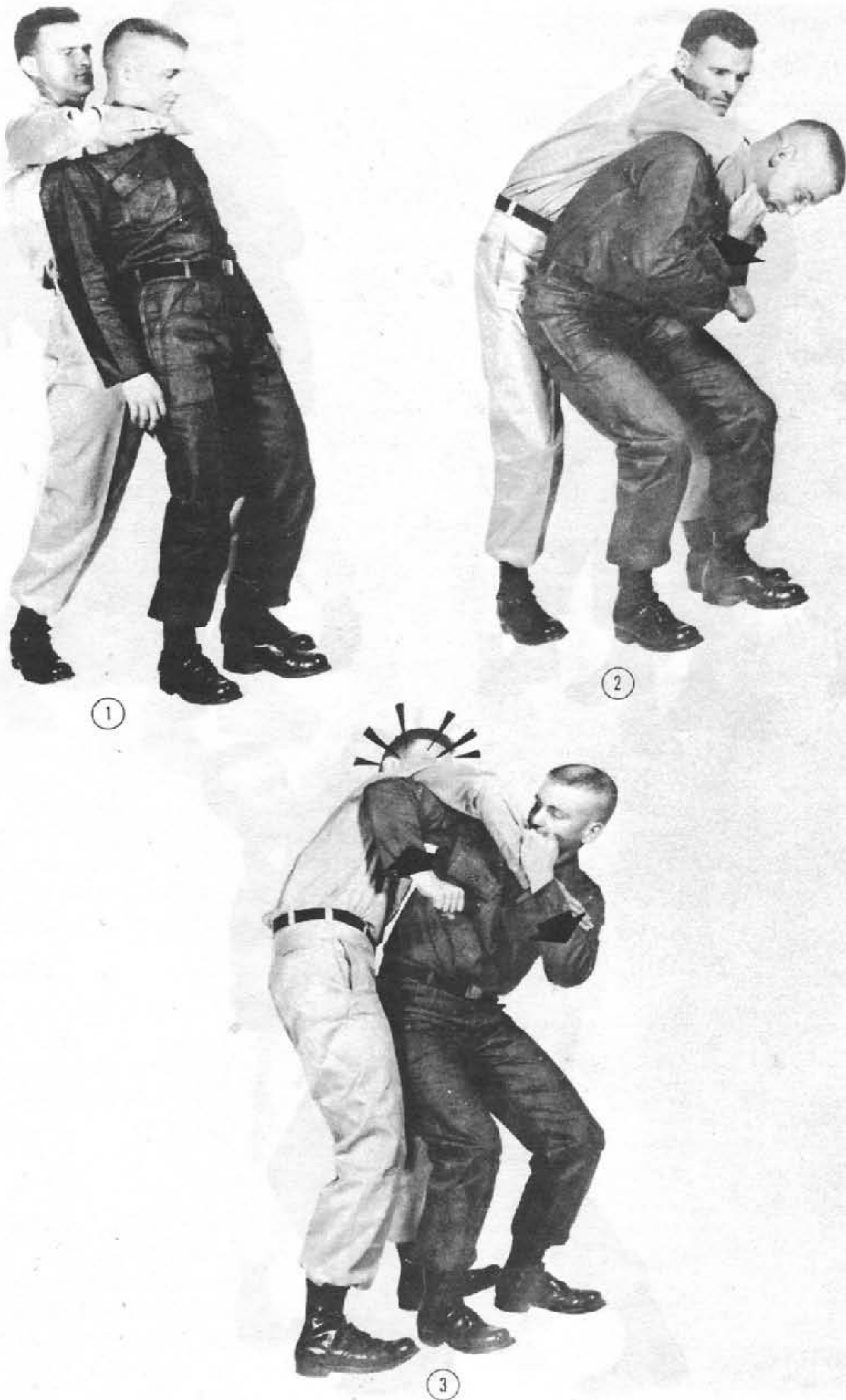

Figure 54. Counter to rear strangle hold.

his grip and provide the time needed to quickly turn and deliver an effective kick or stomp.

d. Instruction and Commands. This counter is taught in two phases:

(1) COUNTER TO REAR STRANGLE HOLD, PHASE ONE, MOVE; on this command grasp your opponent's arm, bend at the knees and twist the body.

(2) PHASE TWO, MOVE; on this command rotate your body and drive the free elbow into your opponent's armpit. At normal speed the command is COUNTER TO REAR STRANGLE HOLD, MOVE.

90. Counter to Front Body Hold Arms Pinned

a. Objective and Use. The objective of this counter is to break the hold in order to counterattack. This counter is used when the opponent has applied a close hold from the front and your arms are pinned.

b. Description. If your opponent seizes you from the front and pins your arms, immediately thrust

your buttocks to the rear and execute a check blow to his groin (fig. 55).

c. Followup or Recovery. The opponent is forced to release his hold. At that time immediately follow up with a knee lift, or glide away and kick.

d. Instruction and Commands. The counter to a front hold, arms pinned, is taught in two phases:

(1) COUNTER TO FRONT BODY HOLD, ARMS PINNED, PHASE ONE, MOVE; on this command thrust your buttocks to the rear.

(2) PHASE TWO, MOVE; on this command execute a check blow to your opponent's groin. At normal speed the command is COUNTER TO FRONT BODY HOLD, ARMS PINNED, MOVE.

91. Counter to Front Hold Arms Free

Two movements included in section III can be used when the arms are free and these actions are very effective when used as counters.

a. Knee Lift. The knee lift (para 76) to the groin is a fast and powerful counter.

b. Head Twist Takedown. The head twist take-



①



②

Figure 55. Counter to front body hold, arms pinned.

down (para 79) is simple to apply and very effective in breaking a front hold when the arms are free.

92. Counters to Kicks

a. Objective and Use. The objective is to deflect, block, or catch your opponent's foot as he kicks. The counters to kicks are best used when there is not time or room to glide out of range of your opponent's kick.

b. Description.

(1) To deflect a side or pivot kick by your opponent, swing your leading arm downward and back, striking his lower leg a sharp blow with the back of your fist or forearm (fig. 56). When executing this counter, form the hand into a fist to protect your fingers.

(2) If your opponent attempts to kick you



Figure 56. Counter to a side or pivot kick.



Figure 57. Counter to football kick.

with a conventional kick, raise your nearest foot and meet this kick with the instep of your boot across his shin (fig. 57).

(3) As another means of blocking your opponent's kick, block with your forearm and sweep upward with your other arm, catching his leg. The blocking arm is bent at the elbow and is held rigidly at chest height to protect your head from his kick (①, fig. 58).

c. Followup or Recovery. As a followup action to (1) and (2) above immediately follow through with a side kick to his groin. When catching the kick as in (3) above immediately execute a pivot kick to his groin (②, fig. 58).

d. Instruction and Commands. These counters to kicks are taught in one phase as follows:

(1) ARM SWEEP COUNTER TO KICK, MOVE; on this command the opponent kicks and you counter with an arm sweep movement.

(2) FOOT BLOCK COUNTER TO KICK, MOVE; on this command the opponent kicks with a football kick and you block with your foot over his instep.

(3) ARM CATCH COUNTER TO KICK, MOVE; on this command catch his kick with both arms.



Figure 58. Arm catch counter to kicks.

Section V. BAYONET PARRIES AND DEFENSE AGAINST KNIFE ATTACK

93. Parries to the High Thrust and Low Thrust

a. A parry is used only when no other means of defense is possible. If your opponent initiates his attack from the high port position, you must evade his initial movements by the use of the glide. As soon as he commits himself to a thrusting movement immediately execute one of the movements described below.

b. The objective of a parry is to deflect the thrust long enough to followup and counterattack.

(1) High parry.

(a) *Use.* The high parry is used when your opponent thrusts at the upper portion of your body.

(b) *Description.* To execute the high parry,

stand facing your opponent with your feet a comfortable distance apart (①, fig. 59). As your opponent thrusts, pivot on the ball of the right foot, bringing the left foot back on line with the right. Simultaneously parry the weapon, using the inside portion of the right forearm. Keep the palm forward with the fingers extended and joined (②, fig. 59). If the weapon is carried on the left side of your opponent's body, the actions would be reversed.

(c) *Followup or recovery.* After you have executed a high parry, immediately raise the elbow of the arm with which you parried the weapon, and



Figure 59. High bayonet parry.

deliver a smashing blow with the elbow to his face (③, fig. 59).

(d) *Instruction and commands.* The high parry is taught in three phases:

1. HIGH THRUST AND PARRY, PHASE ONE, MOVE; on this command you pivot and simultaneously parry the weapon.

2. PHASE TWO, MOVE; on this command deliver an elbow smash to your opponent's head. At normal speed the command is HIGH THRUST AND PARRY, MOVE.

(2) *Low parry.*

(a) *Use.* The low parry is used when your opponent thrusts at the lower part of your body.

(b) *Description.* To parry a thrust at the lower portion of the body (①, fig. 60), shift your body out of the way in the same manner as in the high parry. Parry the weapon with arm fully extended, palm forward, fingers pointing downward (②, fig. 60).

(c) *Followup or recovery.* After executing a low parry, immediately grasp the forward portion of the weapon with your left hand, pulling the weapon tightly against your hip, (③, fig. 60), and execute a pivot kick to your opponent's groin or a kick to his knee (④, ⑤, fig. 60). When grasping the weapon, it is important that you immediately pull and hold the weapon tightly against your hip. This makes it difficult for your opponent to pull the weapon away from you as you deliver the kick.

(d) *Instruction and commands.* The low bayonet parry is taught in three phases:

1. LOW THRUST AND PARRY, PHASE ONE, MOVE; on this command pivot and straighten the parry arm at your side, parrying the weapon.

2. PHASE TWO, MOVE; grasp the rifle in the nonparry hand.

3. PHASE THREE, MOVE; on this command deliver a kick to your opponent's groin or knee. At normal speed the command is LOW THRUST AND PARRY, MOVE.

94. Defense Against Knife Attack

a. *Avoid Close Contact.* The first line of defense against an opponent armed with a knife is to avoid close contact. It is dangerous to attempt to disarm your opponent by hand, as such a technique is an advanced skill (chap 7).

b. *Disarm Your Opponent.* Any opponent, regardless of his skill with a knife, is dangerous. For this reason you must disarm him with the safest and most effective method. The following methods are recommended:

(1) Use an object to aid your attack such as a heavy stick or similar available weapon. Attempt to knock or kick the weapon from your opponent's hand (①, fig. 61, or ②, fig. 61).

(2) Kick or hit your opponent in a vulnerable spot which will cause him to cease his attack (③, fig. 61).

(3) Use a piece of your equipment as a weapon such as your helmet. Hold the chin strap and swing it toward the knife to knock it out of your opponent's hand. You can also use a web belt with canteen to swing as a weapon (④, fig. 61). A field jacket or poncho can be used to cover or muffle the force of a knife blow (⑤, fig. 61).

(4) You can scoop up sand or dirt from the ground and throw it into your opponent's eyes. Use an underhand motion to scoop and throw in the same motion. This action will temporarily blind him and enable you to counterattack (⑥, fig. 61). Any of the above actions will gain time for you to seize the initiative and attack with a weapon, kick, or other appropriate means of attack.

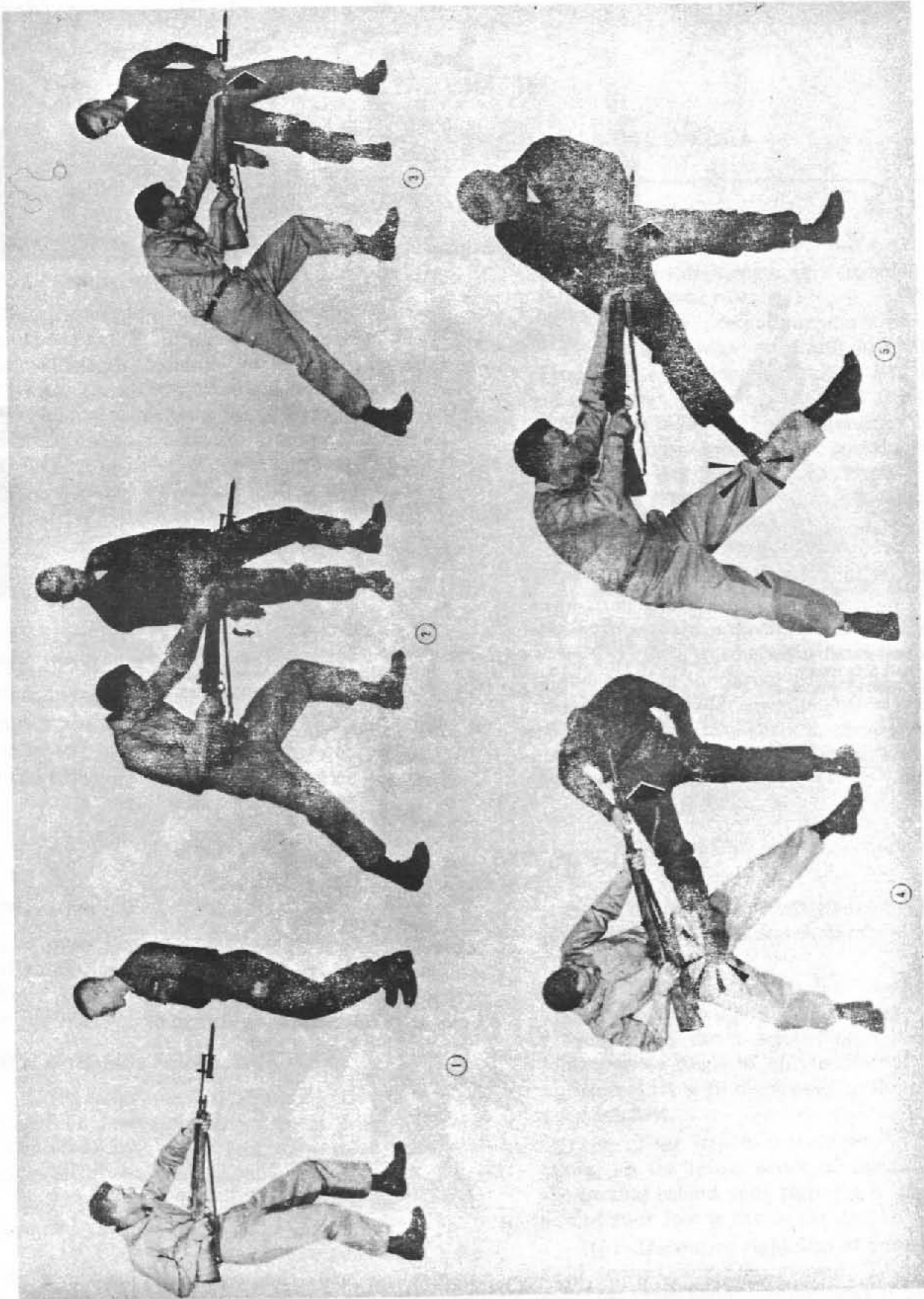
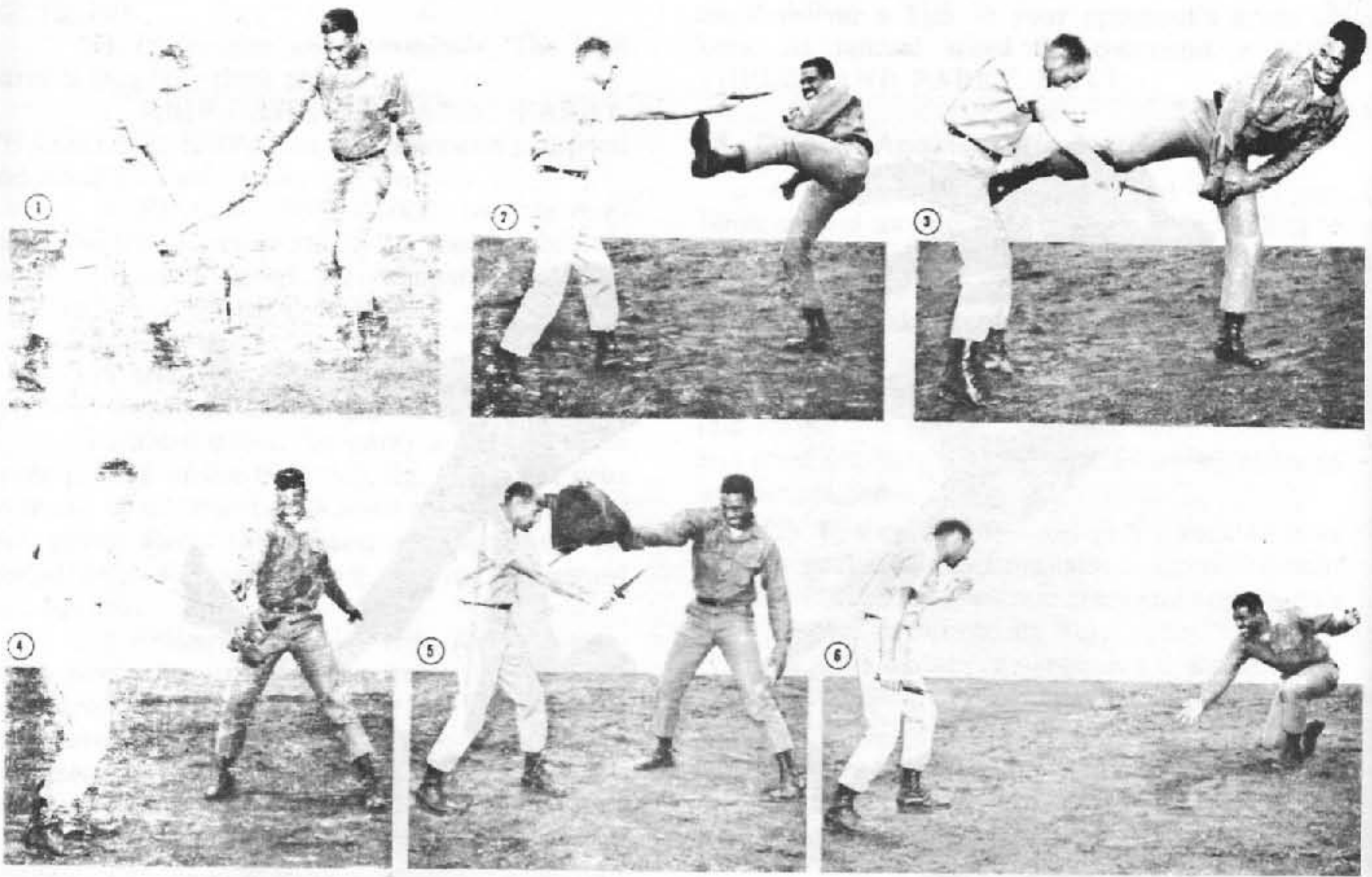

Figure 60. Low bayonet parry.



1. Use a heavy stick to hit knife
2. Kick the knife away
3. Hit a vulnerable spot
4. Swing a piece of equipment—pistol belt around opponent's wrist
5. Cover knife with field jacket or poncho
6. Throw sand or dirt in opponent's eyes

Figure 61. Basic counters to a knife attack.

CHAPTER 7

ADVANCED HAND-TO-HAND COMBAT

Section I. INTRODUCTION

95. Purpose and Scope

This chapter outlines the more advanced skills of hand-to-hand fighting. During the advanced phase of training, the hand-to-hand fighter is taught basic throws, takedowns, and the counters to these throws and takedowns. In addition, he learns various methods he may use to counter an opponent armed with rifle and bayonet, and he is taught knife fighting techniques which he can use when armed with only a knife. Application of the advanced system of hand-to-hand combat is designed for the soldier who has received previous hand-to-hand combat instruction.

96. Training

Due to the nature of the advanced material outlined in this chapter more time should be devoted to this training than was devoted to basic skills in order to perform these procedures correctly. When instructing in the advanced phase of hand-to-hand

training, the instructor must remember to use the following general rules:

a. All safety precautions must be adhered to when training with the knife and rifle-bayonet. During this training, instructors will insure that all such weapons remain sheathed at all times.

b. In the advanced phase, accuracy in performing the throws is the most important factor. Once the fighter has become familiar with the movements, he should concentrate on increasing his speed while maintaining his accuracy.

97. Front Guard Position

The front guard is the basic position from which most movements outlined in this chapter will begin (fig. 38). This guard will afford you a well-balanced position in closing with your opponent and overcoming him. This position often is used in conjunction with a takedown, application of a throw, or disarming an opponent armed with a rifle and bayonet, or a knife.

Section II. FALL POSITIONS

98. General

You must learn various fall positions before you attempt the throws that are taught in hand-to-hand combat. Constant practice in these positions will enable you to be thrown without being injured.

99. Right Side Fall Position

a. *Objective and Use.* The objective is to learn to fall on your right side without injury. The fall position is used when you are thrown with your right side toward the ground.

b. *Description.* The points to check for the right side fall position (fig. 62) are as follows:

(1) Your chin is tucked into your chest, keeping your head off the ground. Your neck remains tense to prevent your head from striking the ground and being injured.

(2) Your left arm is held across the face. This

prevents injury to your left elbow and offers some protection to the head and throat from the blows of your opponent.

(3) Your right arm is the "beating" arm and takes up additional shock. It is extended along the ground, palm down with fingers extended and joined, at an angle of 45° to the body. This arm makes contact with the ground at the same time as your left foot.

(4) Your left foot is driven to the ground, taking up the initial shock of the fall. It strikes the ground behind your right leg at the knee. The sole of your foot is flat on the ground.

(5) The entire right side of your body makes solid contact with the ground. To prevent your right leg from being injured relax it by bending it slightly at the knee.

c. *Followup or Recovery.* If thrown, immedi-

ately get to your feet. As a second priority defend yourself from a ground fighting position (para 58b) until you can regain your feet.

d. Instruction and Commands. The right side fall position is taught by following the procedure as specified in *b* above. The phases are:

(1) **RIGHT SIDE FALL POSITION, PHASE ONE, MOVE;** at this command take up a full squat, reach to the rear with your left hand and place it on the ground, bring your right arm across your chest, and raise your right leg so that it is parallel to the ground or slightly higher.

(2) **PHASE TWO, MOVE;** at this time roll your body to the right and contact the ground. At normal speed the command is **RIGHT SIDE FALL POSITION, MOVE.**

100. Left Side Fall Position

a. Objective and Use. The objective is to learn

101. Practicing the Right Side Fall

a. Starting Position (fig. 64). First take up a full squat, reach to the rear with your left hand and place it on the ground, bring your right arm across your chest, and raise your right leg so that it is parallel with the ground or slightly higher.

b. Execution. Bend the left arm and left leg slightly, canting your entire body to the left. Watch the ground over your right shoulder. Simultaneously swing the right arm forcefully to the right, and thrust your body into the air in a rolling motion to the right by extending your left arm and left leg vigorously. Your right hand and left foot strike the ground first, taking the initial shock of the fall. Keep your chin tucked tightly into your chest to prevent your head from striking the



Figure 62. Right side fall position.

to fall on the left side without injury. This fall position is used when you are thrown with your left side toward the ground.

b. Description. The points to check for the left side fall position are the same as those for the right side fall position (para 99b). Simply substitute the words "left" for "right" and "right" for "left" (fig. 63).

c. Followup or Recovery. Your actions are the same as in the right side fall position (para 99c).

d. Instruction and Commands. The left side fall position is taught by substituting the words "left" for "right" and "right" for "left" in the same procedure as used to teach the right side fall position (para 99d)

ground. The completed fall should be the same as in figure 62.

c. Instruction. After the men learn fall positions to the right and left, practice of both can occur by moving from one fall position to the other. To assume the left side fall position from the right side fall position execute the movement as follows: on the preparatory command **LEFT SIDE FALL POSITION** raise both legs high into the air, support the body weight on the shoulders and right arm. On the command of execution, **MOVE**, roll over to a left side fall position. The same movement can be executed when starting from a left side fall position by reversing the procedure. To practice

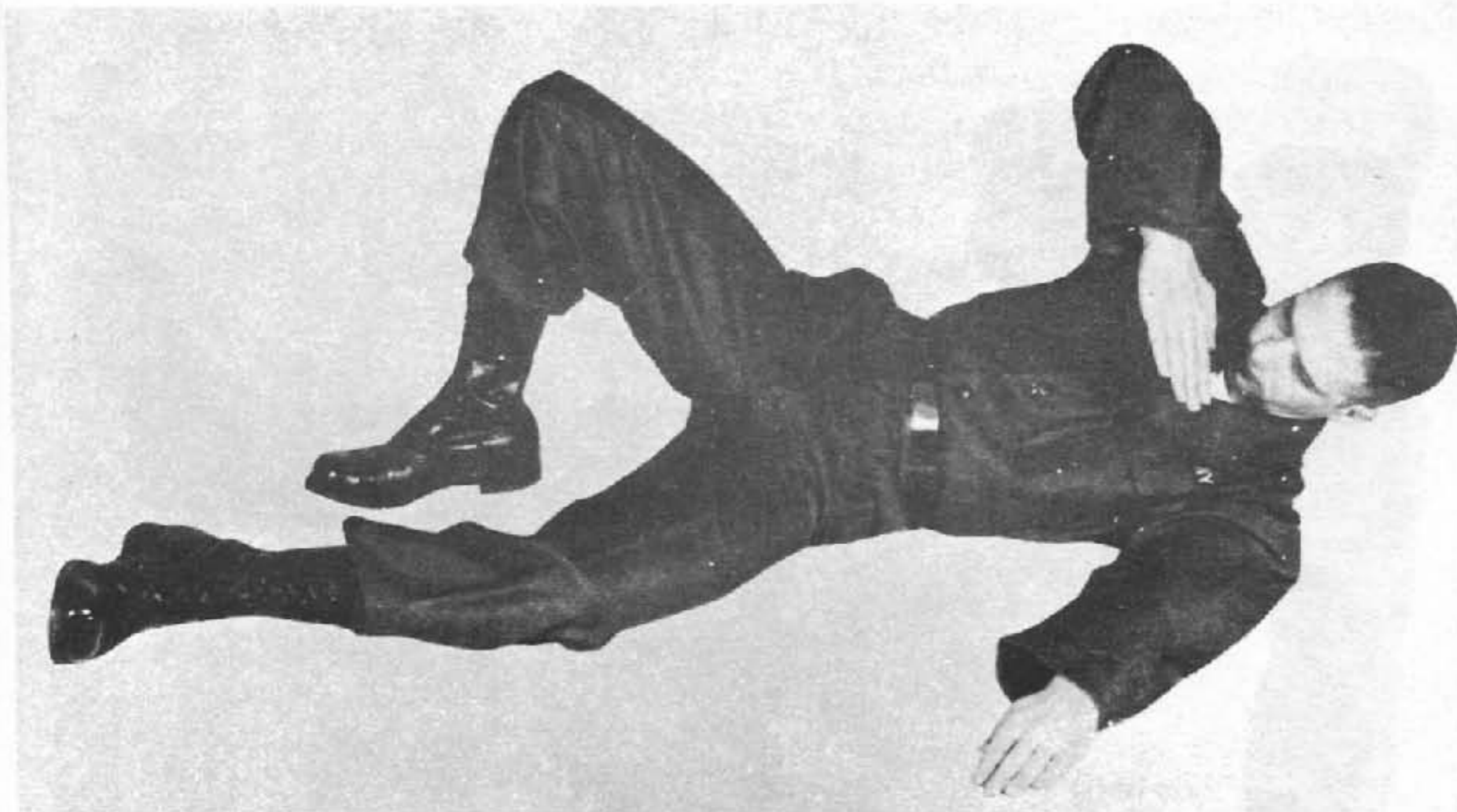

Figure 63. Left side fall position.

both fall positions the commands are, for example: LEFT SIDE FALL POSITION, MOVE; RIGHT SIDE FALL POSITION, MOVE; LEFT SIDE FALL POSITION, MOVE. This practice can be continued as desired by the instructor.

102. Practicing the Left Side Fall

To practice the left side fall the starting position (fig. 65) and execution (fig. 63), are the same as those for the right side, just substitute the words "left" for "right" and "right" for "left."

103. Rear Fall Position

a. Objective and Use. The objective of the rear fall is to land taking the impact of the fall on the shoulders, arms, and feet. This fall is used best when falling backward with insufficient momentum to go into a backward roll, or when your opponent throws you with an overhead throw (para 108).

b. Description. The points to check for the rear fall position (fig. 66) are as follows:

(1) The soles of your feet are driven to the ground about shoulder width apart, keeping your lower leg at a 90° angle to the ground. This takes up the initial shock of the fall.

(2) Both hands strike the ground in a slapping motion at the same time as your feet. The arms are extended fully, forming a 45° angle to your body, and the palms of your hands are down. This slapping motion gives you contact with the ground along both arms and across the shoulders, taking up additional shock of the fall.

(3) Keep your stomach muscles tightened so your buttocks will not strike the ground when you land. This prevents injury to your spine.

(4) Your chin is tucked into your chest so that your head does not strike the ground.

c. Followup or Recovery. As in other falling positions the proper action is to regain your feet quickly.

d. Instruction and Commands. The rear fall position is taught in two phases:

(1) REAR FALL POSITION, PHASE ONE, MOVE; at this command assume the preparatory position as specified in paragraph 104a.

(2) PHASE TWO, MOVE; on this command roll forward and execute the fall as described in paragraph 104b. At normal speed the command is REAR FALL POSITION, MOVE.

104. Practicing the Rear Fall Position

a. Starting Position (fig. 67). Assume the squatting position and place your hands between your knees, with the palms flat on the ground and fingers pointing toward each other. Arch your back and tuck your chin into your chest to keep your head from striking the ground.

b. Execution. Roll forward in a somersault. At the peak of the forward roll, drive the soles of the feet to the ground about shoulder width apart and simultaneously slap both hands to the ground. The arms are extended fully with the hands palm down,



Figure 64. Starting position to practice right side falls.



Figure 65. Starting position to practice left side falls.



Figure 66. Rear fall position.



Figure 67. Starting position to practice rear fall.

forming a 45° angle to your body. The chin remains tucked tightly into the chest to prevent the head from hitting the ground. The completed fall should be the same as in figure 66.

105. Advance Falling Practice

a. Right Side Fall. Start from the standing position and raise your left arm over your head with the palm of your hand facing to the left. Take several steps forward to build up momentum. When your left foot strikes the ground swing your raised left arm down in an arc through your legs so that you go into a forward somersault. Keep your chin tucked into your chest. At the peak of your forward roll thrust your flexed legs so that your body is

propelled into the air feet first and parallel to the ground in an extended position. The sole of your left foot and the palm of the right hand are driven to the ground and make the initial contact to absorb most of the shock. The completed fall position should be the same as in figure 62.

b. Left Side Fall. The left side fall position (fig. 76) can be practiced in a similar manner, substituting the words "left" for "right" and "right" for "left."

c. Rear Fall Position. Start from the standing position and take a few steps forward to build up momentum. Then execute the fall as described in paragraph 104.

Section III. TAKEDOWNS AND THROWS

106. Hip Throws

a. Objective and Use. The objective of a hip throw is to break your opponent's balance and quickly and forcefully throw him to the ground. The best use of a hip throw is when you can move in quickly and complete the movement prior to your opponent's ability to react.

b. Description.

(1) Start the right hip throw from the front guard position (facing your opponent). Place your left foot in front and slightly inside of your opponent's left foot. At the same time, strike your opponent vigorously on his right shoulder with the heel of your left hand and grab his clothing at the shoulder (①, fig. 68). This blow knocks him off balance to his rear.

(2) Pivot to your left 180° on the ball of your left foot. During the pivot place your right arm around your opponent's waist and jerk him forcefully with both arms, driving your buttocks into his midsection. This maneuver bends your opponent over your right hip at his waist and leaves him partially suspended in this position. At the completion of this maneuver your knees are bent, feet shoulder width apart, and your body is bent forward at the waist (②, fig. 68).

(3) Straighten your legs quickly, thrusting your buttocks forcefully into your opponent's midsection. At the same time, bend forward at the waist and pull forward and downward with both arms, driving your opponent to the ground (③, fig. 68). Use your hip as a balance point, throwing the man over your right hip and not over the outside of your leg. At the completion of the throw your opponent should land in the left side fall position.

(4) To execute a left hip throw substitute the

word "left" for "right" and "right" for "left."

c. Followup or Recovery. Your opponent will fall at your feet and will be open to kicks, stomps, or blows. The followup must be rapid as the fall in itself usually is not disabling.

d. Instruction and Commands. The hip throws (right or left) are taught in three phases:

(1) RIGHT HIP THROW, PHASE ONE, MOVE; on this command place the feet and destroy your opponent's balance as specified.

(2) PHASE TWO, MOVE; on this command place your arm around your opponent's waist and suspend him on your hip.

(3) PHASE THREE, MOVE; on this command complete the action by throwing him to the ground. At normal speed the command is RIGHT (or LEFT) HIP THROW, MOVE.

107. Shoulder Throw

a. Objective and Use. The objective of the shoulder throw is to use your opponent's momentum to throw him across your shoulder to the ground. This throw is used when your opponent is attacking directly to your front, with his fists or both arms in the air.

b. Description.

(1) Your throw begins from the front guard position. As your opponent directs a blow to your head or upper body with his right hand, block his blow somewhere between the knife edge of your left hand and your left elbow. Step forward with your left foot, placing it slightly in front of and centered on your opponent's feet. Simultaneously, grasp your opponent's right wrist with your left hand and pull him forward and off balance (①, fig. 69).

(2) Pivot 180° to your left on the ball of your left foot and plant your right foot immediately on

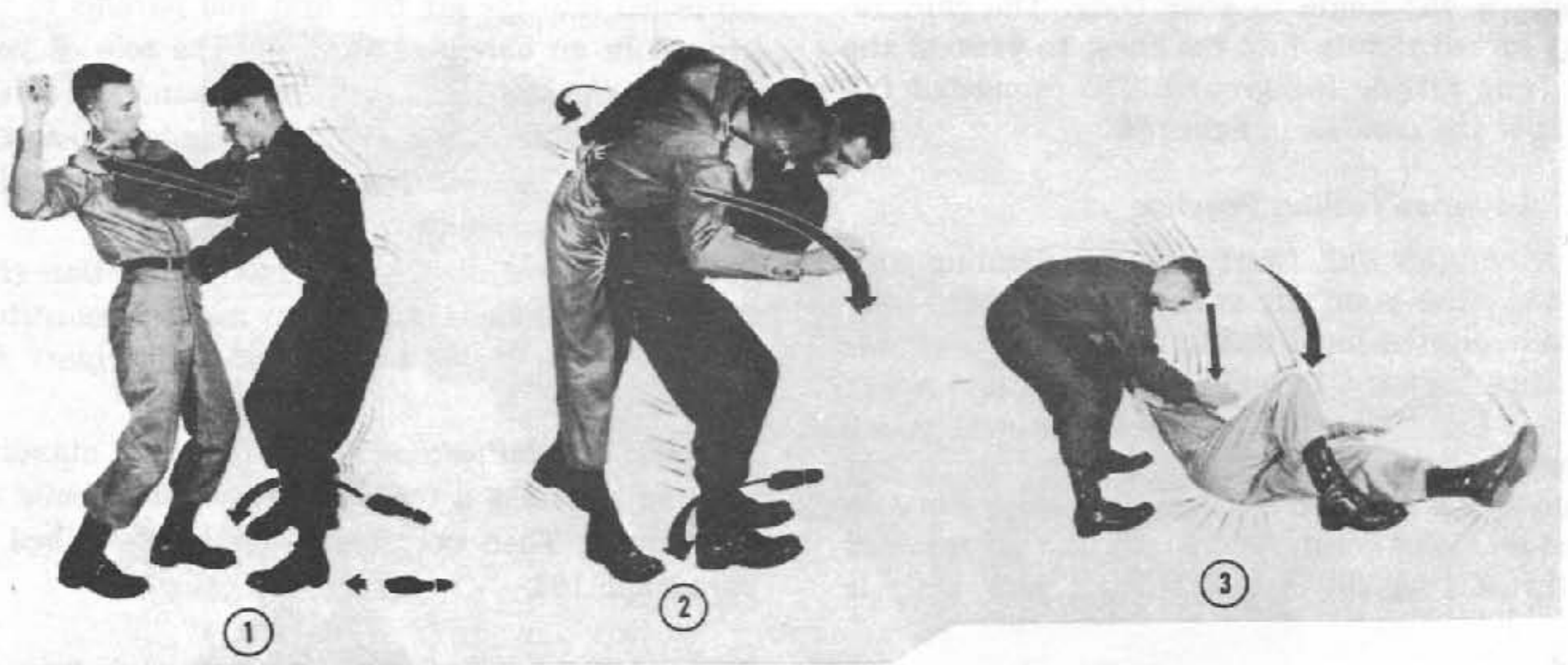

Figure 68. Right hip throw.

line to the outside of your opponent's right foot. At the same time, forcefully drive your upper right arm into your opponent's right armpit and pull his right arm tightly across your chest with your left hand. You now have good buttocks-to-groin contact with your opponent, your hips are on line, your back is erect, your knees are flexed and your opponent is off balance to the front (②, fig. 69).

(3) Turn your head and eyes to the left, pivot approximately 90° to the left on the ball of your left foot, and drop to your right knee. At the same time, pull your opponent downward to the left with your left hand rotating the upper portion of your body to the left rear in a circular motion. Maintain your grasp on your opponent's right wrist with your left hand (③ and ④, fig. 69).

c. Followup or Recovery. If you maintain your grasp on your opponent's right wrist, he will land directly to your front with his right arm across your left knee (⑤, fig. 69). Push down with your left hand at his wrist and your right hand at his shoulder to break his elbow or dislocate his shoulder.

d. Instruction and Commands. The over-shoulder throw is taught in three phases:

(1) SHOULDER THROW, PHASE ONE, MOVE; on this command step forward, block your opponent's blow, grasp your opponent's right wrist and pull him forward and off balance.

(2) PHASE TWO, MOVE; on this command, pivot to the left and drive your upper right arm into your opponent's right armpit.

(3) PHASE THREE, MOVE; on this command, continue pivoting to the left, drop to your right knee, pull your opponent to the ground in a circular motion to your left rear. At normal speed the command is SHOULDER THROW, MOVE.

108. Overhead Throw

a. Objective and Use. The objective of the overhead throw is to take full advantage of your opponent's momentum and throw him over your head. This throw is used when your opponent is rushing directly at you.

b. Description.

(1) You start this throw from the guard position, facing your opponent who is about five or six steps away. As your opponent rushes forward you grab his lapels with both hands. Simultaneously you raise either your left or right leg and place the sole of your foot solidly against his stomach (①, fig. 70).

(2) Still maintaining the hold on your opponent's lapels, and with your foot against his stomach, drop down until your buttocks strike the ground and you are in a sitting position. Continue moving backward until your back and shoulders touch the ground, keeping your opponent pulled firmly against your foot. Using your opponent's momentum, pull him with your hands until he is suspended over your body on your foot (②, fig. 70).

(3) Catapult your opponent into the air by maintaining a tight handhold and thrusting your leg vigorously into his stomach and arching your back so that you rock back onto your shoulders. Your opponent assumes the rear fall position (③, fig. 70).

(4) By maintaining a firm grip with your hands on his lapels you will be pulled over, completing a rear somersault and landing astride your opponent's chest (④, fig. 70).

c. Followup or Recovery. If you hold on to your opponent at the conclusion of the throw you should be astride his chest. From this position strike or

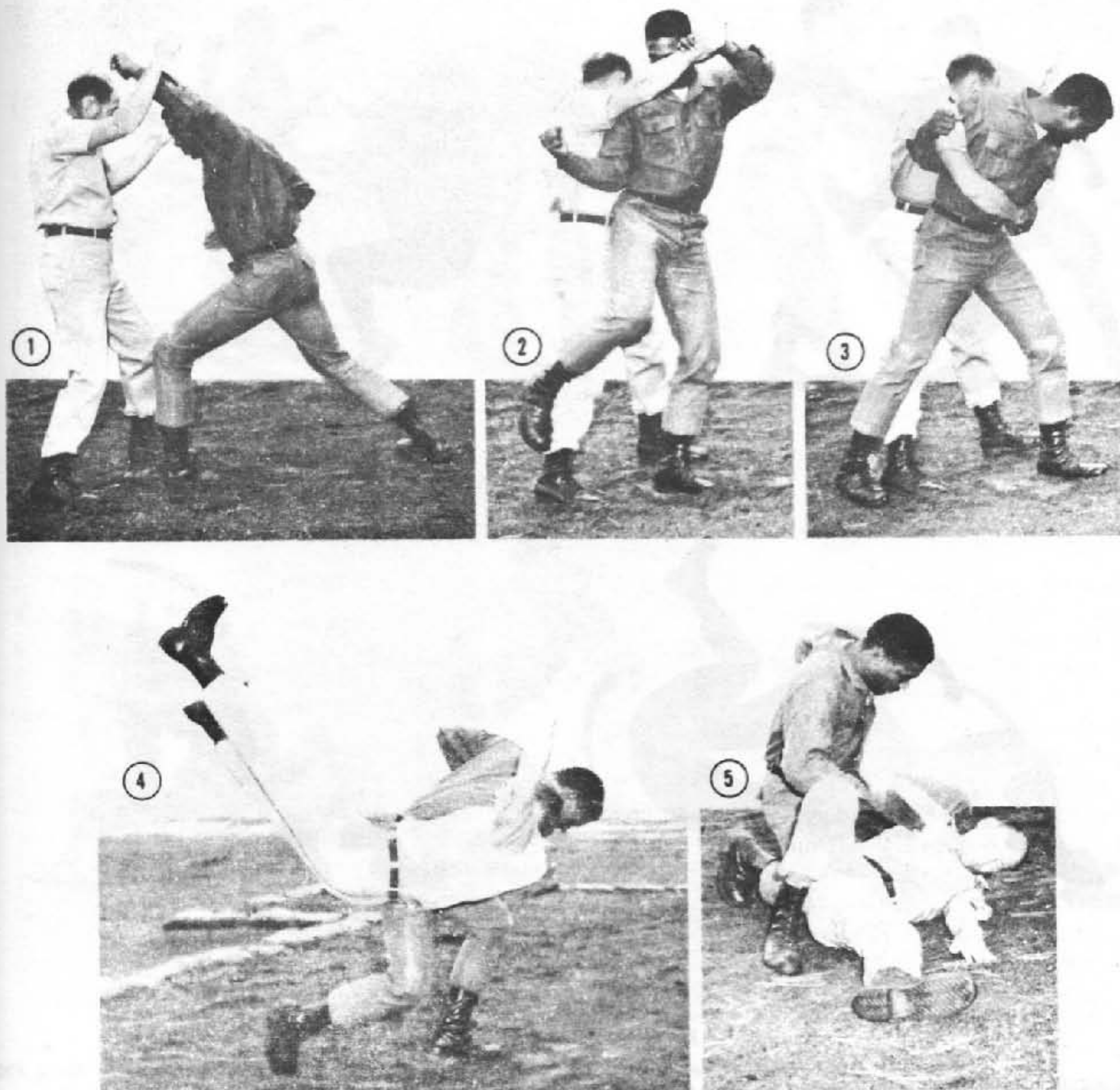

Figure 69. Shoulder throw.

attack a vulnerable body part with a chop or jab or apply a strangle hold. If you lose your hold your opponent will get away, in such case get to your feet and continue the attack as appropriate.

d. Instruction and Commands. The overhead throw is not taught by command phases. There are, however, three parts to the instruction process. The instructor first should explain each part of the throw and at the same time have men apply the action. After they understand the throw, then practice a "walk-through," and finally an actual "run-through" at normal speed. To successfully execute this throw there must be a certain amount of momentum involved and the opponent must know and use the rear fall position to avoid injury during

training. The command at normal speed is OVER-HEAD THROW, MOVE.

109. Body Block

a. Objective and Use. The objective of the body block is to counter your opponent's rush and at the same time cause him to fall to the ground. The body block is used when your opponent is running at you attempting to knock you down with his forward movement.

b. Description. When the opponent rushes you wait until it is too late for him to stop. Step back with either foot, turning your side toward him (①, fig. 71). As you turn away from him flex your knees, bend well over at the waist. You must get

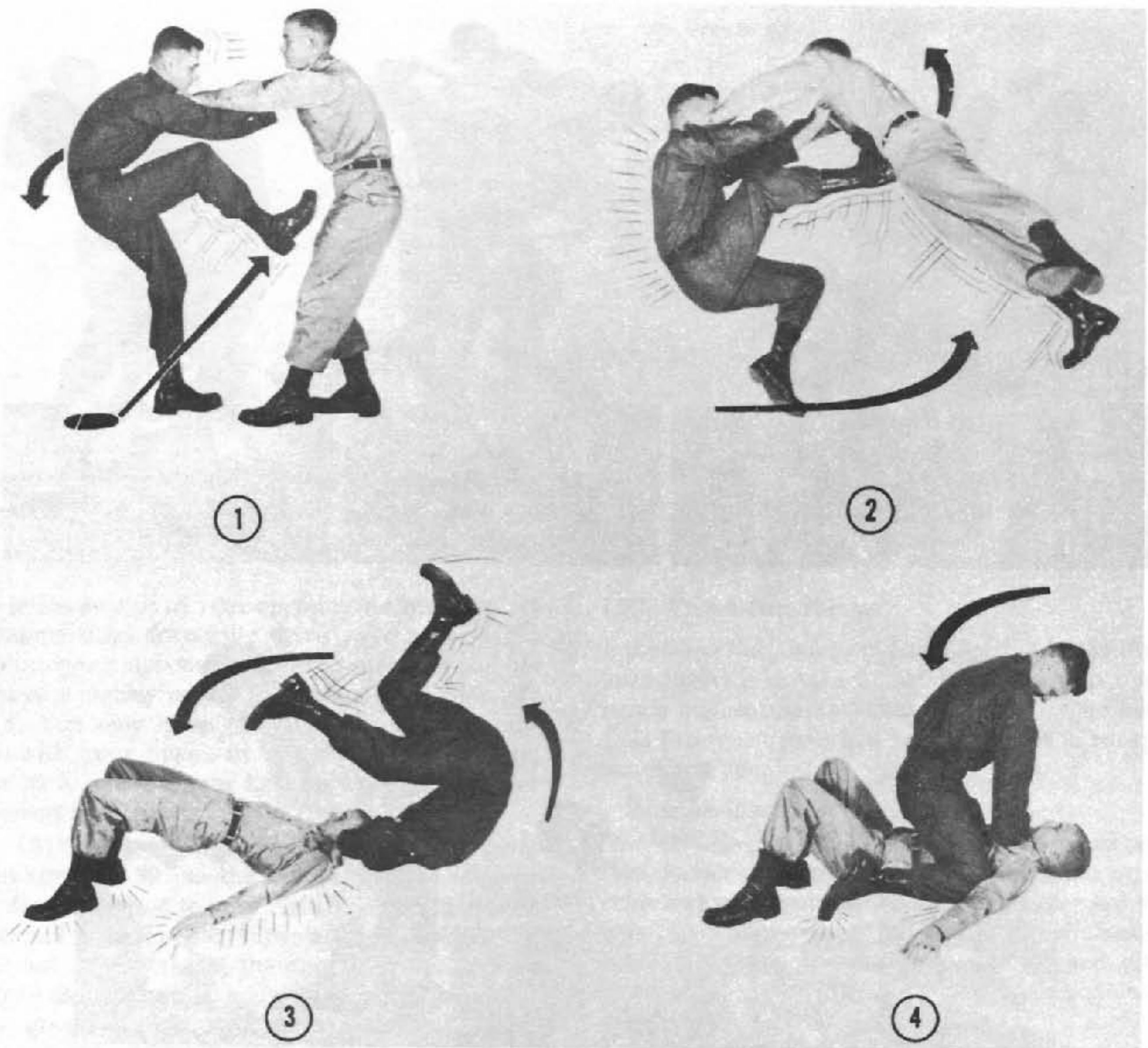

Figure 70. Overhead throw.

your back lower than his belt line (②, fig. 71). Brace yourself with the foot you thrust to the rear. As his momentum carries him over your back, thrust your arm back and up. Lift his leg or thrust your arm between his legs. As you do this straighten your legs fast and hard, throwing him over your back (③, fig. 71).

c. Followup or Recovery. The impact of falling may stun or disable your opponent. If this is the case move in and kick a vital body area. If he regains his feet before you are able to follow up you must continue the attack as appropriate to the situation.

d. Instruction and Commands. This movement is not executed at normal speed during training as the opponent's fall cannot be controlled. Men are instructed as to the technique, and practice a "walk-through" up to the point where the opponent is thrown. The command is BODY BLOCK, MOVE.

110. Overshoulder Throw

a. Objective and Use. The objective of the overshoulder throw is to grasp your opponent and propel him over your shoulder and head onto the ground. This throw is used best when your opponent is stationary and nonaggressive.

b. Description.

(1) Start the overshoulder throw from the guard position (facing your opponent). The first phase of this throw is identical to the first phase of the right hip throw and the footwork is identical throughout to that used in the right hip throw. Place your left foot in front and slightly inside of your opponent's left foot. At the same time, strike him vigorously on his right shoulder with the heel of your left hand and grab his clothing (①, fig. 72).

(2) Pivot to your left 180° on the ball of your left foot. Keep your right arm in position to pro-

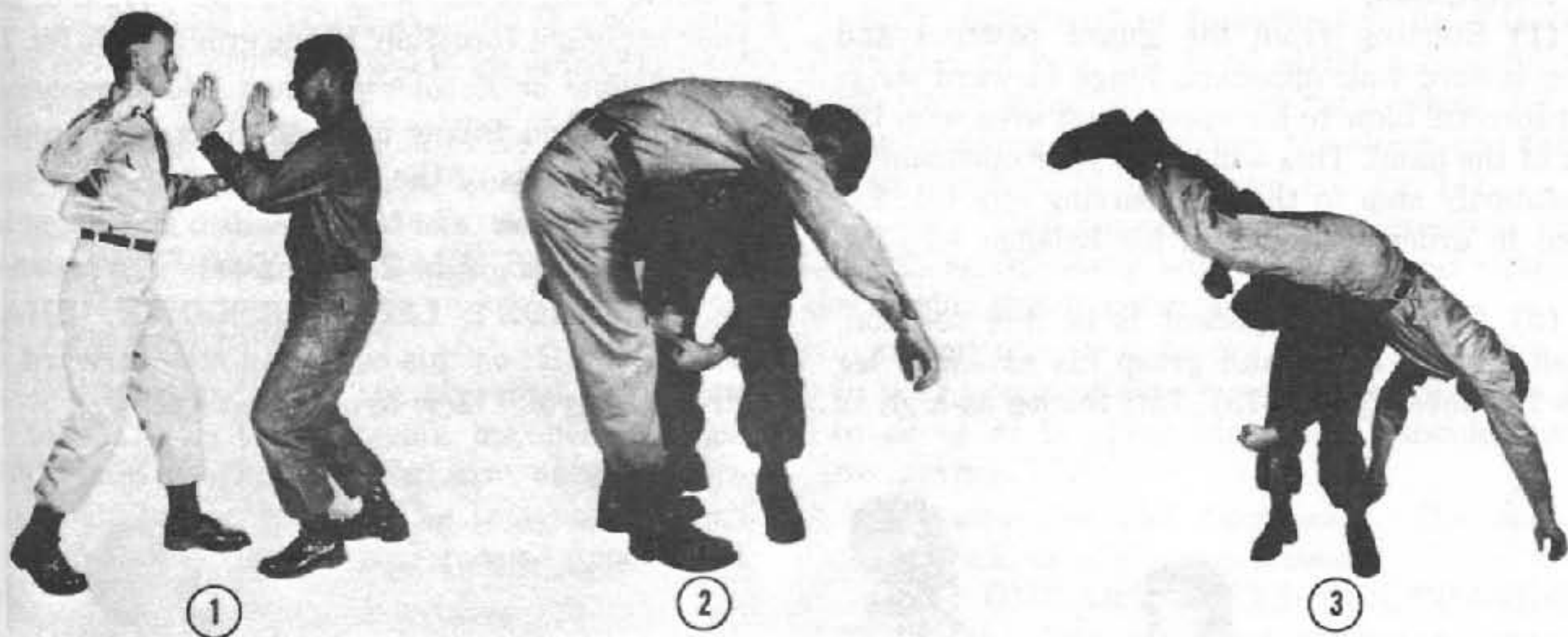

Figure 71. Body block.



Figure 72. Overshoulder throw.

protect your head and neck region until you near the completion of the pivot. Reach up and grab your opponent's clothing at his right shoulder with your right hand, and then grip him at this point with a double-hand hold. As you complete the pivot, pull your opponent forward and drive your buttocks into his midsection (②, fig. 72). Your buttocks are directly in front of your opponent's hips, your right foot is in front and slightly outside of your opponent's right foot, your elbows are as close to your body as possible, and your knees are bent.

(3) Straighten your legs, bend at the waist, and pull downward with both hands. This action will catapult your opponent over your shoulder (③, fig. 72). He assumes the rear fall position as he strikes the ground.

c. Followup or Recovery. Your opponent will fall with his head close to your feet. A stomp or kick is the best followup action.

d. Instruction and Commands. The overshoulder

throw is taught in three phases:

(1) **OVERSHOULDER THROW, PHASE ONE, MOVE;** on this command step forward, destroy your opponent's balance, and grasp his clothing.

(2) **PHASE TWO, MOVE;** on this command pivot, complete your hold and suspend your opponent upon your buttocks.

(3) **PHASE THREE, MOVE;** on this command throw him to the ground over your head. At normal speed the command is **OVERSHOULDER THROW, MOVE.**

111. Front Leg Takedown

a. Objective and Use. The objective of the front leg takedown is to upset your opponent's balance and take him down by pulling one leg out from under him. This takedown is used when the opponent is hesitant or when you are close to him and he is attempting to grasp you.

b. Description.

(1) Starting from the guard position and facing toward your opponent, lunge forward striking a forceful blow to his upper chest area with the palm of the hand. This will cause your opponent to momentarily step to the rear leaving one foot extended in order to maintain his balance (①, fig. 73).

(2) Once your opponent is in this position, instantly reach down and grasp his extended leg below the knee (②, fig. 73). Lift the leg as high as

possible with both hands (③, fig. 73) and push your opponent forcefully to the ground (④, fig. 73).

c. Follow or Recovery. When your opponent is on the ground follow up with kicks or stomps to vulnerable areas of the body.

d. Instruction and Commands. The front leg takedown is taught in three phases:

(1) FRONT LEG TAKEDOWN, PHASE ONE, MOVE; on this command step forward and strike a forceful blow to opponent's chest.



Figure 73. Front leg takedown.

(2) PHASE TWO, MOVE; on this command grasp your opponent's leg and lift it approximately waist high.

(3) PHASE THREE, MOVE; on this command raise the leg as high as possible and push your opponent to the ground. At normal speed the command is FRONT LEG TAKEDOWN, MOVE.

112. One Arm Takedown

a. Objective and Use. The objective of the one arm takedown is to block your opponent's punch or blow and use his extended arm as a lever to throw him to the ground. The best use is when your opponent strikes at your face or upper chest area.

b. Description.

(1) Starting from the guard position quickly shift your body to the left of your opponent's blow, at the same time deflecting the blow with the outside portion of the right forearm (①, fig. 74). In deflecting the blow immediately grasp your oppo-

nent's right wrist or forearm (②, fig. 74). With the heel of your left hand strike a forceful blow into your opponent's locked right elbow (③, fig. 74) breaking or dislocating the elbow and forcing your opponent to the ground (④, fig. 74).

(2) This movement can be executed on an opponent thrusting with his left hand simply by reversing the procedures outlined above.

c. Followup or Recovery. Follow up with a blow to your opponent's neck or kidney area, or a kick, to assist in bringing him down (should that be necessary).

d. Instruction and Commands. The one arm takedown is taught in two phases:

(1) ONE ARM TAKEDOWN, PHASE ONE, MOVE; on this command block the opponent's blow and grasp his arm.

(2) PHASE TWO, MOVE; on this command strike his elbow and force him to the ground. At normal speed the command is ONE ARM TAKEDOWN, MOVE.

Section IV. BAYONET DISARMING

113. General

In combat any of the methods described in this section can be used to disarm an opponent whether he uses a long or short thrust. In training, however, you are taught bayonet disarming methods for both long and short thrust attacks. The text differentiates between the short and long thrust to enable you to judge the distance between the bayonet point and your body when practicing these techniques. When practicing the short thrust, you should be approximately arm's length from the bayonet point. When practicing the long thrust the distance is increased by 1 foot. The unarmed soldier should wait until his armed opponent has committed himself before attempting a disarming maneuver.

114. Pull and Push Counter

a. Objective and Use. The objective is to disarm your opponent and throw him to the ground. This counter is used best when you are a short thrust distance from your opponent.

b. Description.

(1) If your opponent attacks you with a short thrust, twist your body to the left and at the same time step to your right front. At the same time, strike the bayonet with your right forearm to deflect the blade from your body (①, fig. 75).

(2) As soon as the bayonet has passed your body, grab your opponent's left hand with your right hand. At the same time, take a long step with

your left foot toward your opponent's right, reach under his rifle with your left hand, and press your left shoulder against the upper portion of the handguard. With your left hand, grab his right hand where it holds the small of the stock (②, fig. 75).

(3) Pull with your left hand and push with your right hand. Keep your weight on your left foot and kick your opponent so that the calf of your right leg makes calf-to-calf contact on his right leg (③, fig. 75).

(4) Your opponent will fall to the ground and loosen his grip on his rifle (④, fig. 75).

c. Followup and Recovery. After taking your opponent's rifle, deliver a butt stroke or bayonet thrust to a vital area of his body.

d. Instruction and Commands. This counter is taught in three phases:

(1) PULL AND PUSH COUNTER, PHASE ONE, MOVE; on this command twist your body, step to the right and deflect the bayonet with your right forearm.

(2) PHASE TWO, MOVE; on this command grasp his hands and press with the left shoulder as directed.

(3) PHASE THREE, MOVE; on this command pull and push with the hands and kick the calf of his right leg with your right leg. This action will cause him to fall to the ground. At normal speed the command is PULL AND PUSH COUNTER, MOVE.



①



②



③



④

Figure 74. One arm takedown.

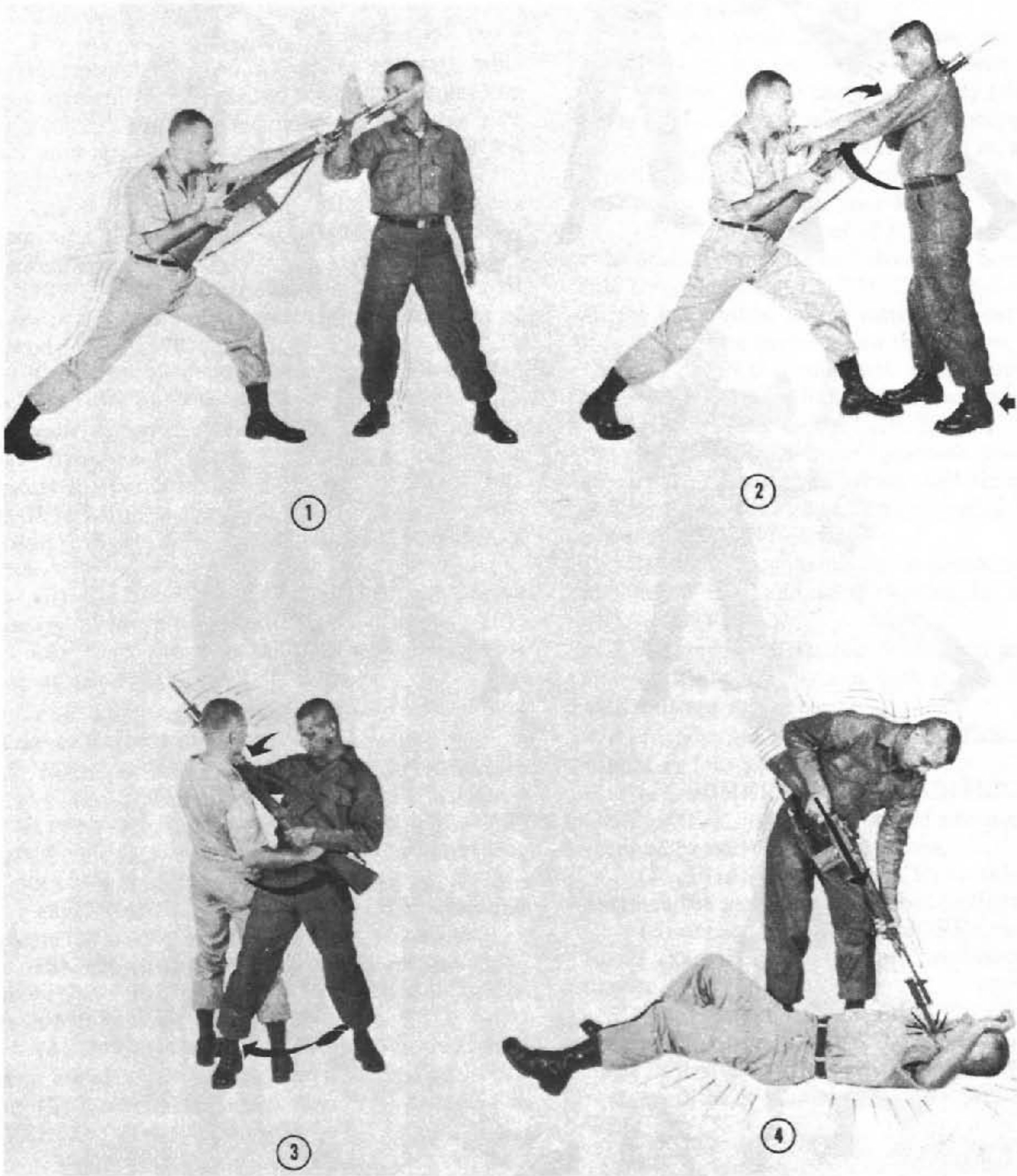

Figure 75. Pull and push counter.



Figure 76. Overleg counter.

115. Overleg Counter

a. Objective and Use. The objective of this counter is to disarm your opponent, gain possession of his rifle, and throw him to the ground. It is used best when he makes a long thrust at you.

b. Description.

(1) As your opponent executes the long thrust, parry the bayonet to your left with your right forearm and sidestep to the right oblique. You are now in a position facing the side of his rifle with your groin area protected by your right leg (①, fig. 76).

(2) With your left hand, palm up, grab your opponent's left hand and the rifle from underneath (②, fig. 76).

(3) Twist your body to the left in front of your opponent and place your right leg in front of his body (③, fig. 76).

(4) With the right hand, palm down, grab his rifle from above at the receiver. Pull the rifle and your opponent across your right leg. At the same time, exert pressure with your right side against the outside of his left arm and elbow (④, fig. 76). Sufficient pressure with your side while pulling on the rifle can break your opponent's elbow.

(5) Continue pulling your opponent across your leg, throwing him to the ground (⑤, fig. 76).

(6) Keep the rifle and follow through with your attack (⑥, fig. 76).

c. Followup or Recovery. Follow up with a butt stroke or bayonet attack.

d. Instruction and Commands. This counter is taught in four phases:

(1) OVERLEG COUNTER, PHASE ONE, MOVE; on this command execute the movement as described in *b* (1) above.

(2) PHASE TWO, MOVE; on this command execute the movement described in *b* (2) above.

(3) PHASE THREE, MOVE; on this command perform the movement specified in paragraph *b* (3) above.

(4) PHASE FOUR, MOVE; on this command complete the counter as described in *b* (4) and (5) above. At normal speed the command is OVERLEG COUNTER, MOVE.

116. Somersault Counter

a. Objective and Use. The objective of this counter is to disarm your opponent, take his rifle, and throw him to the ground. It is used best when he is making a vigorous long thrust at you.

b. Description.

(1) As your opponent executes the long thrust, parry his bayonet to your right with your left forearm. As you parry with your left forearm, move your body to the left oblique, stepping off to your left front with your left foot. You are now in a position facing his rifle from the side with your groin area protected by your left leg (①, fig. 77).

(2) With the palms of your hands, strike his rifle near the muzzle and drive the bayonet point into the ground (②, fig. 77). Do not follow the rifle all the way down. Allow your opponent's momentum to ram the bayonet into the ground.

(3) Grab the rifle butt with your left hand and with your right hand grab your opponent anywhere on his back or head (③, fig. 77).

(4) To disarm your opponent you drive the stock to his rifle into his body and simultaneously pull him with your right hand, spinning him to the ground (④, fig. 77).

(5) Now you should be in possession of your opponent's rifle and in a position to attack him (⑤, fig. 77).

c. Followup or Counter. When you gain possession of his rifle deliver a butt stroke or bayonet attack as appropriate.

d. Instruction and Commands. This counter is taught in four phases:

(1) SOMERSAULT COUNTER, PHASE ONE, MOVE; on this command execute the movement as prescribed in *b* (1) above.

(2) PHASE TWO, MOVE; on this command perform the movement described in *b* (2) above.

(3) PHASE THREE, MOVE; on this command execute the movement prescribed in *b* (3) above.

(4) PHASE FOUR, MOVE; on this command complete the counter by executing the movement as described in *b* (4), and (5) above. At normal speed the command is SOMERSAULT COUNTER, MOVE.

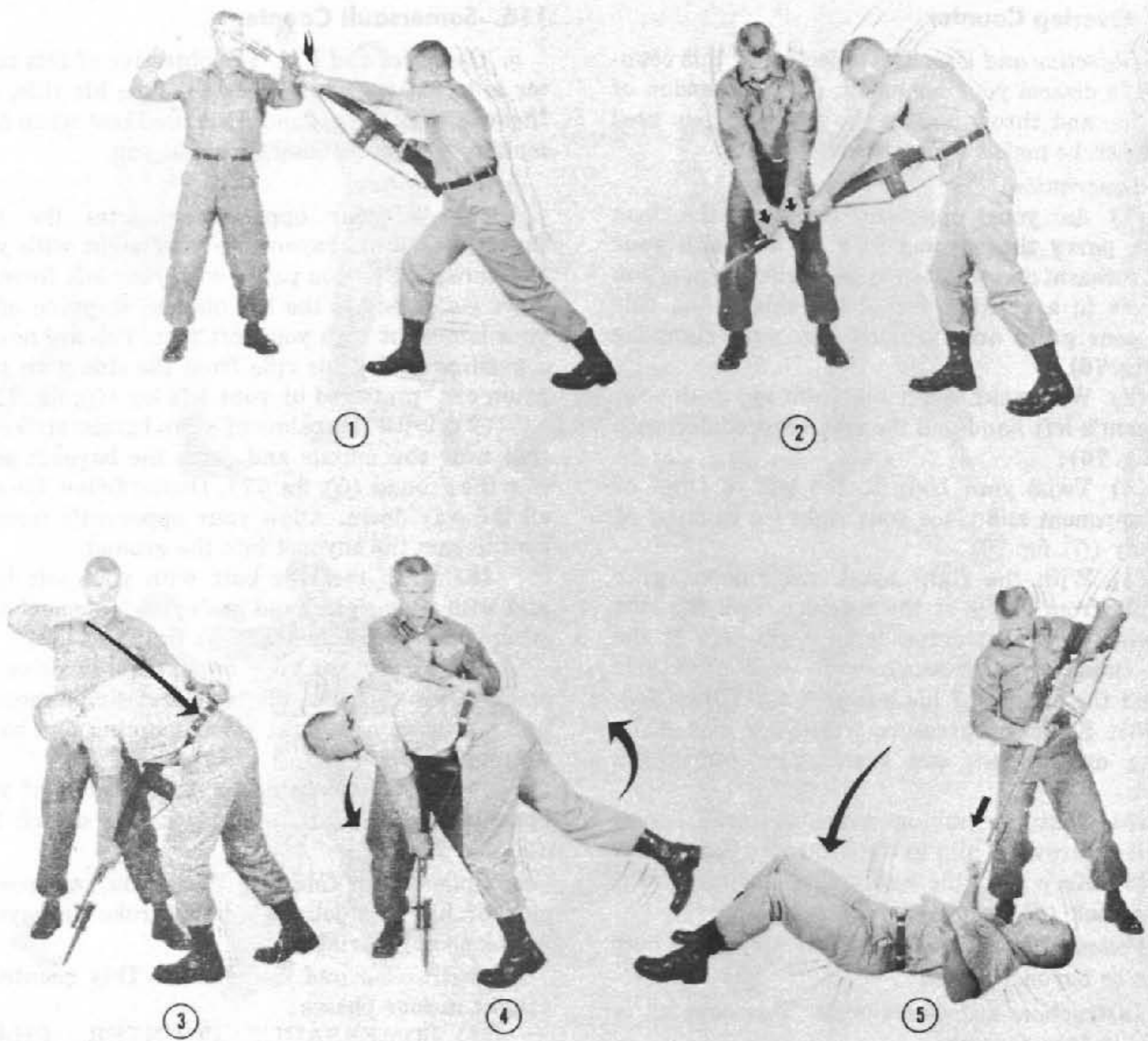

Figure 77. Somersault counter.

Section V. KNIFE ATTACK AND DEFENSE

117. General

A knife (or bayonet), properly employed, is a deadly weapon. You can use it on patrols to silence an enemy sentry or you can use it for close-in fighting when you do not have a rifle.

118. Grip

a. The proper knife grip is essential for maximum control. To form a proper grip begin by laying the knife diagonally across the out-stretched palm of your hand (①, fig. 78).

b. Grasp the small part of the handle next to the cross guard with your thumb and forefinger. Your middle finger encircles the handle at its largest point (②, fig. 78). Do not hold the knife too tightly.

c. When the knife is held in this manner it can be maneuvered in all directions. You can control the direction of the blade by a combination movement of the forefinger and middle finger and a turning of the wrist. When the palm is turned up and you are holding the knife in your right hand, you can slash to the right or left. When the palm is turned down, you also can slash in either direction. You can thrust when the palm is held either up or down. Just before the knife makes contact you hold it tightly with all fingers (③, fig. 78).

119. Stance

When engaging in a knife attack your stance (fig. 79) is similar to the front guard position. The only difference is the position of your arms.

The knife is held waist high and in front of your body. Your left arm and hand act as a guard or foil and help create an opening for a slash or thrust. You also may use your left hand to distract your opponent's attention by throwing something or by

A deep wound in the stomach causes death if the wound is unattended.

c. *The Heart.* A thrust into the heart causes almost instant death (③, fig. 81). This spot is difficult to hit because of the protecting ribs. A hard

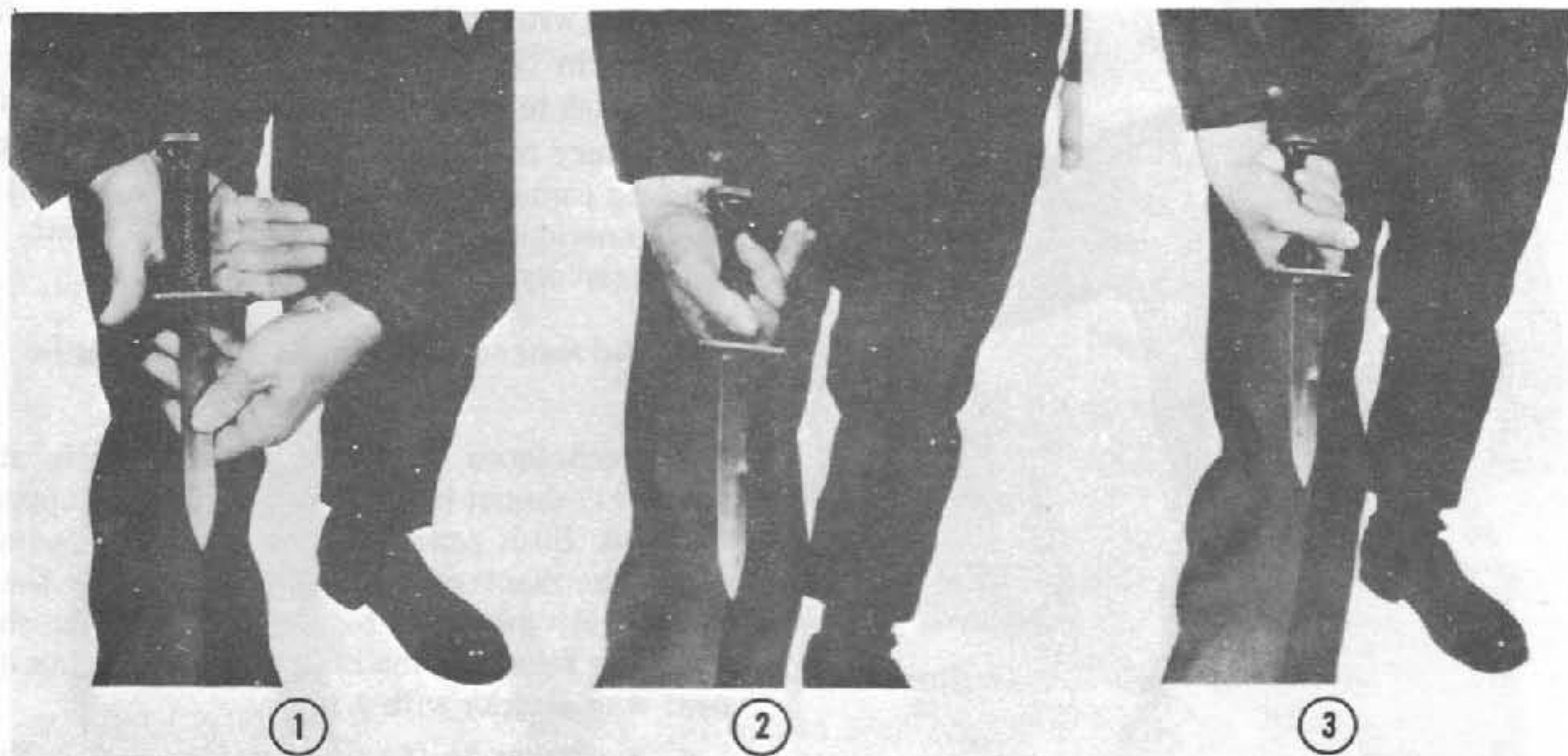

Figure 78. Gripping the knife.

making a sudden darting motion toward him. When you are in this stance your knees are bent to provide mobility and balance. In this stance, you also are able to protect your midsection and throat area.

120. Modified Stance

In the modified stance (fig. 80) you conceal the knife until your opponent knows what you have or until you thrust or slash with it. The knife is concealed behind the right leg.

121. Front Attack

When you attack an opponent from the front with a knife he instinctively tries to protect his stomach and throat. If he is wounded in one of the places his fear may be so great that he forgets to defend himself and you can kill him.

a. *The Throat.* You can attack the throat with either a thrust or a slash. The thrust is most effective if the knife is driven into the base of the throat just below the Adam's apple (①, fig. 81). This type blow cuts the jugular vein and results in almost instant death. A slash to either side of the neck cuts the carotid artery which carries blood to the brain. Your opponent will die within a few seconds from loss of blood.

b. *The Stomach.* A thrust combined with a slash to the stomach produces great shock (②, fig. 81). Your opponent will be stunned and unable to defend himself. You can then deliver a killing blow.

thrust, however, usually will slip off the rib and penetrate the heart.

d. *The Wrist.* A slash to the wrist will sever the radial artery, causing death within 2 minutes (④, fig. 81). This type of attack is excellent if your opponent attempts to grab your clothing or arm. The radial artery is one-quarter inch below the surface of the skin. Unconsciousness results in about 30 seconds.

e. *The Upper Arm.* A slash to the upper arm just above the inside of the elbow cuts the brachial artery and causes death within 2 minutes (⑤, fig. 81). This artery is about one-half inch below the skin surface. Unconsciousness occurs in about 15 seconds.

f. *The Leg.* A slash to the inside of the leg near the groin severs the arteries there and makes the leg useless (⑥, fig. 81).

122. Attack From the Rear

When attacking an opponent from the rear you should launch your attack immediately upon reaching a position not less than 5 feet from him.

a. *The Kidney.* Thrust the knife into your opponent's kidney and simultaneously grab his mouth and nose with your other hand (①, fig. 82). After a short interval withdraw the blade, slashing as you do so, and then cut his throat. The thrust to the kidney produces great shock and causes internal hemorrhage and death.



Figure 79. Stance with knife.

b. Side of the Neck. A thrust into the side of the neck is effective when you want to maintain silence (②, fig. 82).

c. The Throat. A slash across the throat from

the rear severs the windpipe and jugular vein (③, fig. 82).

d. The Subclavian Artery. The subclavian artery is approximately 2½ inches below the surface between the collarbone and the shoulder blade. Attack this spot with a thrust by gripping the knife as depicted in ④, figure 82. As you withdraw the knife, slash to make the wound as large as possible. This artery is difficult to hit, but once it is cut the bleeding cannot be stopped and your opponent will lose consciousness within seconds. Death will follow rapidly.

123. Advanced Techniques Against Knife Attack

Basic techniques of defense against knife attack (para 94) do not prescribe disarming the opponent by hand. Such practice is an advanced technique due to the exactness necessary to complete the disarming. An advanced hand-to-hand fighter should know the following methods of disarming an opponent who attacks with a knife.

a. A counter to the downward stroke is shown in figure 83. Block your opponent's arm by bending your left fist forward and making contact with his wrist. Step through with your right foot to protect your groin. Keeping your left arm horizontal, bring your right hand underneath the upper part of your opponent's knife arm and grasp your left fist (①, fig. 83). Bend forward swiftly from the waist and put pressure on your opponent's arm (②, fig. 83). This causes him to release his knife and fall backward.

b. A counter to the upward stroke is shown in figure 84. Catch your opponent's wrist or forearm in the "V" formed by crossing your arms at the wrist. At the same time, glide slightly to the rear to keep the knife from cutting your stomach (①, fig. 84). Upon stopping his blow, grab your opponent's right hand with your left hand and place your thumb on the back of his hand. Reinforce this hold by grabbing his wrist with your right hand and place your left thumb on the back of his hand (②, fig. 84). Twist his wrist to his left and bend his hand toward his forearm causing him to fall to the ground (③, fig. 84).



Figure 80. Modified stance with knife.



1. KNIFE ATTACK AT BASE OF THROAT.



2. KNIFE ATTACK TO THE STOMACH.



3. KNIFE ATTACK TO THE HEART.



4. KNIFE ATTACK TO THE WRIST.



5. KNIFE ATTACK TO THE UPPER ARM.

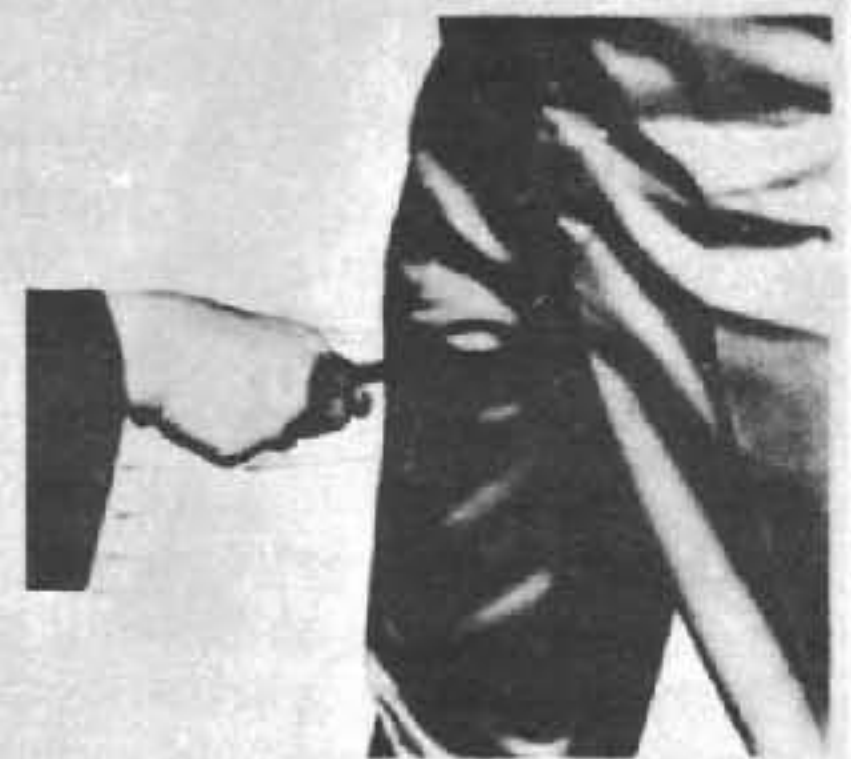

6. KNIFE ATTACK TO LEG.

Figure 81. Frontal knife attack to vital body areas.



1. KNIFE ATTACK FROM REAR TO THE KIDNEY.



2. KNIFE ATTACK FROM REAR TO SIDE OF THE NECK.

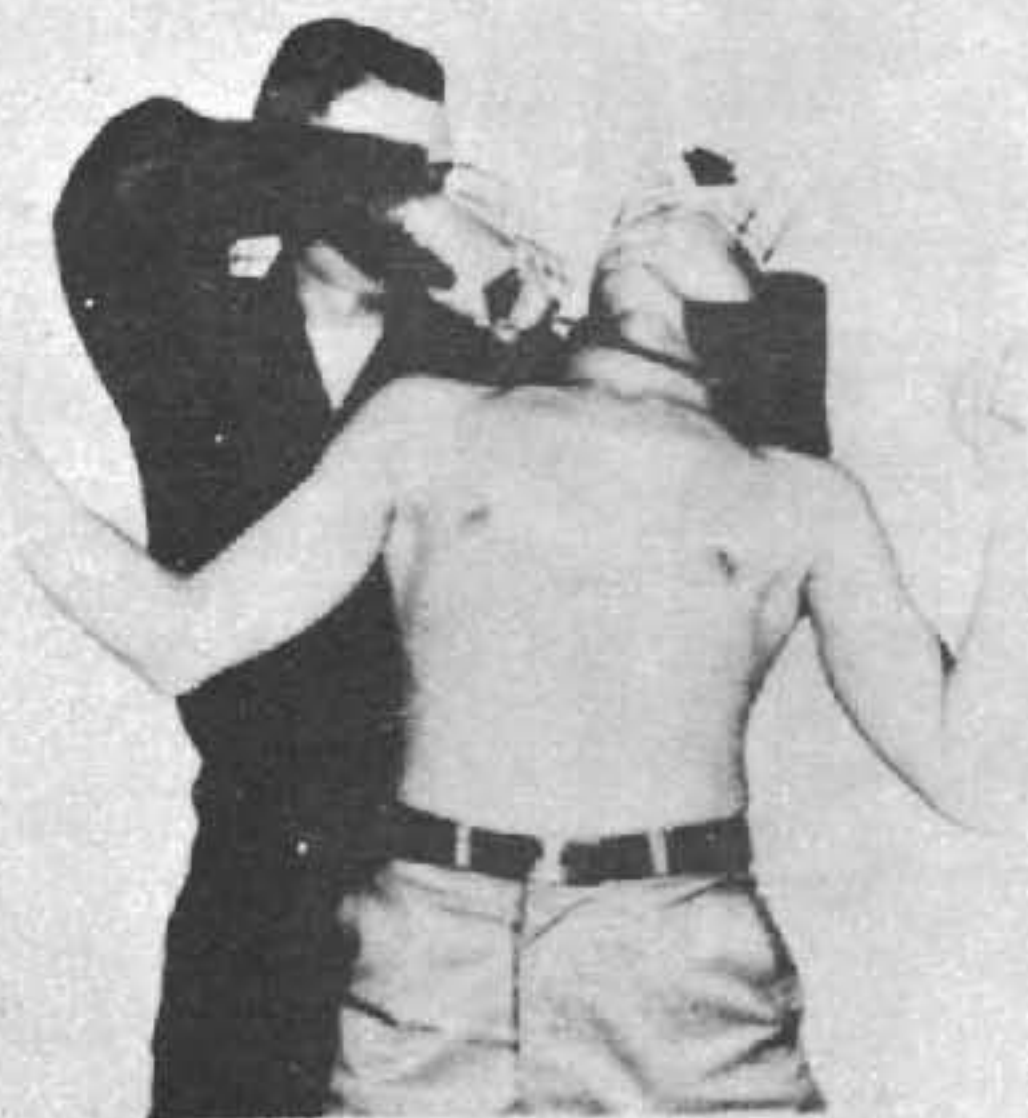

3. KNIFE ATTACK FROM REAR TO THE THROAT.



4. KNIFE ATTACK FROM REAR TO THE SUBCLAVIAN ARTERY.

Figure 82. Knife attack, from the rear, to vital body areas.



1. SECOND COUNTER AGAINST
DOWNWARD STROKE.

①



2. CONTINUED.

②

Figure 88. Counter against downward stroke.

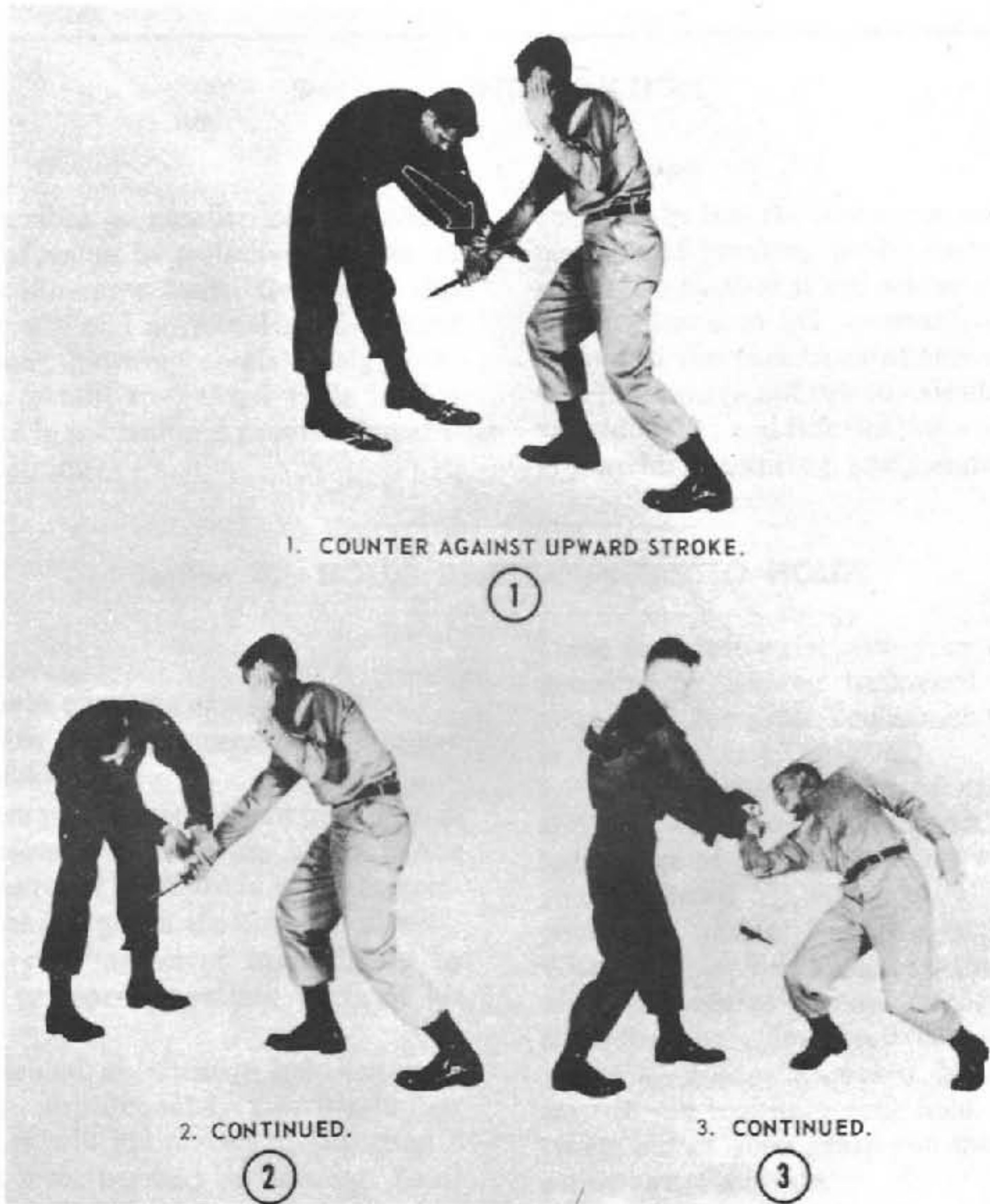

Figure 84. Counter against upward stroke.

This Page Intentionally Left Blank

CHAPTER 8

SPECIALIZED SKILLS

Section I. INTRODUCTION

124. Purpose

This chapter describes a number of specialized skills which are of value to a limited number of soldiers on a need-to-know basis. Generally, this training follows basic and advanced hand-to-hand fighting instruction; however special assignment may dictate that certain specialized skills in this chapter be included in the training program regardless of previous training.

125. Scope

Included in this chapter are a variety of holds and methods of breaking holds; come-along techniques which can be used if the soldier does not, for some reason, desire to kill or disable his opponent; descriptions for variations of throws and takedowns which are more difficult to execute than similar advanced skills; and information concerning methods of searching, securing, and gagging prisoners.

Section II. HOLDS AND COUNTERS TO HOLDS

126. General

a. The three main purposes of a hold are:

(1) To subdue your opponent until you can secure him for safekeeping.

(2) To injure your opponent and place him in a position to receive your followup blows to the more vulnerable parts of his body in order to overcome his resistance and eliminate him as a threat.

(3) To kill your opponent immediately by applying enough pressure to certain parts of his body.

b. Properly executed, any strangle hold can cause unconsciousness in approximately 2 or 3 minutes. Continued pressure will kill a man in less than 4 minutes. Caution must be used in training: holds are applied with some pressure to assure understanding of the power involved, yet not enough pressure to cause damage.

127. Front Strangle Hold

a. *Objective and Use.* The objective is to encircle your opponent's head with your arm and strangle him. The front strangle hold is particularly good against a low frontal attack.

b. *Description.*

(1) As your opponent charges, strike his right shoulder with your left hand to slow his momentum and slip your right forearm under his throat and clamp his head under your right arm.

Clasp your left wrist with your right hand. Apply pressure by leaning backward and lifting with your right forearm. You can choke your opponent in this position (①, fig. 85).

(2) Another method of executing this hold, and one which acts more swiftly, is to grab the knife edge of your right hand with the fingers of your left hand (②, fig. 85). Pull forcefully toward your chest and, at the same time, lean backward. When applying this hold, keep the bony, inside edge of your forearm across your opponent's Adam's apple for maximum effectiveness.

c. *Followup or Recovery.* No followup is necessary if you maintain your hold. If your opponent twists out of your grasp you must apply followup action as appropriate.

d. *Instruction and Commands.* The front strangle hold is taught in three phases:

(1) FRONT STRANGLE HOLD, PHASE ONE, MOVE; on this command slow his momentum.

(2) PHASE TWO, MOVE; on this command clamp your arm around your opponent's head.

(3) PHASE THREE, MOVE; on this command apply pressure by leaning backward and lifting. At normal speed the command is FRONT STRANGLE HOLD, MOVE.

128. Side Collar Strangle Hold

a. *Objective and Use.* The objective of the side

collar strangle hold is to strangle your opponent utilizing his collar as hand holds. This hold is used best when your opponent is on the ground and unable to attack your groin. It causes unconsciousness and eventual death by stopping the flow of air to the lungs.

b. Description. Grip your opponent well back on his collar with both hands, palms out (fig. 86). Use his collar for leverage and place the second knuckle of your forefingers behind the Adam's apple at the sides of his neck. Place both your thumbs below his Adam's apple, applying continuous pressure inward by straightening the elbows and wrist.

c. Followup or Recovery. If you maintain your hold no followup is necessary. Should your opponent break your hold you must apply followup action as appropriate.

d. Instruction and Commands. The side collar strangle hold is taught in two phases:

(1) SIDE COLLAR STRANGLE HOLD, PHASE ONE, MOVE; on this command grip your opponent's collar and place the knuckles of the forefinger as prescribed.

(2) PHASE TWO, MOVE; on this command place the thumbs and apply pressure. At normal speed the command is SIDE COLLAR STRANGLE HOLD, MOVE.

129. Cross Collar Strangle Hold

a. Objective and Use. The objective is to strangle your opponent. To be effective, this hold must be executed on an opponent who has an open collar or lapels on his coat or jacket.

b. Description.

(1) Cross your hands at the wrists and grab the collar openings with your fingers on the inside and your thumbs on the outside (fig. 87). Pull with your fingers and scissor your hands against your opponent's throat. He will drop to the ground unconscious if the hold is executed properly.

(2) This strangle hold also can be executed from the rear. Cross your arms in front of your opponent's throat, seize his clothing at the neck, and pull your hands in opposite directions.

c. Followup or Recovery. If you maintain your hold no followup is necessary. Should your opponent break your hold a knee lift to the groin or a takedown should be used as appropriate.

d. Instruction and Commands. This hold is taught in two phases:

(1) CROSS COLLAR STRANGLE HOLD, PHASE ONE, MOVE; on this command cross your hands and grasp his collar as prescribed.

(2) PHASE TWO, MOVE; on this command pull with fingers and press your hands across your opponent's throat. At normal speed the command is CROSS COLLAR STRANGLE HOLD, MOVE.

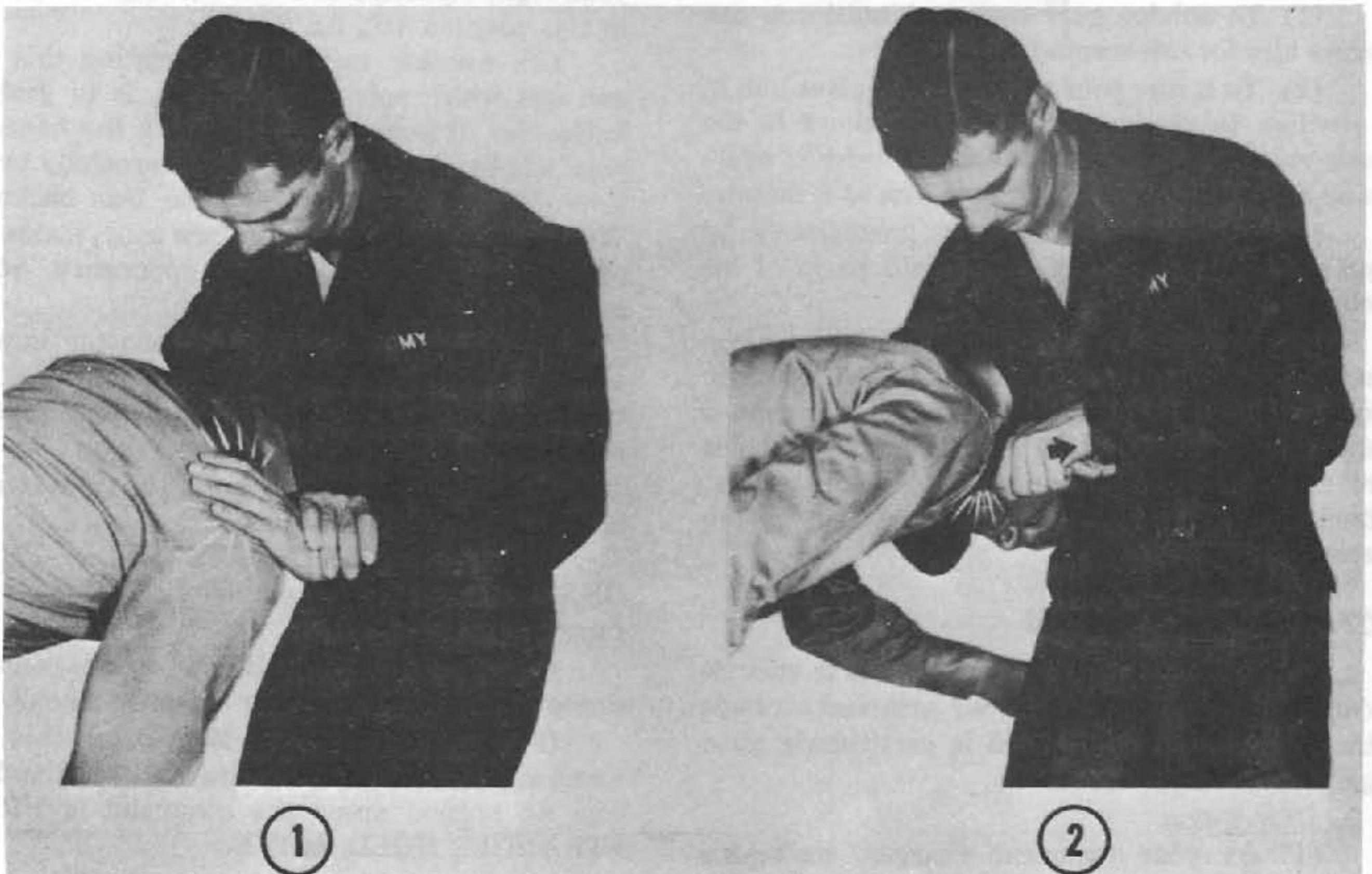

Figure 85. Front strangle hold.

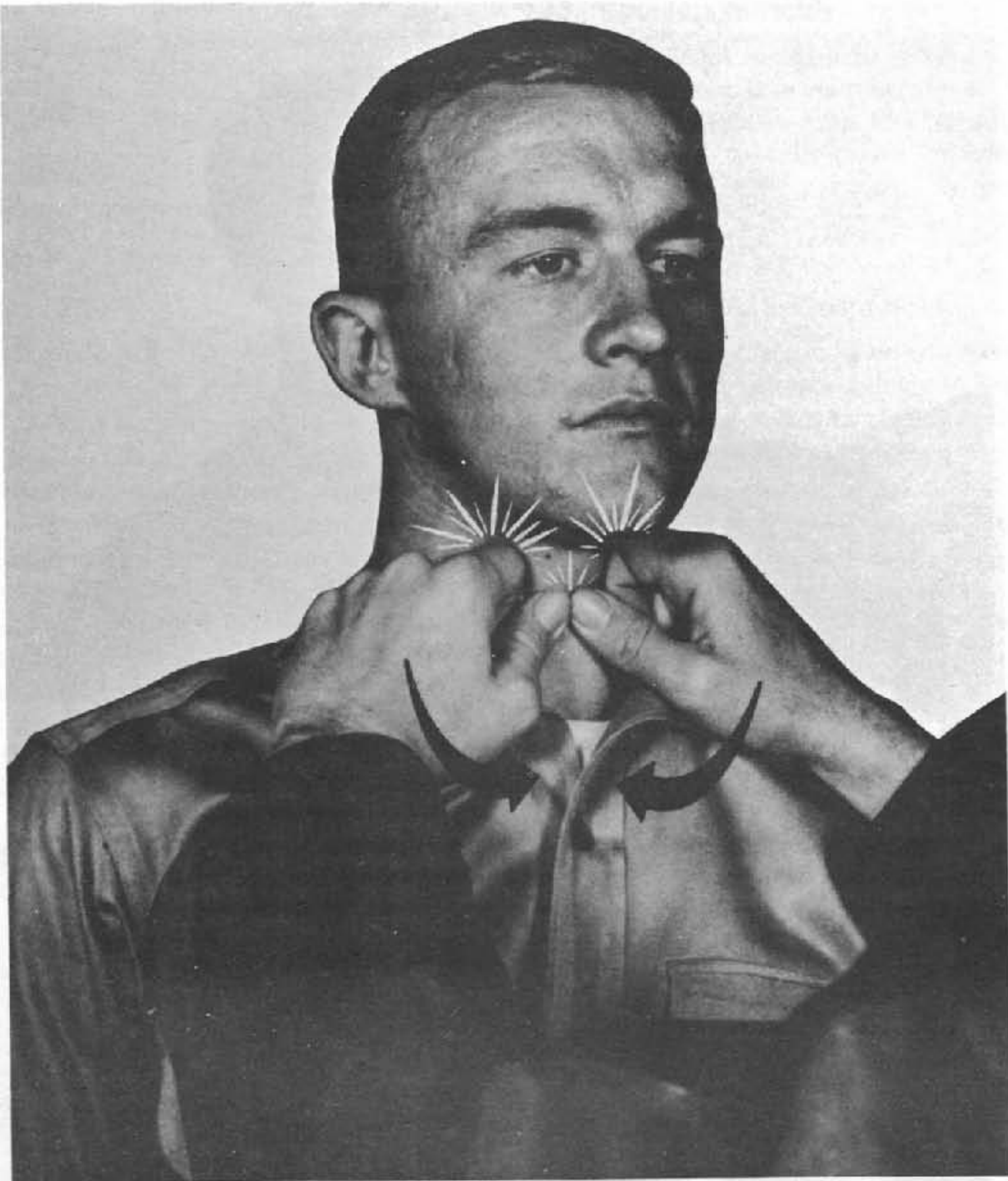

Figure 86. Side collar strangle hold.

130. Full Nelson

a. Objective and Use. The objective of this hold is to force your opponent to the defensive and subdue him. It is used best when you gain a position to his rear.

b. Description.

(1) Execute this hold from the rear. Place both arms well up into your opponent's armpits and place your hands on the back of his head. Interlock your fingers (①, fig. 88).

(2) Apply downward pressure on the back of his head and upward pressure under his arms (②, fig. 88). This should subdue him.

c. Followup or Recovery. If your opponent should slip out of the hold he probably will turn to face you, follow up with a kick.

d. Instruction and Commands. The full nelson is taught in two phases:

(1) FULL NELSON, PHASE ONE, MOVE; on this command (from the rear of your opponent) place your arms up into his armpits and your hands on the back of his head.

(2) PHASE TWO, MOVE; on this command apply pressure downward on his head and upward under his arms. At normal speed the command is FULL NELSON, MOVE.

131. Hammerlock

a. Objective and Use. The objective of this hold is to place your opponent's arm in a painful position in order to subdue him. It is used best when you can catch his arm at the wrist and pull it to his rear.

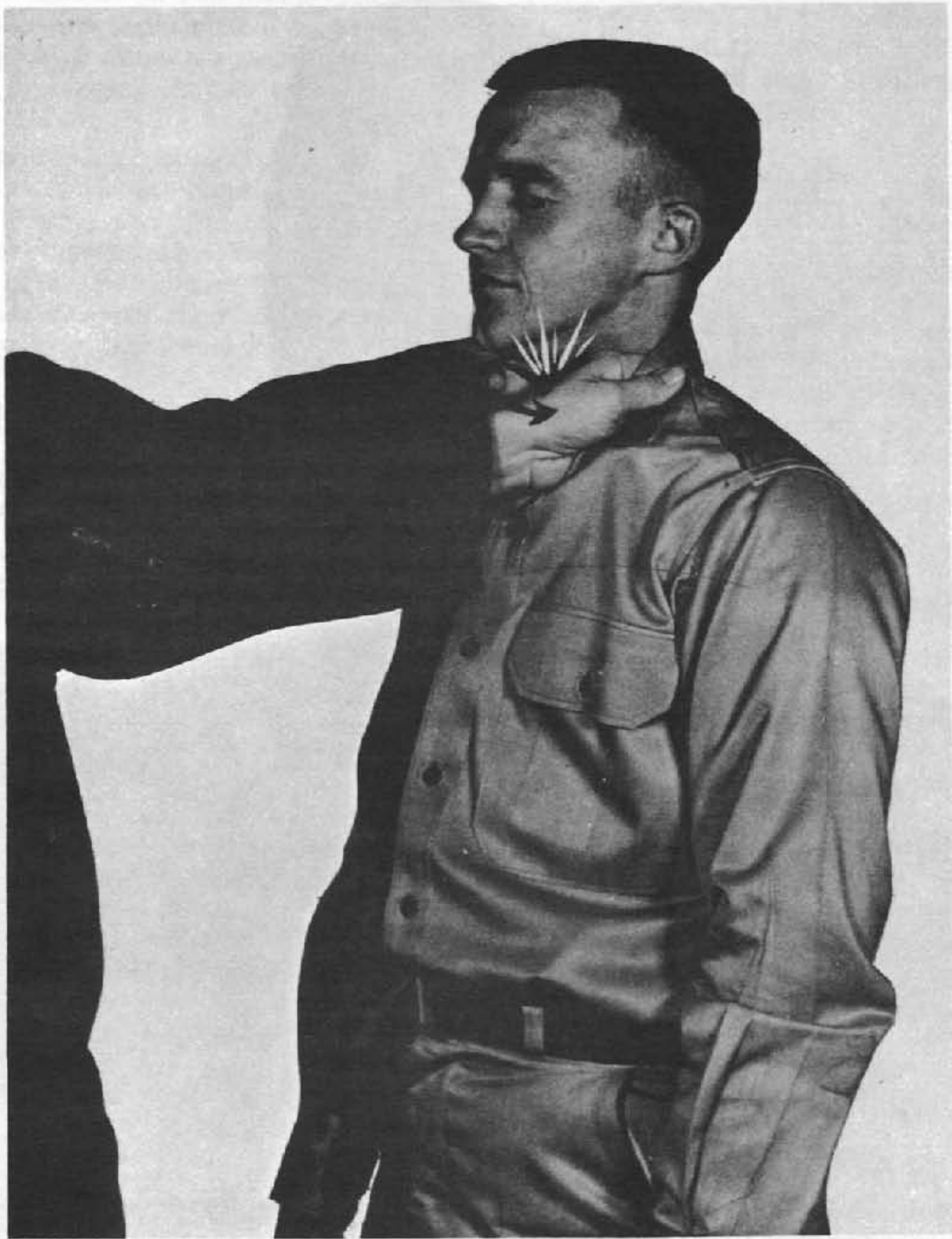

Figure 87. Cross collar strangle hold.

b. Description.

(1) To execute the hammerlock from the rear, grab your opponent's hand or wrist and pull backward. Then force his forearm up toward his head. By keeping your right hand at his right elbow and continuing to force his arm up, you can dislocate his shoulder (fig. 89).

(2) To execute the hammerlock when facing your opponent, grab his right wrist with both hands. Pivot to your left 180°. During the pivot, raise your opponent's arm above your head and step beneath it and behind him at the completion of your turn.

c. Followup or Recovery. If you should lose your

hold on your opponent's wrist follow up with a blow to a vulnerable area or a kick as appropriate.

d. Instruction and Command. The hammerlock is taught in one movement. The command is HAMMERLOCK, MOVE.

132. Double Wristlock

a. Objective and Use. The objective of the double wristlock is to immobilize your opponent's arm and put pressure on his elbow joint. It is used best when your opponent is to your rear and in the act of reaching around your waist.

b. Description.

(1) To execute a double wristlock, grab your

opponent's right wrist with your left hand (①, fig. 90). Pass your right hand and arm over his right upper arm, under his bent elbow, and clasp your left wrist, completing the double wristlock (②, fig. 90).

(2) You can continue into a twisting hammerlock by jerking his arm up and back (③, fig. 90).

(3) Step 4, figure 90, illustrates a variation of the double wristlock.

c. Followup or Recovery. If you cannot complete the hold, or your opponent withdraws his arm, drive your elbow to his ribs or strike him in the groin.

d. Instruction and Commands. The double wristlock is taught in two phases:

(1) **DOUBLE WRISTLOCK, PHASE ONE, MOVE;** on this command grasp your opponent's wrist with your left hand.

(2) **PHASE TWO, MOVE;** on this command pass your right hand and arm over his upper arm, under his bent elbow, and clasp your left wrist. At normal speed the command is **DOUBLE WRISTLOCK, MOVE.**

133. Counters to Holds

If your opponent succeeds in getting a hold on you, you must break the hold before or immediately after he completes it. Bite, kick, or hit him at vulnerable points to help loosen or break the hold before he can apply pressure. By escaping from your opponent's grasp immediately, you can take the offense and attack him.

134. Counters to a Choke Hold

a. Objective and Use. Your objective in countering a choke hold is to act quickly to break the hold. Use of this counter works best if your opponent's arms are extended.

b. Description.

(1) When your opponent attempts to choke you, use a roundhouse arm swing to break his hold (①, fig. 91).

(2) As you swing your arm over his arms pivot in the direction of your swing to get as much of your body weight as possible behind your arm swing (②, fig. 91). This causes your opponent to loosen his hold.

(3) This escape also can be used against a



Figure 88. Full Nelson.

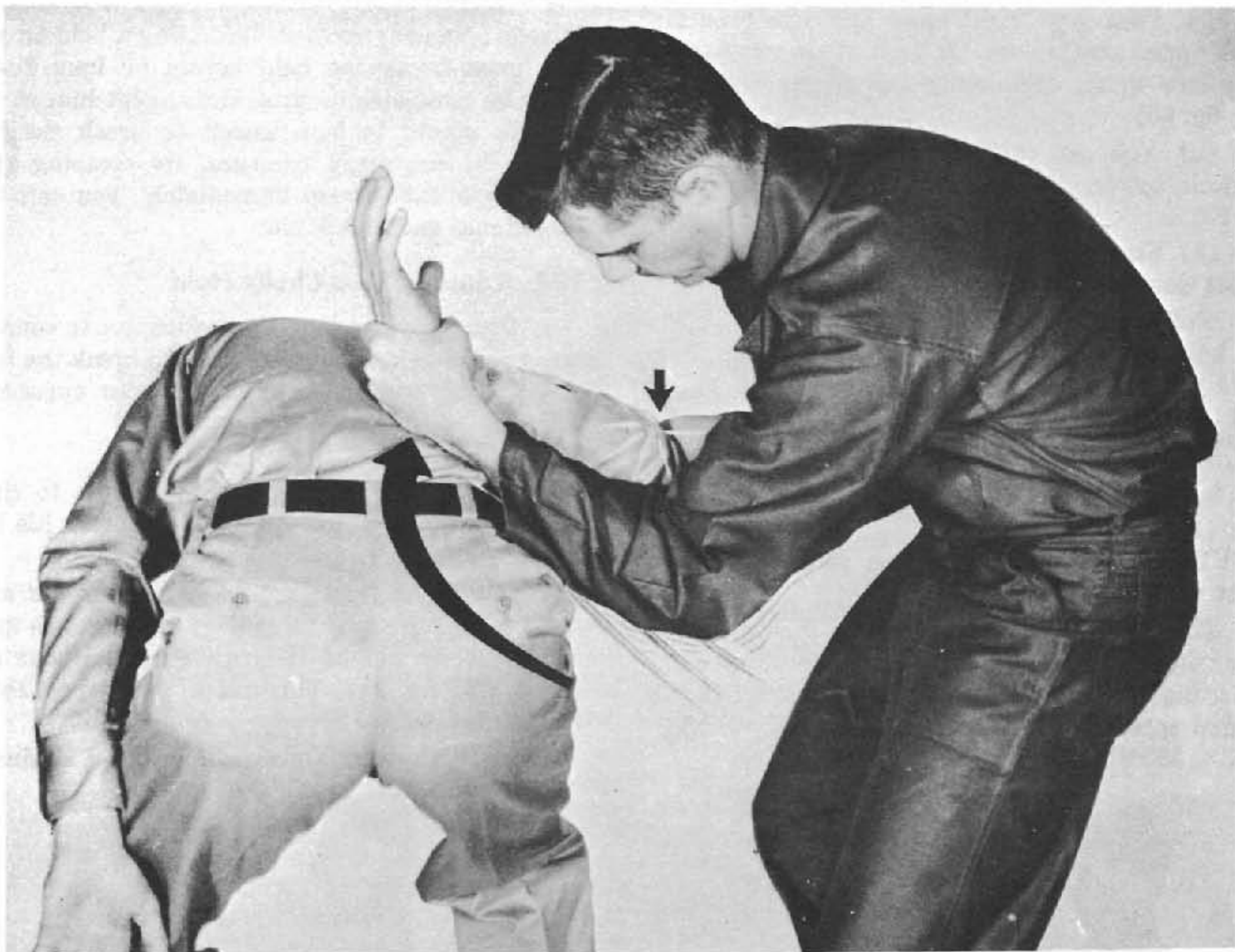

Figure 89. Hammerlock.

choke hold from the rear. Swing your arm and pivot around facing your opponent as you swing.

c. Followup or Recovery. Be prepared to strike him in the face or neck with a backward, knife edge blow of your hand before he recovers.

d. Instruction and Command. This choke hold counter is taught in one phase. The command is COUNTER TO (FRONT or REAR) CHOKE HOLD, MOVE.

135. Throw Counter to a Front Hold, Arms Pinned

a. Objective and Use. The objective of this counter is to break your opponent's hold and throw him to the ground. The use of this counter is when your opponent has applied a close hold from the front and has pinned your arms.

b. Description.

(1) To escape an opponent who has grabbed you around the body and pinned your arms in a front overarm bear hug (①, fig. 92), force your hips to the rear leaving a space between your bodies. Then grab or strike into his groin (②, fig. 92).

(2) Pivoting on your left foot, place your right foot outside of your opponent's right foot. Slip your right arm under his left armpit and grab him across the back. With your left hand grab his right upper arm, pulling it forcefully. Drive your buttocks into his midsection and at the same time twist to your left. Lift with your right arm and pull with your left hand, throwing your opponent over your hip and to the ground (③, fig. 92).

c. Followup or Recovery. As your opponent strikes the ground, followup with a blow to a vulnerable point.

d. Instruction and Commands. This counter to a front hold, arms pinned, is taught in three phases:

(1) THROW COUNTER TO A FRONT HOLD, ARMS PINNED, PHASE ONE, MOVE; on this command force your hips to the rear and attack his groin.

(2) PHASE TWO, MOVE; on this command, pivot, move your right foot outside your opponent's right foot, slip your right arm under his left arm and around his back and grasp his right arm pulling down forcefully.

(3) PHASE THREE, MOVE; on this com-



①



②



③



④

Figure 90. Double wristlock.

mand drive your buttocks into his midsection and twist to your left, lift and pull him over your hip to the ground. At normal speed the command is **THROW COUNTER TO A FRONT HOLD, ARMS PINNED, MOVE.**

136. Push-Pull Counter to Front Arms Free Hold

a. Objective and Use. The objective is to break this hold quickly. The best use is when your arms are free.

b. Description.

(1) An opponent may lock his arms around your waist and attempt to bend you over backwards with a front underarm bear hug (①, fig. 93).

(2) To counter this hold, place the thumb of your left hand under the base of your opponent's nose. Put your right arm around his waist. By pressing with your left thumb and pulling his waist toward you, he either loosens his grip or is forced backward (②, fig. 93).

c. Followup or Recovery. Followup with a knee lift to the groin or a kick.

d. Instruction and Commands. This counter is taught in two phases:

(1) **PUSH-PULL COUNTER TO FRONT HOLD, ARMS FREE, PHASE ONE, MOVE;** at this command place the left thumb under the base of your opponent's nose, and put your right arm around his waist.

(2) **PHASE TWO, MOVE;** on this command

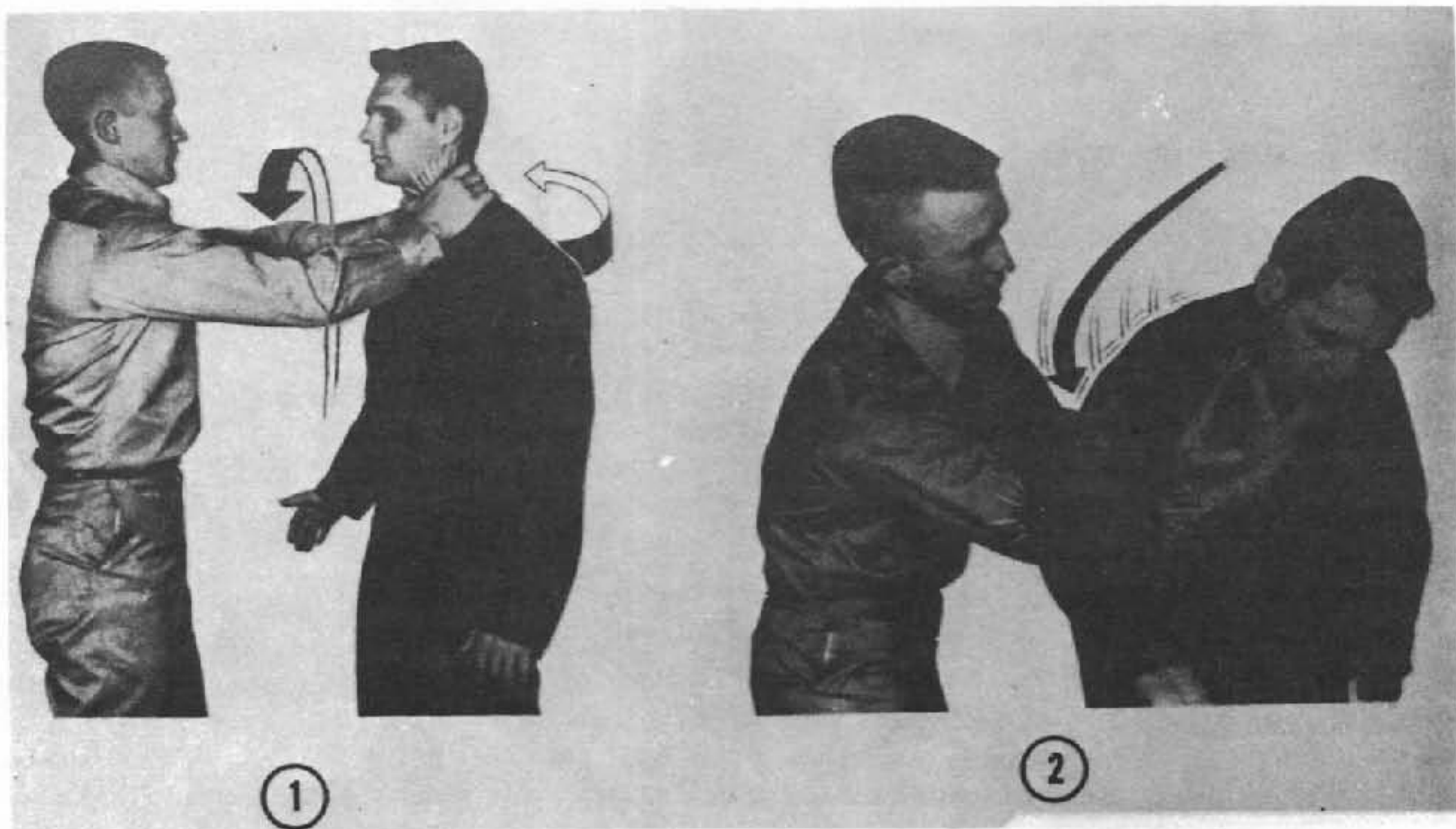

Figure 91. Counter to a choke hold.



Figure 92. Throw counter to a front hold, arms pinned.

press with your left thumb and pull his waist toward you. At normal speed the command is **PUSH-PULL COUNTER TO FRONT HOLD, ARMS FREE, MOVE.**

137. Counter to a Two-Hand Grip on One Wrist

a. Objective and Use. The objective of this counter is to break the grip on your wrist. It is used when your opponent is facing you and has grasped one of your wrists with both hands.

b. Description.

(1) Your opponent may grab you with a two-hand grip on one wrist (①, fig. 94).

(2) To counter it, step forward with your right foot and bend both knees. Keeping the trunk of the body upright, bring your right elbows close to your stomach and reach across with your left hand and grab your right fist (②, fig. 94).

(3) By straightening your legs and pulling back with the power of your body and arms, you bring pressure on your opponent's thumbs, forcing him to release his hold. At the completion of the



Figure 93. Push-pull counter to front hold, arms free.

counter, you are in position to deliver a followup blow (③, fig. 94).

c. *Followup or Recovery.* Deliver a blow to your opponent's head or neck with the knife edge of your right hand.

d. *Instruction and Commands.* This counter is taught in two phases:

(1) COUNTER TO TWO-HAND GRIP ON ONE WRIST, PHASE ONE, MOVE; on this command step forward with your right foot, bend both knees, reach across with left hand and grasp the right fist.

(2) PHASE TWO, MOVE; on this command straighten your legs, pull back with the body and legs to break the hold. At normal speed the command is COUNTER TO TWO-HAND GRIP ON ONE WRIST, MOVE.

138. Counter to an Overhand Grip on Both Wrists

a. *Objective and Use.* The objective of this counter is to break your opponent's hold on both your wrists. This counter can be used only when this hold is applied with your opponent facing you.

b. *Description.*

(1) Your opponent may grab you with an overhand grip on both wrists (①, fig. 95).

(2) To counter it, step forward with either foot and bend both knees. At the same time, bend your arms so the elbows are close to your lower abdomen. Pull your opponent forward and downward (②, fig. 95).

(3) Execute the counter by straightening your legs, pulling back with your body, and pushing your arms upward in one motion. Speed is important if the counter movement is to be effective (③, fig. 95).

c. *Followup or Recovery.* Follow up by driving both of your raised hands forcefully downward on the junction of your opponent's head and shoulders.

d. *Instructions and Commands.* This counter is taught in two phases:

(1) COUNTER TO OVERHAND GRIP ON BOTH WRISTS, PHASE ONE, MOVE; on this command step forward with either foot, bend both knees and at the same time bend your arms. This will pull your opponent forward and downward.

(2) PHASE TWO, MOVE; on this command straighten your legs, arch your back and push your arms upward. At normal speed the command is

COUNTER TO OVERHAND GRIP ON BOTH WRISTS, MOVE.

139. Overhead Counter to Rear Body Hold, Arms Pinned

a. Objective and Use. The objective is to get your opponent off your back and break the hold by throwing him to the ground. This counter is used best when your opponent has a close hold from the rear with your arms pinned.

b. Description.

(1) Your opponent may grab you around the body and pin both your arms in a rear overarm body hold (①, fig. 96).

(2) Loosen his grip by stomping on his instep or kicking him on the shin. Raise your elbows shoulder high and at the same time lower your body quickly by bending your knees (②, fig. 96).

(3) Turning your body slightly to the right, drive your elbow forcefully into your opponent's side or midsection so he will release his grip (③, fig. 96).

(4) Continue the movement by reaching up with your right hand and grabbing his right upper arm just above his elbow. Grip his right wrist with your left hand and throw him over your head (④, fig. 96).

c. Followup or Recovery. Your opponent is at your feet upon completion of the counter. Followup by stomping or kicking his head or other vital area.

d. Instruction and Commands. This counter is taught in three phases:

(1) OVERHEAD COUNTER TO REAR BODY HOLD, ARMS PINNED, PHASE ONE, MOVE; on this command stomp opponent's instep

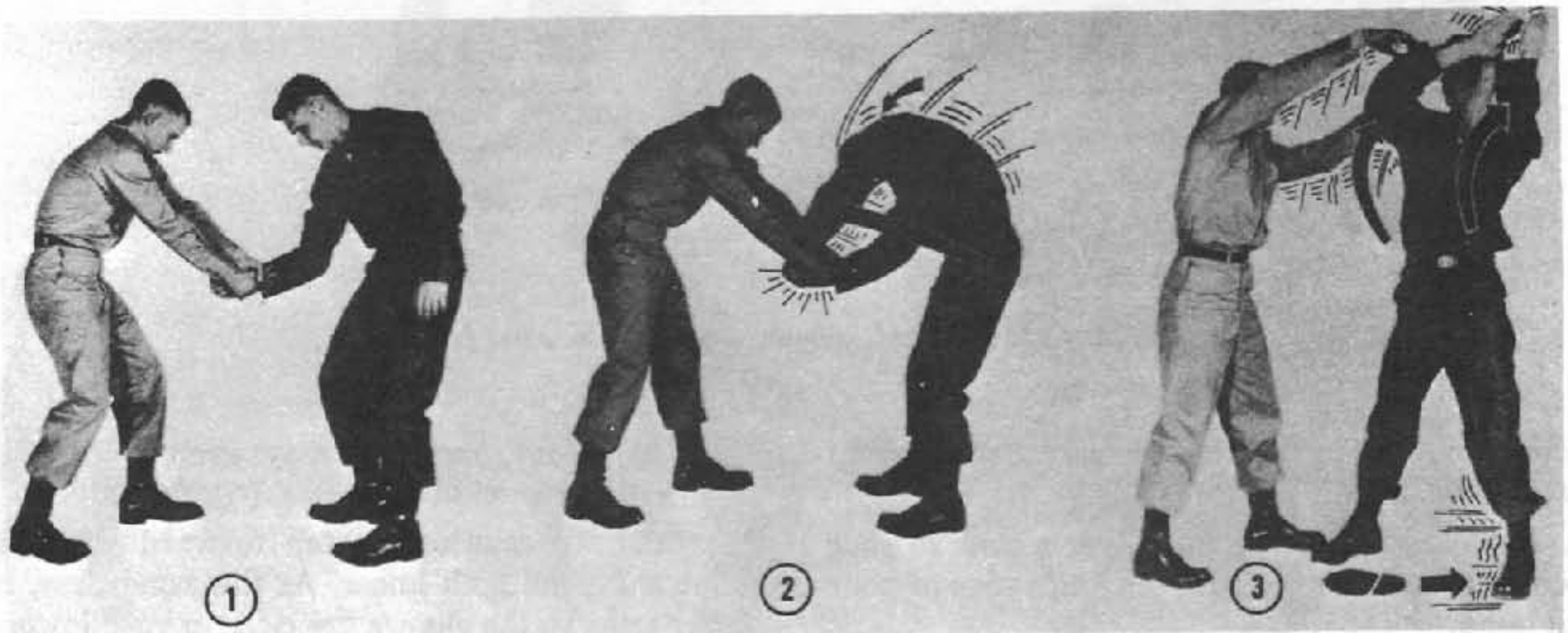

Figure 94. Counter to a two-hand grip on one wrist.

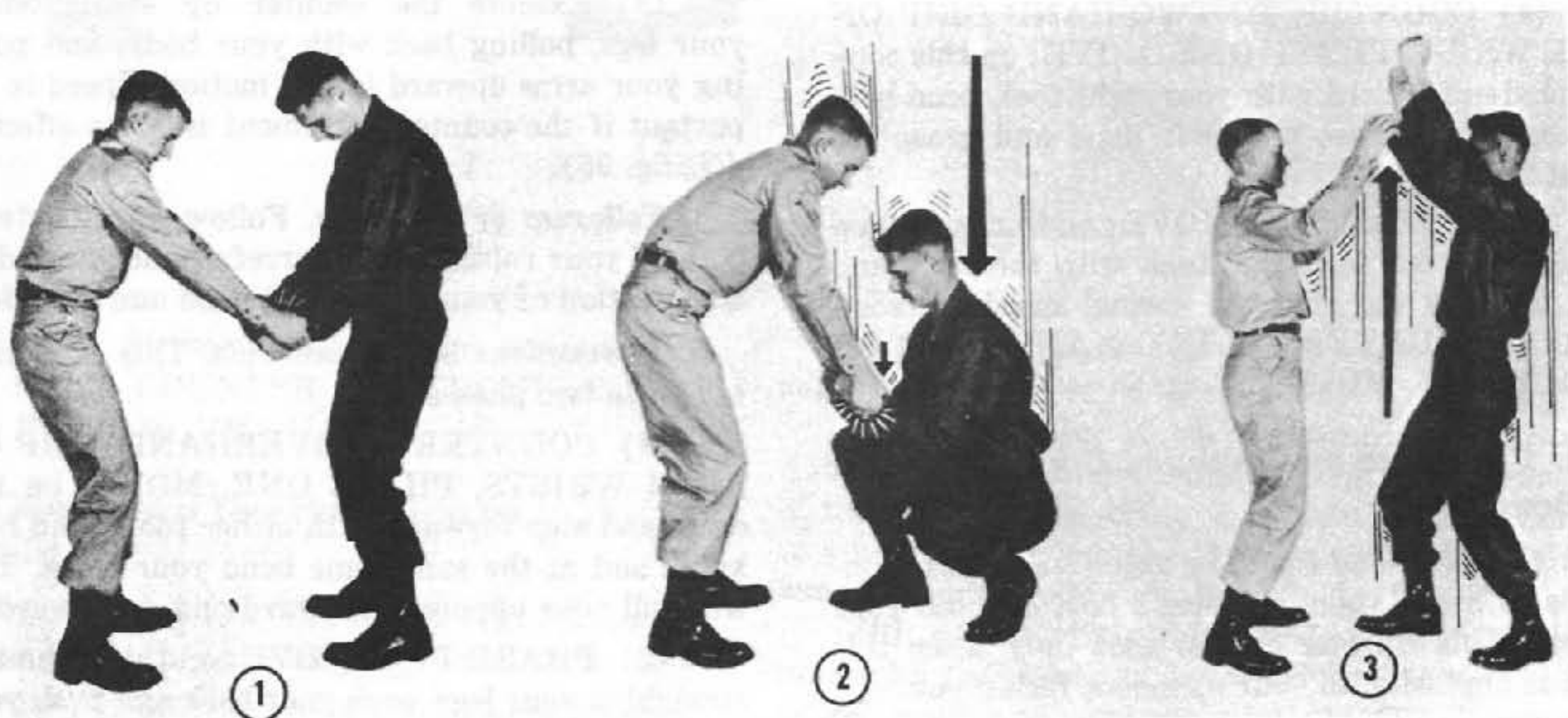

Figure 95. Counter to an overhand grip on both wrists.

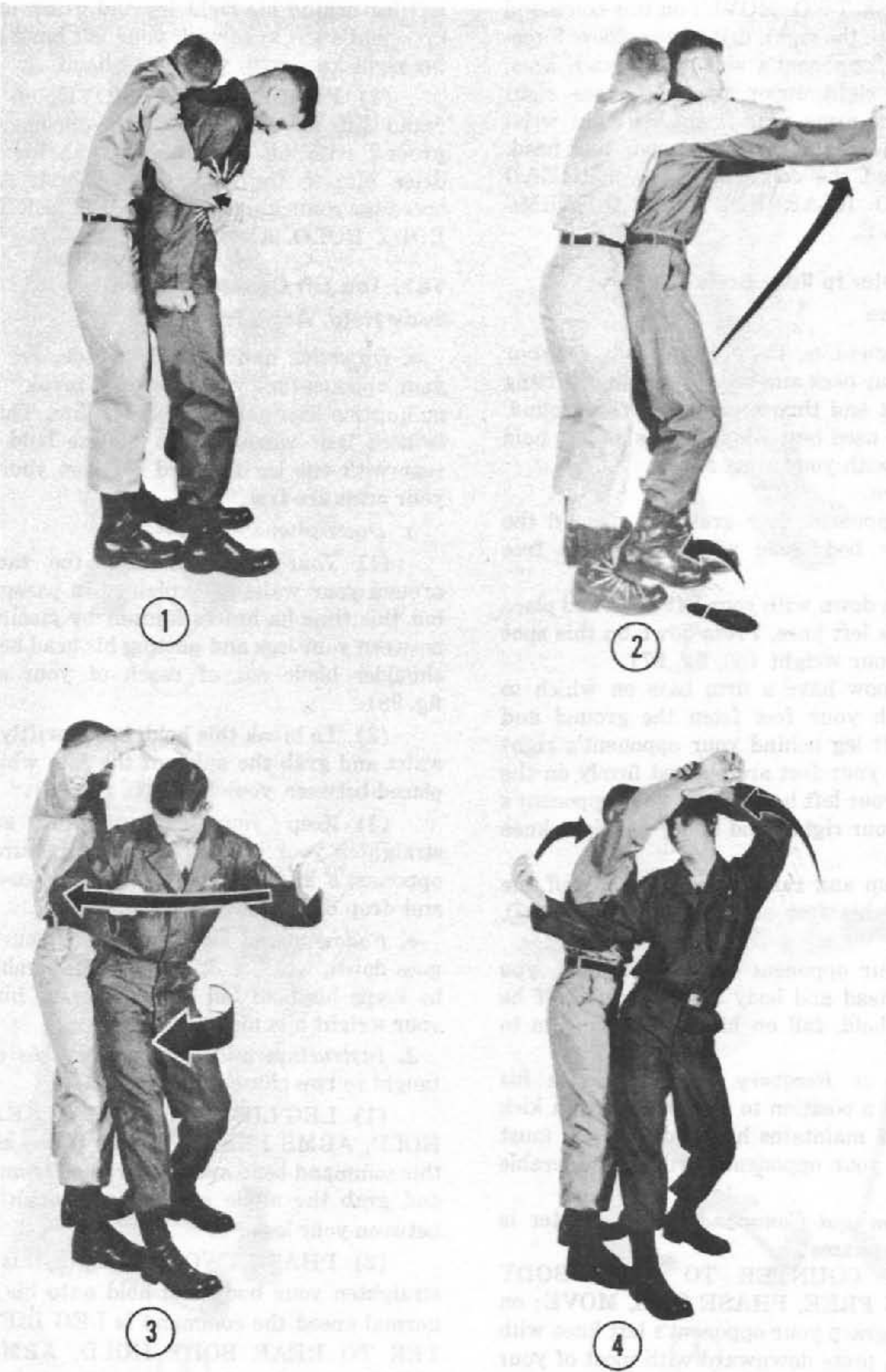

Figure 96. Overhead counter to rear body hold, arms pinned.

or kick his shin, raise your shoulders high, and follow by bending your knees.

(2) PHASE TWO, MOVE; on this command turn your body to the right, drive your elbow forcefully into your opponent's side or stomach area, then grasp his right upper arm with your right hand, and at the same time grasp his right wrist with your left hand and throw him over your head. At normal speed the command is OVERHEAD COUNTER TO REAR BODY HOLD, ARMS PINNED, MOVE.

140. Lift Counter to Rear Body Hold, Arms Free

a. *Objective and Use.* The objective is to get your opponent off your back and break his hold by lifting him off his feet and throwing him to the ground. This counter is used best when he has a close hold from the rear with your arms free.

b. *Description.*

(1) An opponent may grab you around the body in a rear body hold with your arms free (①, fig. 97).

(2) Reach down with your left hand and place it just above his left knee. Press down on this spot with most of your weight (②, fig. 97).

(3) You now have a firm base on which to pivot. Lift both your feet from the ground and switch your left leg behind your opponent's right leg. As soon as your feet are planted firmly on the ground, bring your left hand under your opponent's left knee and your right hand under his right knee (③, fig. 97).

(4) Lift up and raise your opponent off the ground, lifting his feet as high as possible (④, fig. 97).

(5) If your opponent releases his hold, you can drive his head and body to the ground. If he maintains his hold, fall on him and force him to the ground.

c. *Followup or Recovery.* If he releases his hold you are in a position to follow up with a kick or stomp; if he maintains his hold and you must go down with your opponent, strike a vulnerable area.

d. *Instruction and Commands.* This counter is taught in three phases:

(1) LIFT COUNTER TO REAR BODY HOLD, ARMS FREE, PHASE ONE, MOVE; on this command grasp your opponent's left knee with your left hand, press downward with most of your weight.

(2) PHASE TWO, MOVE; on this command pivot by lifting both your feet and switch your left leg behind his right leg and grasp under your opponent's left knee with your left hand and under his right knee with your right hand.

(3) PHASE THREE, MOVE; on this command lift up and raise your opponent off the ground with his feet higher than his head and drive him to the ground head first. At normal speed the command is LIFT COUNTER TO REAR BODY HOLD, ARMS FREE, MOVE.

141. Leg Lift Counter to Rear Body Hold, Arms Free

a. *Objective and Use.* The objective is to get your opponent off your back and break his hold by pulling his legs out from under him. This counter is used best when he has a close hold from the rear with one leg forward between your legs and your arms are free.

b. *Description.*

(1) Your opponent uses the same grasp around your waist as explained in paragraph 112, but this time he braces himself by placing one leg between your legs and putting his head behind your shoulder blade out of reach of your arms (①, fig. 98).

(2) To break this hold, bend swiftly from the waist and grab the ankle of the foot which he has placed between your legs (②, fig. 98).

(3) Keep your hold on his ankle and straighten your body. This puts pressure on your opponent's knee, causing him to release his hold and drop on his back (③, fig. 98).

c. *Followup and Recovery.* When your opponent goes down, whirl and kick at a vulnerable spot. If he keeps his hold fall back on top of him so that your weight hits his midsection.

d. *Instruction and Commands.* This counter is taught in two phases:

(1) LEG LIFT COUNTER TO REAR BODY HOLD, ARMS FREE, PHASE ONE, MOVE; on this command bend swiftly forward from the waist and grab the ankle of the foot which he placed between your legs.

(2) PHASE TWO, MOVE; on this command straighten your body and hold onto his ankle. At normal speed the command is LEG LIFT COUNTER TO REAR BODY HOLD, ARMS FREE, MOVE.

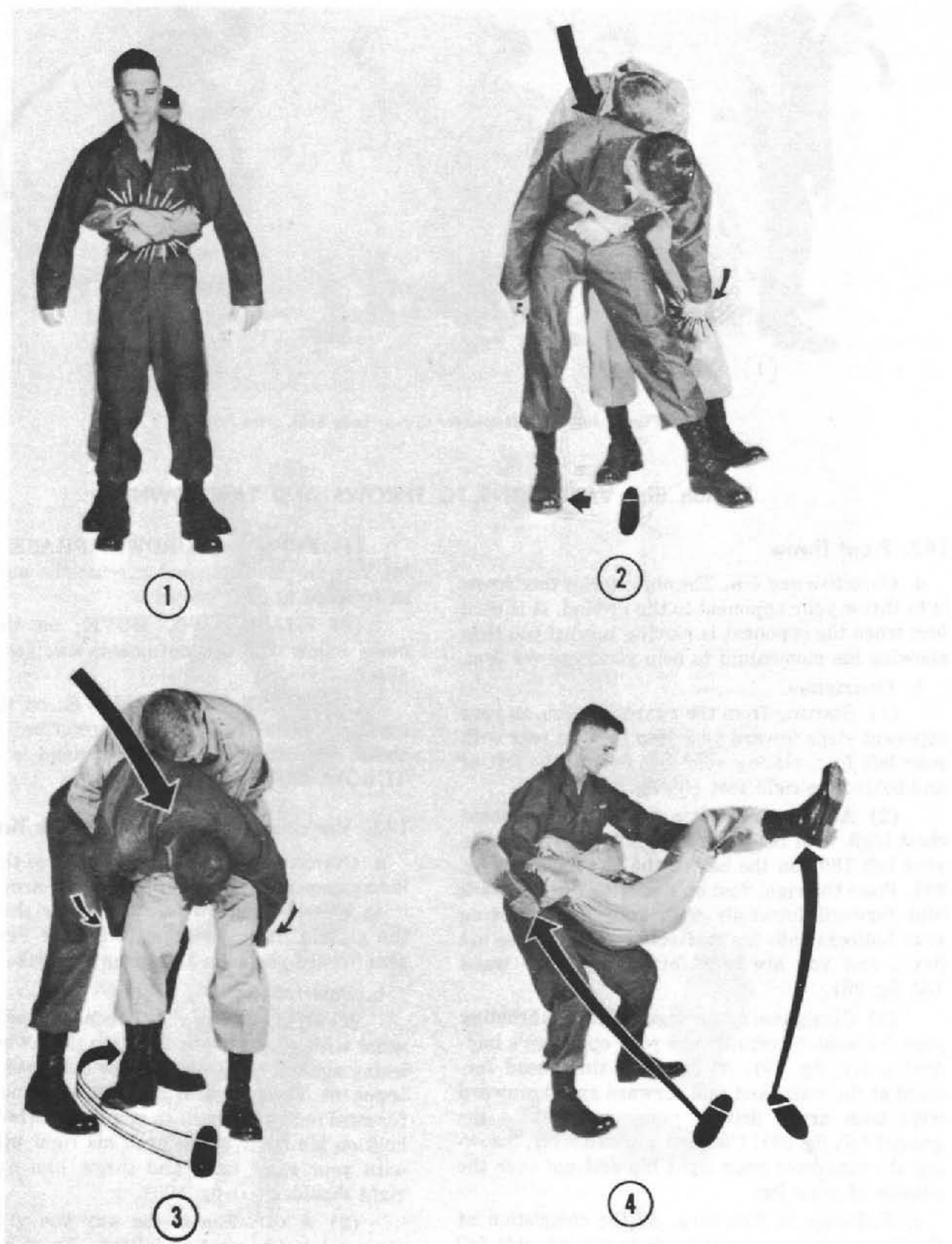

Figure 97. Lift counter to rear body holds, arms free.

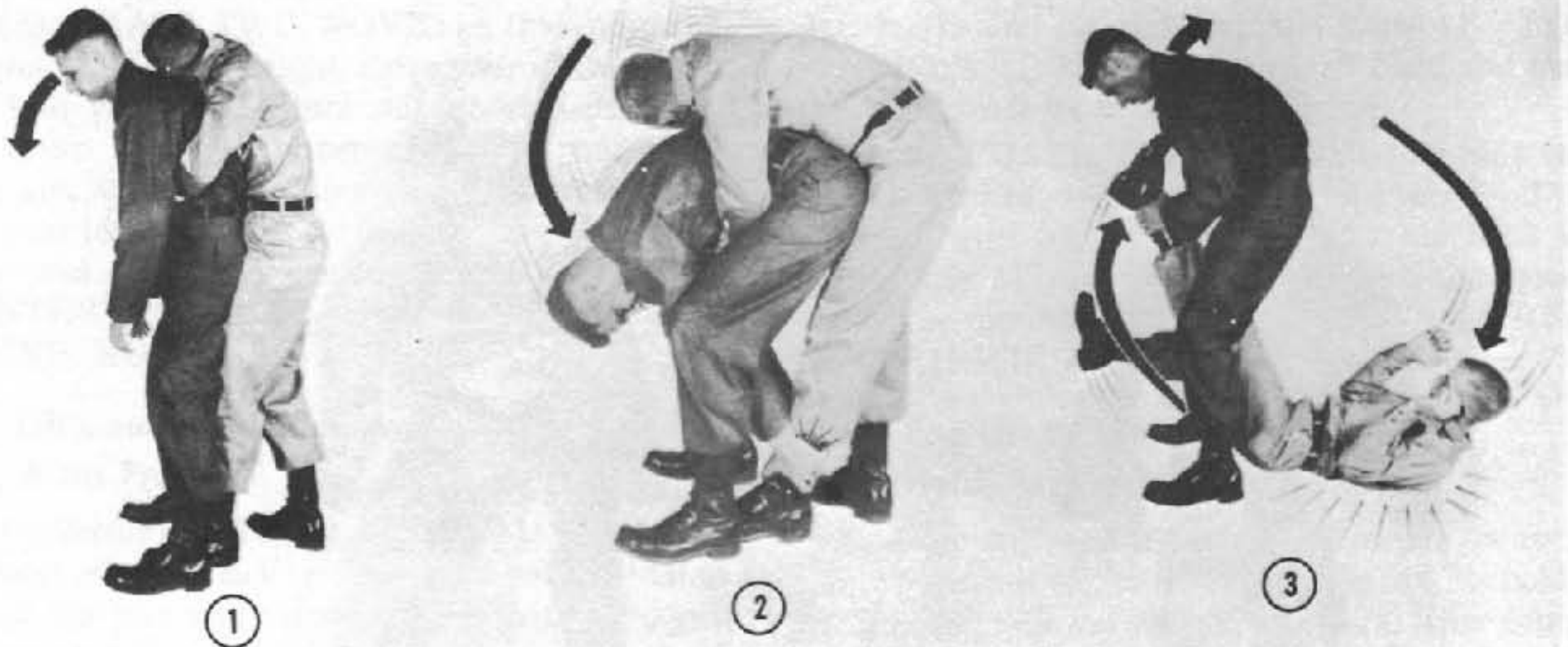

Figure 98. Leg lift counter to rear body hold, arms free.

Section III. VARIATIONS TO THROWS AND TAKEDOWNS

142. Front Throw

a. Objective and Use. The objective of this throw is to throw your opponent to the ground. It is used best when the opponent is moving toward you thus allowing his momentum to help you to throw him.

b. Description.

(1) Starting from the guard position, as your opponent steps toward you, step to your rear with your left foot, placing your left foot to the left of and behind the right foot (①, fig. 99).

(2) At the same time grab your opponent chest high with both hands (②, fig. 99). Pivot to your left 180° on the ball of the left foot (③, fig. 99). Place the right foot on line with the left. Jerk him forward forcefully with both arms, driving your buttocks into his midsection. Your knees are flexed and you are bent forward at your waist (④, fig. 99).

(3) Straighten your legs quickly, thrusting your buttocks forcefully into your opponent's midsection (⑤, fig. 99). At the same time, bend forward at the waist and pull forward and downward with both arms, driving your opponent to the ground (⑥, fig. 99). Use your hip as a lever, throwing the man over your right hip and not over the outside of your leg.

c. Followup or Recovery. At the completion of the throw your opponent lands in the left side fall position. He is then in a position to receive deadly followup blows or kicks to a vulnerable part of his body.

d. Instruction and Commands. This throw is taught in three phases:

(1) FRONT THROW, PHASE ONE, MOVE; on this command execute the movements as specified in *b*(1) above.

(2) PHASE TWO, MOVE; on this command follow with the movements specifies in *b*(2) above.

(3) PHASE THREE, MOVE; on this command complete the throw as prescribed in *b*(3) above. At normal speed the command is FRONT THROW, MOVE.

143. Variations of the Overshoulder Throw

a. Objective and Use. The objective of this throw is to grasp your opponent's extended arm and use it as a lever to throw him over your shoulder to the ground. It is used best when he extends an arm toward you as in an attempt to strike or hit.

b. Description.

(1) While facing your opponent grab his right wrist with your left hand. This is done when countering against an overhead blow delivered by your opponent. Then pivot to your left 180°, pulling him forward onto your back as you turn. Retaining the hold on his right wrist, grab his right upper arm with your right hand and throw him over your right shoulder (①, fig. 100).

(2) A variation in the way you grasp your opponent can be used as follows: From a position facing your opponent grab his left lapel with your right hand. Maintain this hold and pivot 180° to the left, placing your right forearm under the right armpit as you complete the pivot. Grab his right arm at the elbow as you are executing the pivot.



①



②



③



④



⑤



⑥

Figure 99. Front throw.

Throw him over your right shoulder (②, fig. 100).

c. Followup or Recovery. Your opponent lands at your feet which places you in position to stomp his head or deliver a kick.

d. Instruction and Commands. These two variations of the overshoulder throw are taught in two phases:

(1) VARIATION OF THE OVERSHOULDER THROW, PHASE ONE, MOVE; on this command grasp the extended wrist, pivot, and pull your opponent close to you.

(2) PHASE TWO, MOVE; on this command grasp his arm with the chosen hold (either para 115b(1) or (2), and throw him over your shoulder. At normal speed the command is VARIATION OF THE OVERSHOULDER THROW (designate variation), MOVE.



b. Description.

(1) Both of your opponent's arms are pinned securely, his right arm with a single elbow lock and his left arm clasped at the elbow (①, fig. 101).

(2) You grab your opponent's right arm with both hands and use your hip as a lever (②, fig. 101).

(3) Place your right arm around your opponent's neck as you pivot, rather than around his waist. Your left hand locks your right arm in place (③, fig. 101).

c. Followup or Recovery. As in the regular hip throw your opponent lands at your feet. Use a stomp, kick, or blow as a followup.



Figure 100. Variations of the overshoulder throw.

144. Variations of the Hip Throw

a. Objective and Use. The objective is to provide various ways to grasp your opponent in making a hip throw. These variations are used best when the proper opening presents itself to you for use of a particular variation.

d. Instruction and Commands. These variations are taught by substitution of the desired variation movements into the prescribed sequence of the hip throw description (para 106).

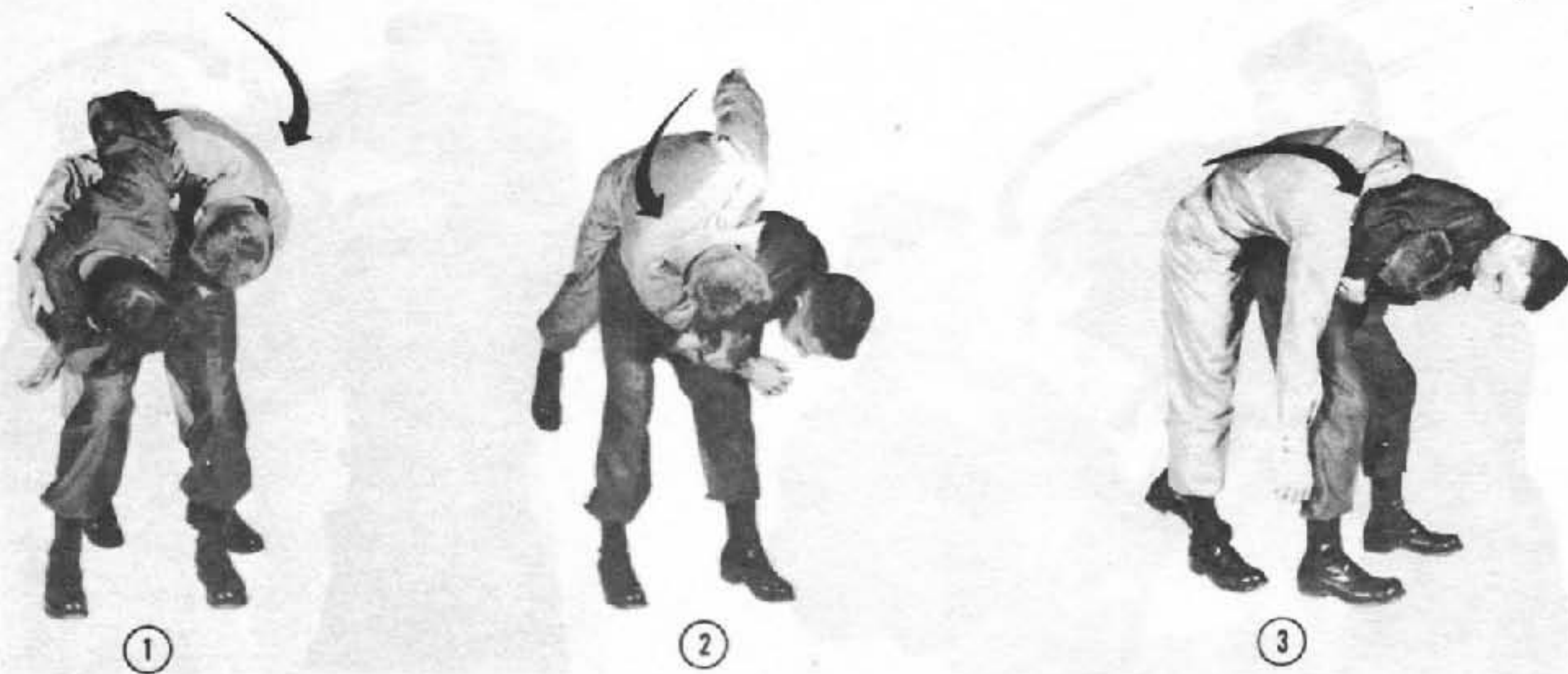

Figure 101. Variations of the hip throw.

Section IV. SENTRY SILENCING

145. General

Knowing the methods of silencing sentries will enable you to maintain surprise and to kill an unsuspecting opponent quickly and quietly from the rear.

146. Helmet Neck Break

a. Grab the front rim of your opponent's helmet with your right hand. At the same time, place your left forearm against the back of his neck and place your left hand on his right shoulder (①, fig. 102).

b. Holding firmly to the front rim of your opponent's helmet, pull his helmet up, back, and down, and drive your left forearm forward (②, fig. 102). Your left forearm, under the back edge of his helmet, acts as a lever against which his neck is broken. This method is possible only when your opponent's helmet strap is fastened underneath his chin.

147. Helmet Smash

a. If you see that your opponent's helmet strap is not fastened, or discover this when attempting the helmet neck break, silence him with a helmet smash. Snatch your opponent's helmet from his head. While doing this grab his collar or shirt with your other hand, jerking him off balance to his rear (①, fig. 103).

b. Now smash the helmet on the back of his head or his temple (②, fig. 103). Your opponent may have a chance to yell when this method is used.

148. Strangulation with Cord or Wire One-Hand Loop

a. For this method of strangulation you need a piece of flexible wire or a piece of cord about 3 feet in length, such as a bootlace. Approach your opponent from the rear holding the wire or cord ends in each hand. Toss it over his head from his left and place the heel of your left hand, still holding the end of the cord, on his shoulder near the nape of his neck (①, fig. 104).

b. At the same time, place your knee (either one) in the small of your opponent's back and yank the cord or wire with your right hand while pushing with your left hand (②, fig. 104). If this is done quickly, your opponent cannot cry out. You can tie the ends of the cord or wire around two short sticks for better handholds.

149. Strangulation with Cord or Wire, Two-Hand Loop

a. Hold the wire or cord ends in each hand. Place your left forearm across the back of your opponent's neck. Swing your right arm over your opponent's head from his right, looping the cord in front of his throat (①, fig. 105).

b. Complete the loop and jerk your arms sharply in opposite directions, tightening the loop and strangling your opponent (②, fig. 105). Quick application of this method prevents your opponent from crying out. You can cause unconsciousness or death, depending on the force used and the length of time the hold is applied.



①



②

Figure 102. Helmet neck break.



①



②

Figure 103. Helmet smash.

150. Other Methods

Other methods of silencing sentries are listed below:

a. Available Weapons.

(1) Striking an opponent on his spine with a blunt object to stun him and striking him with a sharp object to kill him (fig. 106).

(2) Use of the homemade blackjack (fig. 107).

b. Natural Weapons. Striking an opponent on

the base of the skull with the edge of your hand (①, fig. 108), or padded fist (②, fig. 108).

c. Holds.

(1) Rear takedown (fig. 109).

(2) Rear strangle hold (fig. 110).

d. Knife Attack.

(1) Thrust to the kidney (para 122a).

(2) Thrust to the side of the neck (para 122b).

(3) Throat slash (para 122c).

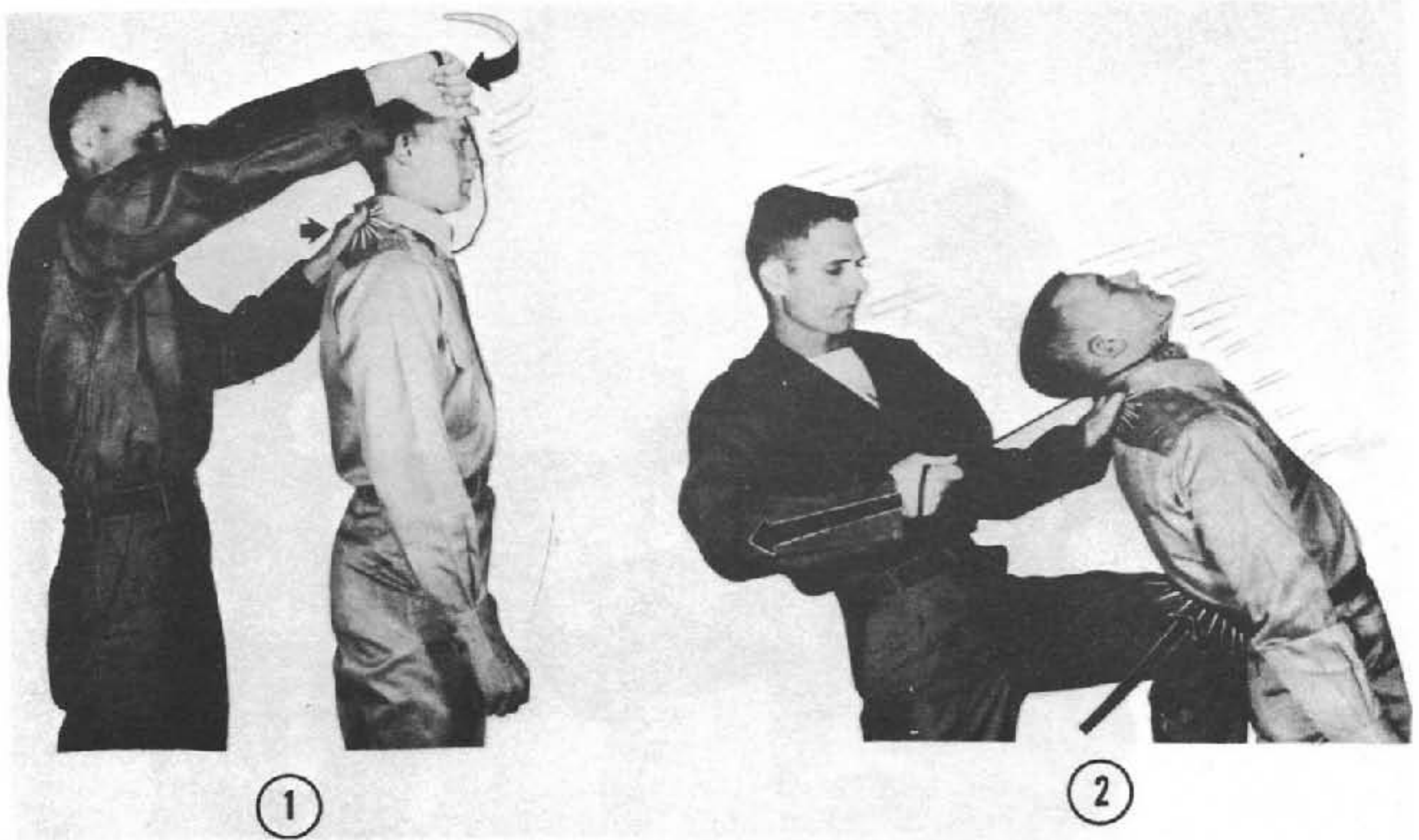

Figure 104. Strangulation with cord or wire, one-hand loop.

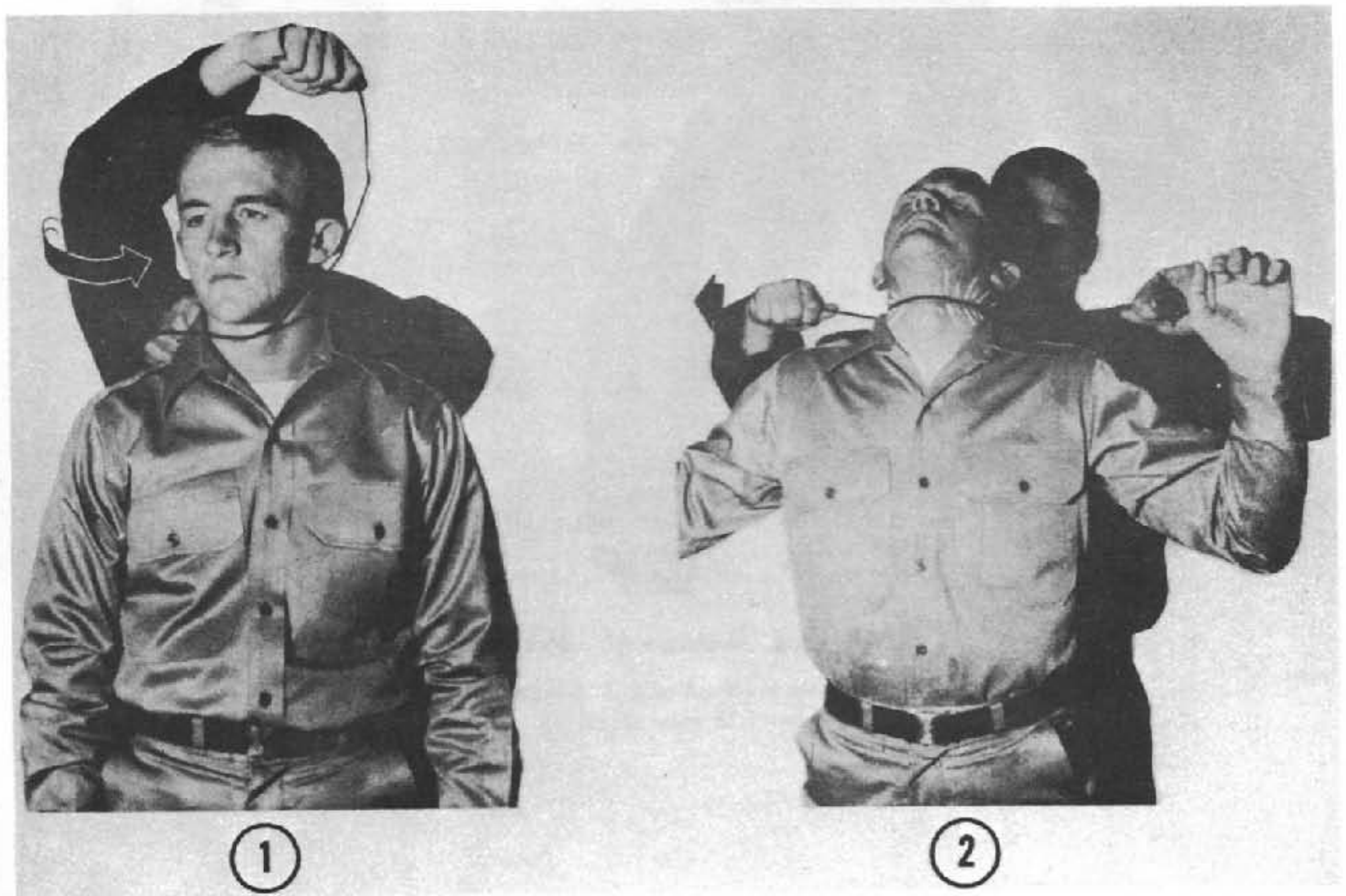

Figure 105. Strangulation with cord or wire, two-hand loop.

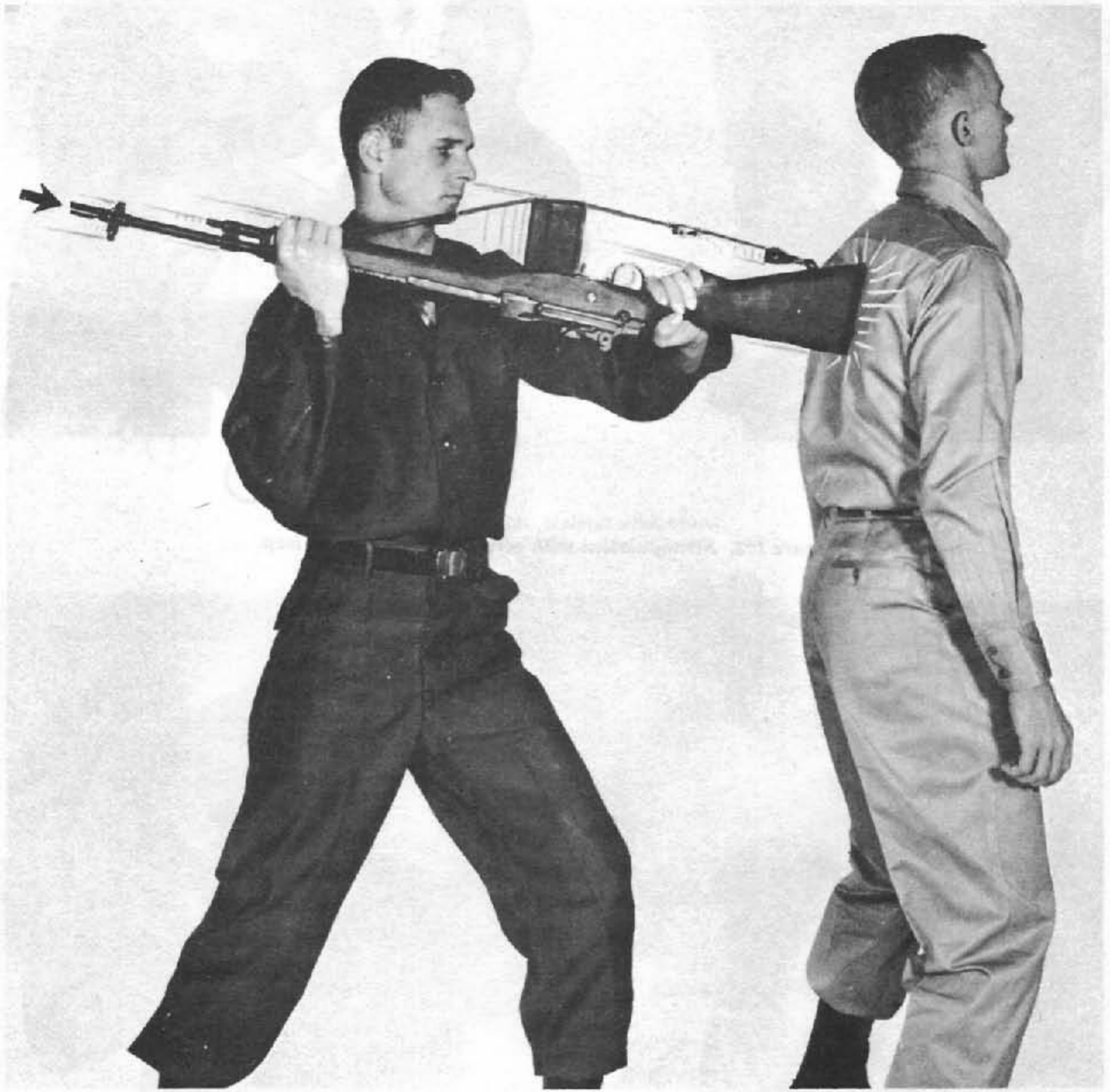

Figure 106. Striking with a blunt object.

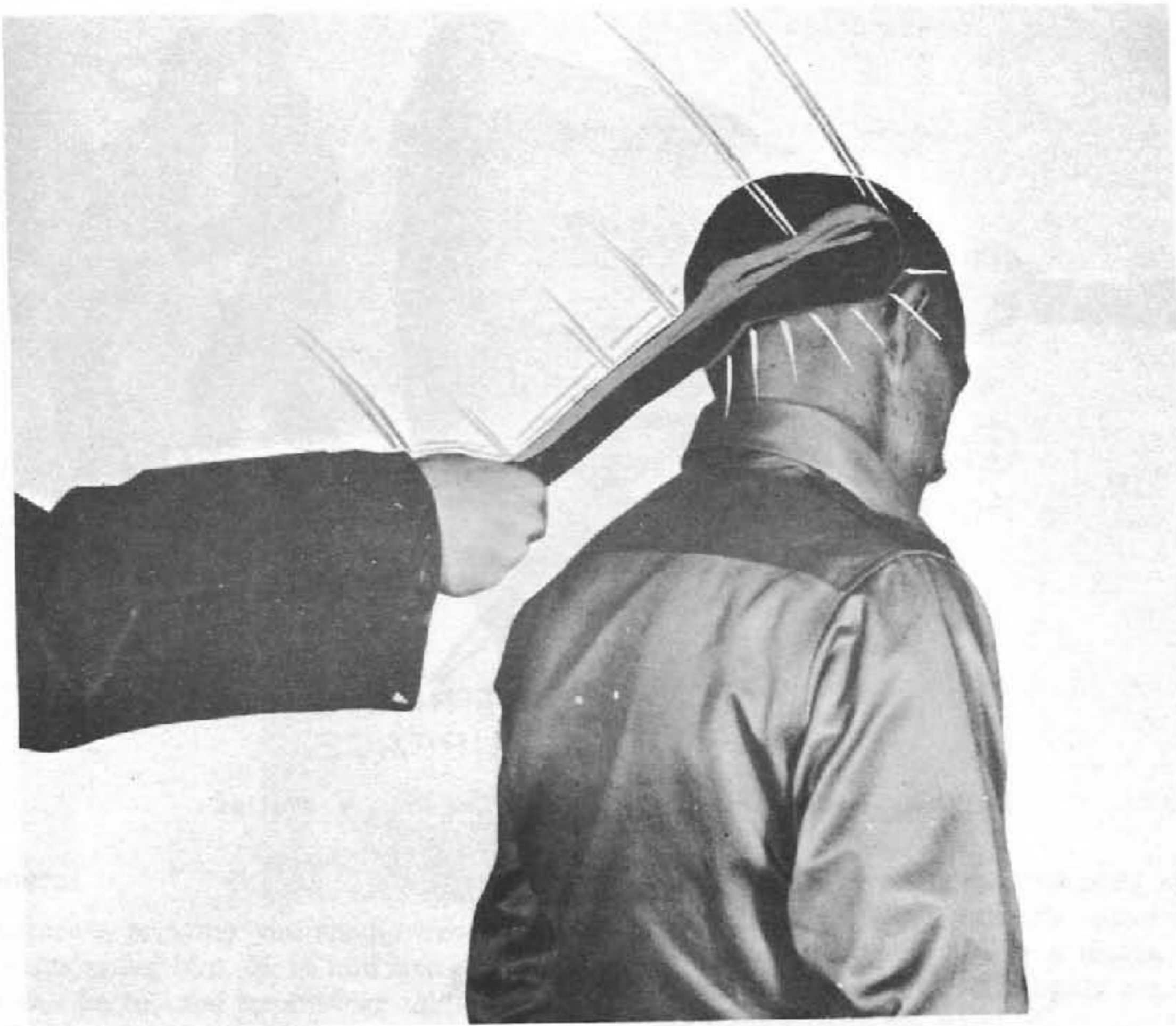

Figure 107. Homemade blackjack.

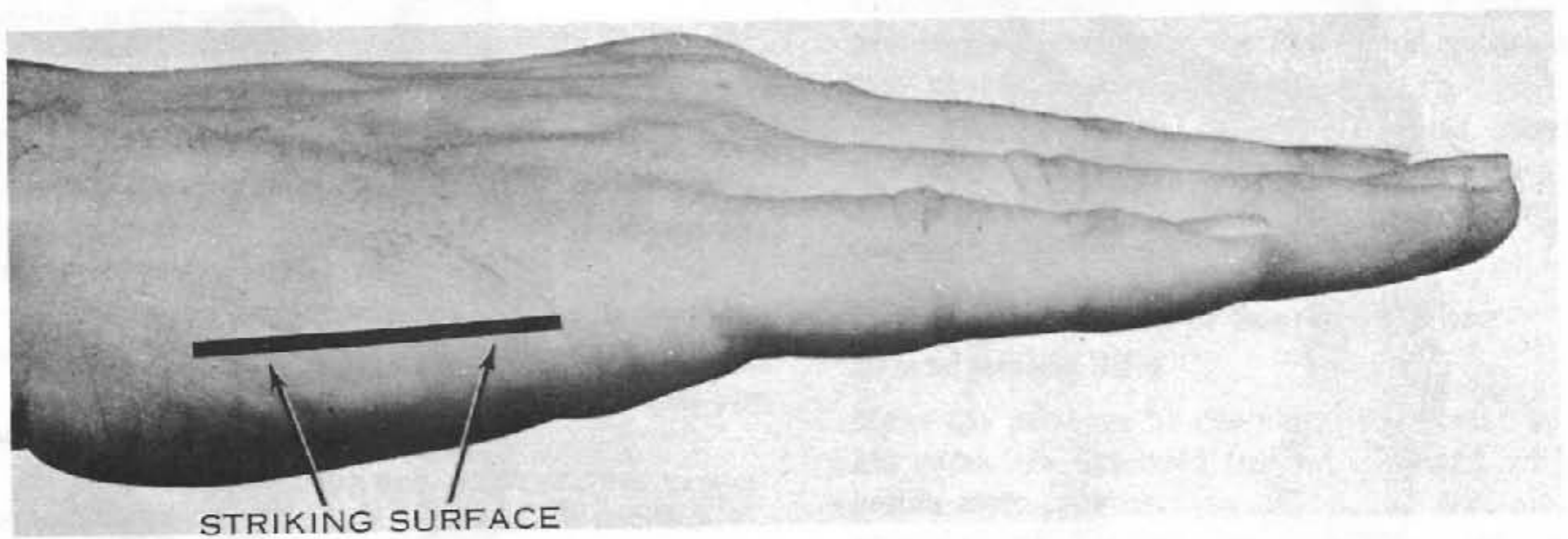

Figure 108. The hand—a weapon.
① Knife edge of hand



③ Padded fist
Figure 108—Continued.

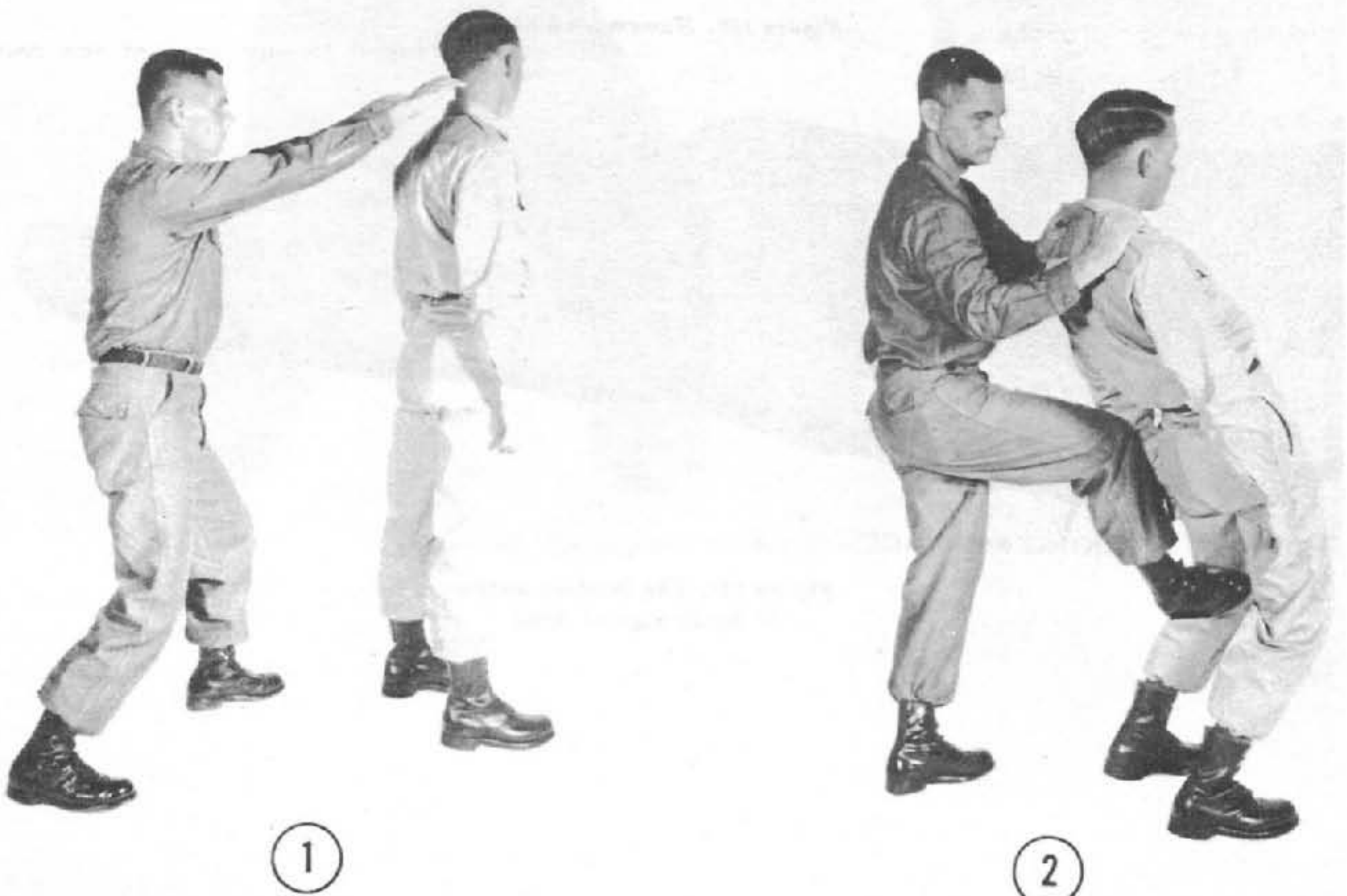

Figure 109. Rear takedown.



Figure 110. Rear strangle hold.

Section V. PRISONER SEARCHING AND SECURING

151. General

If you capture a prisoner you should have assistance while searching him. Move him to a rear area where he can be covered by another soldier while you search. In extreme circumstances, however, it may be necessary to make a thorough search unassisted. Methods for an unassisted search are presented in this section.

152. Rules for Searching

The rules you should follow when searching a prisoner are:

- a. Indicate by speech and actions that you are confident and will shoot if necessary.
- b. Do not let your prisoner talk, look back, move his arms, or otherwise distract you.
- c. Never attempt to search a prisoner until you have him in an off-balance position.
- d. Do not move within arm reach of your prisoner until you have him in an off-balance position.
- e. If armed with a pistol while searching a prisoner hold it at your hip in a ready position and keep it on the side away from him.
- f. When you have assistance, keep out of your partner's line of fire. One soldier conducts the search while the other remains far enough away to observe the prisoner at all times.
- g. Do not relax your guard after completing your search.

153. Techniques of Search

- a. The "pat" or "feel" method of searching a

prisoner will reveal most weapons and concealed objects. Search the prisoner's entire body, paying particular attention to his armpits, arms, back, groin area, and legs. Thoroughly search the clothing folds around his waist, chest, and the top of his boots. Knives can be concealed on a string around the neck or taped to any area of the body. Be extremely cautious when putting your hand in a prisoner's pocket or in the fold of his clothes or he may grasp your arm and throw you.

- b. After the initial search, a detailed search of the prisoner is made when he is moved to a rear area. Force him to take off his clothing and thoroughly examine his body.

154. Prone Method of Searching When Armed with a Rifle

Make the prisoner lie down on his stomach so that his arms are extended beyond his head with his hands close together (fig. 111). His legs also are extended with his feet close together. Place the rifle muzzle in the small of his back, and keep the rifle upright. Grasp the rifle around the small of the stock with your index finger on the trigger. After searching from the rear, order him to turn over and search him from the front. Place the rifle muzzle on his stomach. Twist the muzzle into the prisoner's clothing to prevent it from slipping. You can also use the prone search method when armed with a pistol, but keep the pistol at your hip while searching. You will have to use arm-and-hand signals for non-English-speaking prisoners.

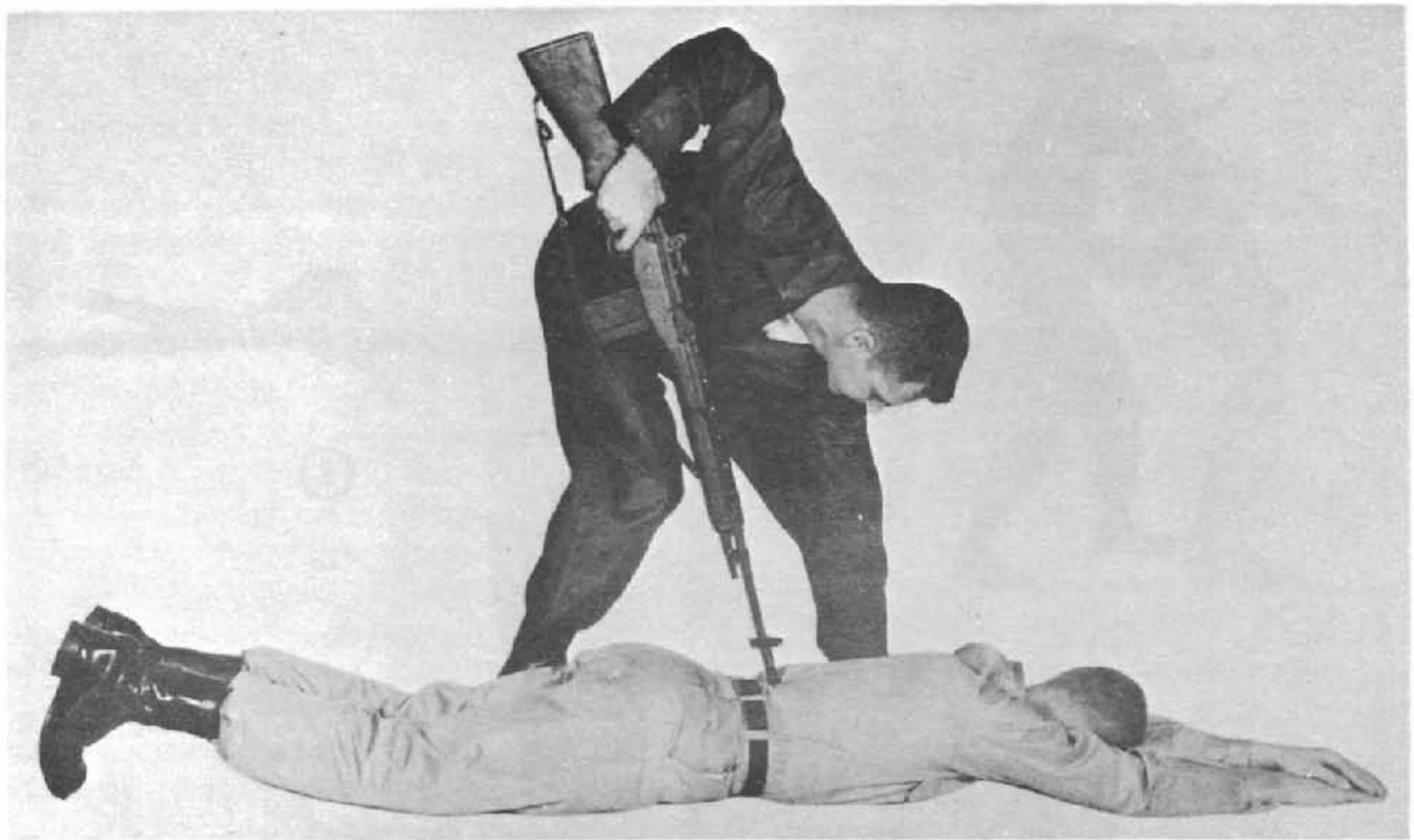

Figure 111. Prone method of search when armed with a rifle.

155. Kneeling Method of Searching When Armed with a Rifle

Force the prisoner to interlock his hands behind his head and kneel (fig. 112). He must bend forward until he just is able to maintain his balance. While searching his left side, hold the rifle in your right hand, muzzle jammed in the small of his back. Put your left leg between his legs and against his buttocks. In this position you can knock him quickly forward by thrusting with your left knee. When searching his right side, hold the rifle in your left hand and put your right leg between his legs with your knee against his buttocks. You also can use this method when armed with a pistol, but keep the pistol at your hip while searching.

156. Lean-To Method of Searching When Armed with a Pistol

Have the prisoner lean against a wall, tree, fence, truck or other upright object, one hand over the other, with his feet crossed and extended as far as possible to the rear. This puts him off balance. To search his left side, place your left foot in front of his feet and keep the pistol at your right hip (fig. 113). If the prisoner attempts to move, kick his feet out from under him. To search the prisoner's right side, switch the pistol to your left hand and place your right foot in front of his feet. For other lean-to methods of searching see FM 19-5.

157. Standing Method of Searching When Armed with a Pistol

a. Make the prisoner spread his legs far apart and place his hands on top of his head, fingers interlocked (①, fig. 114).

b. When you move close to search his front, place your foot against his heel and turn your body to the side to protect your groin (②, fig. 114). Search thoroughly and be alert.

158. Searching More Than One Prisoner

When armed with a pistol you can search more than one prisoner at a time by using any of the methods presented in this paragraph. Remember, however, to watch all of them and do not look away as you search for hidden weapons.

a. The Lean-To Method.

(1) When using this method keep the pistol in your right hand and search the left side of the first prisoner (①, fig. 115).

(2) Step back and have the first prisoner move to the far end of the line and have him resume the lean-to position. Search the left side of the remaining prisoners in the same manner (②, fig. 115).

(3) After all prisoners have been searched on the left side you move to the right side of the line. Hold the pistol in your left hand and search the right side of each prisoner. As you finish searching each prisoner have him move to the far



Figure 112. Kneeling method of searching when armed with a rifle.

end of the line and resume the lean-to position.

b. The Kneeling Method.

(1) To search more than one prisoner using the kneeling method you make them all assume the same position in column about 4 or 5 feet apart (①, fig. 116).

(2) First you search the prisoner at the rear of the column and have him move to the front where he resumes the kneeling position (②, fig. 116). Search the remaining prisoners from the rear and move each forward to the front as you finish with him. When you are alone and armed with a rifle, the kneeling search is the best method to use.

159. Securing and Gagging of Prisoners

The most effective way to control a prisoner is to

tie him. You can tie a prisoner securely with pieces of clothing or equipment such as shoelaces, leather or web belts, neckties, handkerchiefs, or twisted strips of cloth. If a patrol has the mission of capturing prisoners, it always should carry pieces of rope or flexible wire.

160. Belt Tie

a. Take the prisoner's belt and order him to lie on his stomach. Cross his arms behind his back and place the running end of the belt toward his back and the buckle toward his feet. Hold the buckle on the wrist of his bottom arm and tightly wrap the running end of the belt around his wrist several times. Place the running end parallel with his spine and inside the wrist of his upper arm (①, fig. 117).

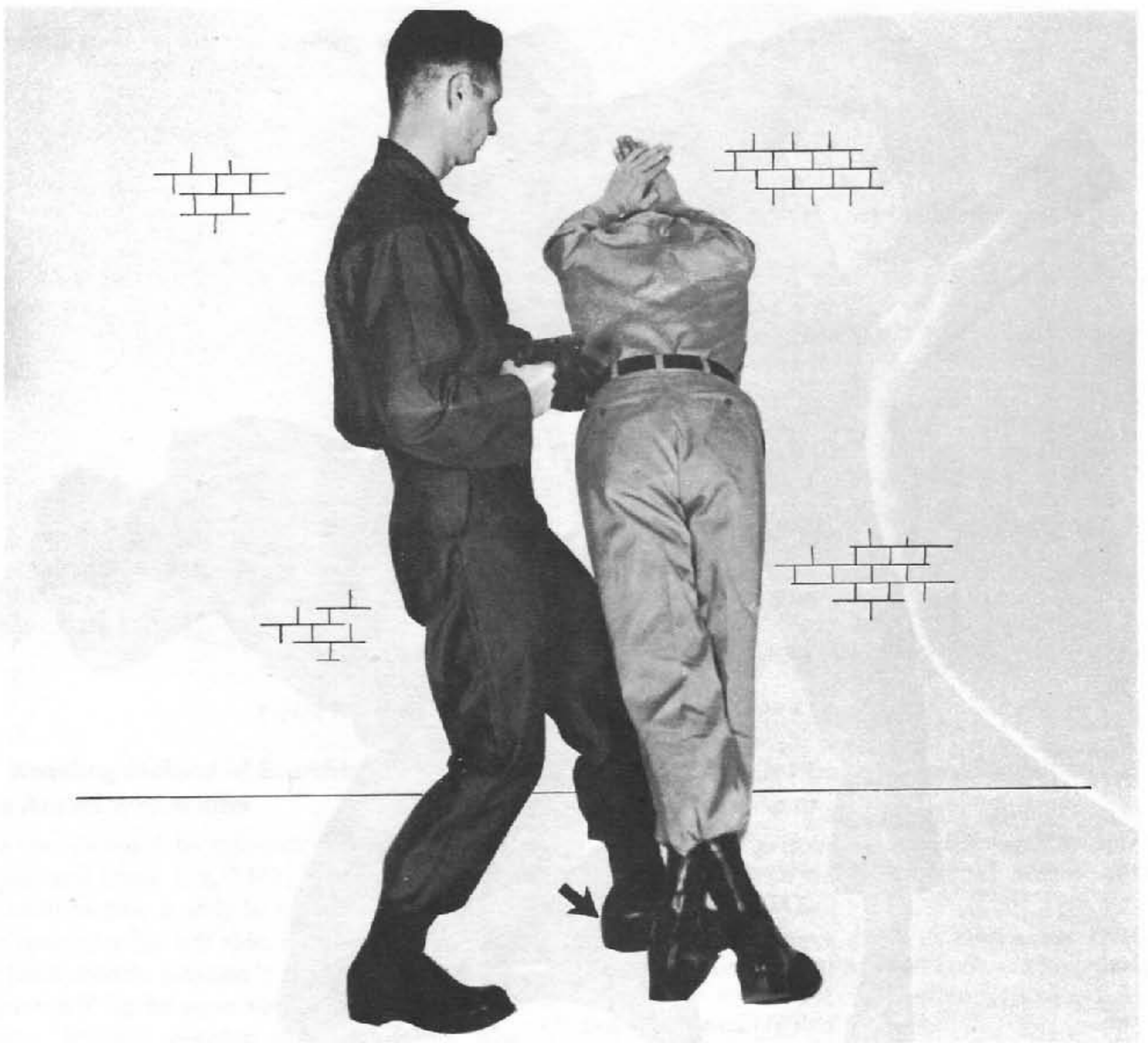

Figure 113. Lean-to method of search when armed with a pistol.

b. Now wrap the running end around the wrist of his upper arm several times. Be sure to keep the prisoner's arms as close together as possible and to wrap the belt as tight as possible (②, fig. 117).

c. Fasten the belt end in the buckle (③, fig. 117). Although this is an effective means of tying, you should use it only when the prisoner is under close surveillance.

161. Shoelace Tie

a. Two 27-inch shoelaces or one 72-inch bootlace is needed for this tie. Have the prisoner remove his shoelaces or bootlaces. You can make this tie with the prisoner's hands either in front of his body or behind his back, the latter being more effective. Place his hands back to back, wrists touching each other. Take one lace and tightly wrap it several times around both his wrists. Now, wrap the lace end around the lace between the insides of his

wrists. This will further tighten the outside loops. Tie the ends of the lace together with any conventional knot (①, fig. 118).

b. Next, tie his two little fingers together using one end of the second lace. Pass the remainder of the lace over the loop around the wrists and tie his thumbs together. When you pass the second lace around his wrists be sure to pull it tight and keep it tight when tying his thumbs (② and ③, fig. 118).

162. The Lead Tie

A piece of rope or two long bootlaces are needed for this tie. Make the prisoner lie face down. Tie his hands behind his back using any conventional knot. Force his arms behind his back in a strained, up position. Pass the rope or lace around his neck and tie it around his wrists. The length of the loop around his neck should be short enough to force him to keep his arms in a strained position to re-

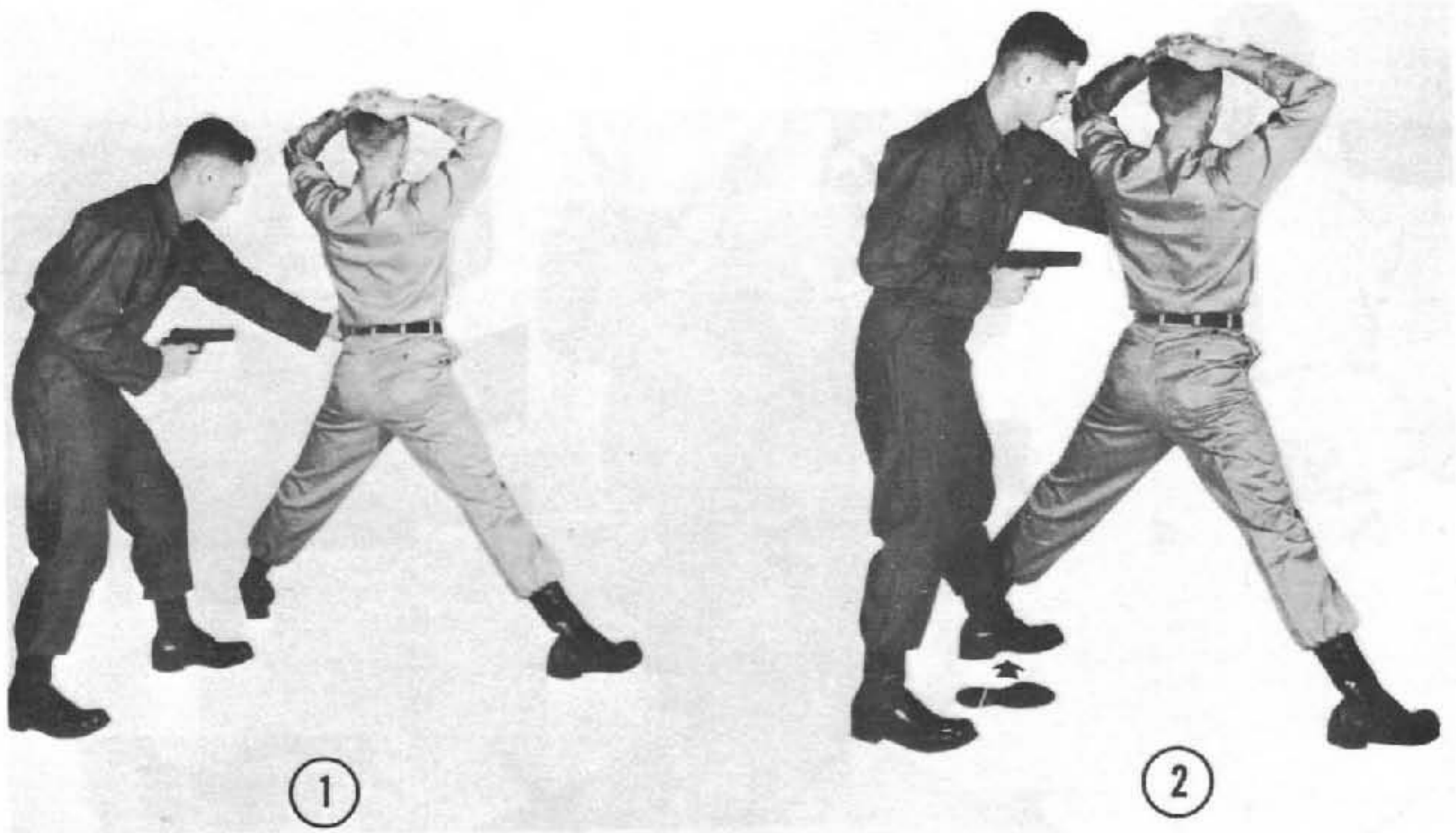

Figure 114. Standing method of search when armed with a pistol.



Figure 115. Lean-to method.



Figure 116. Kneeling method.

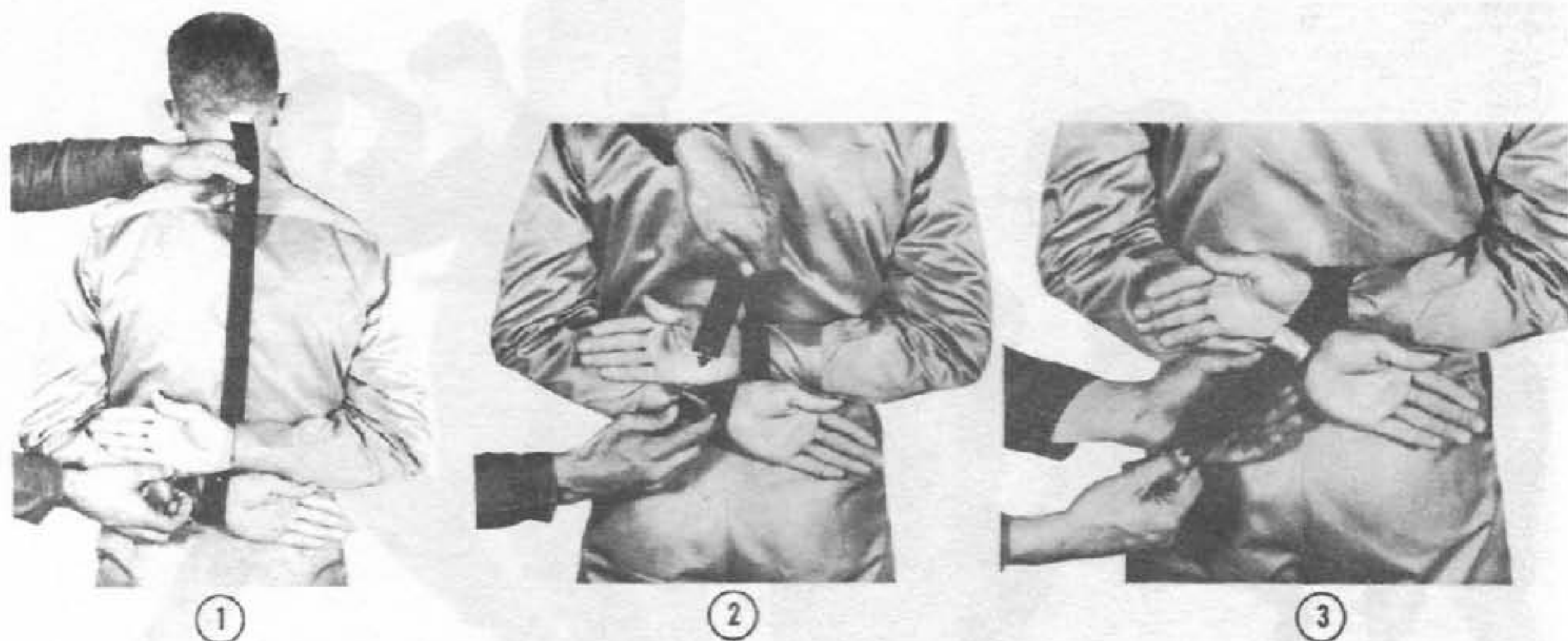

Figure 117. Belt tie.

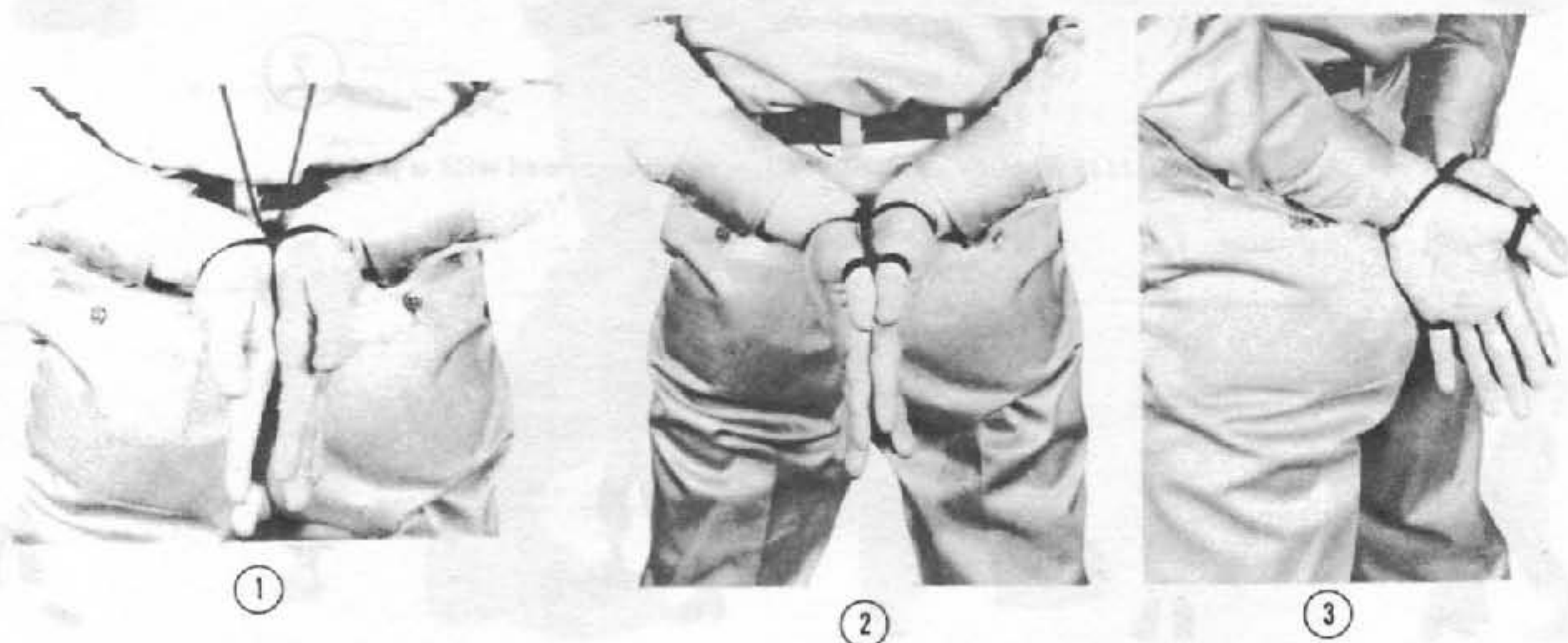

Figure 118. Shoelace tie.

lieve pressure on his throat (fig. 119). The prisoner can be subdued easily by jerking the rope as you walk behind him.

163. The Hog Tie

Tie the prisoner in the lead tie as shown in figure 119. Double his legs up behind him and tie his ankles with the rope so that they remain in position. Any struggle to free himself will result in strangulation. When correctly applied, there is no escape from this tie (fig. 120).

164. Handkerchief Gag

A gag prevents a prisoner from crying out. Force a handkerchief or a strip of cloth into the prisoner's mouth. A handful of turf will do if nothing

else is available. Then tie a handkerchief around the prisoner's mouth (fig. 121).

165. Stick Gag

IF A STRIP OF CLOTH IS NOT AVAILABLE, A STICK CAN BE USED. Stuff the prisoner's mouth with a piece of turf. Force the stick between his teeth like a bit in a horse's mouth. Tie the stick with a shoelace around the back of his neck (fig. 122).

166. Adhesive Tape Gag

Place several strips of tape across the prisoner's mouth (fig. 123). The tape should be at least 1-inch wide and 5 inches long. Stuffing a handkerchief, a piece of turf, or a strip of cloth into his mouth first will make the gag more effective.

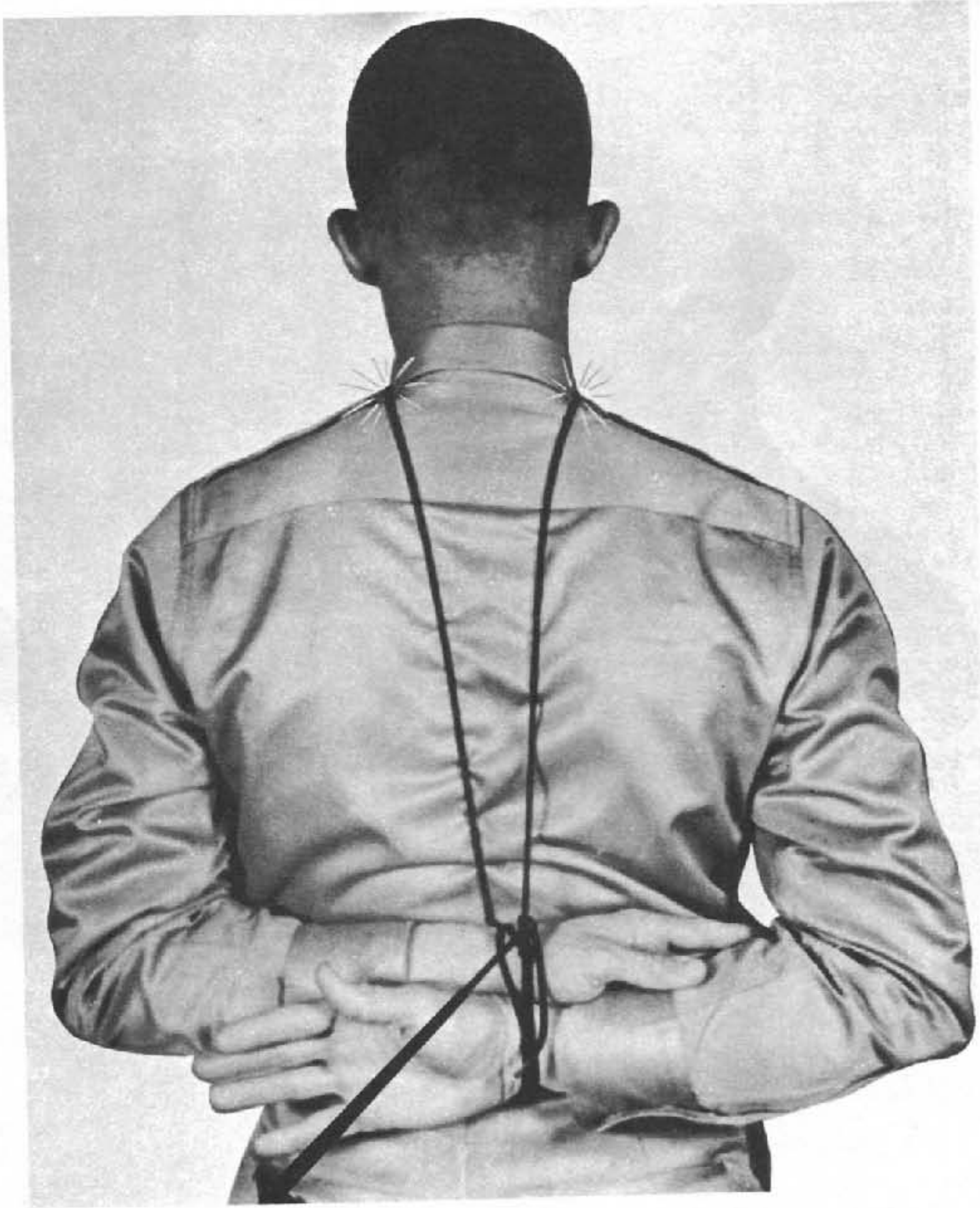

Figure 119. Lead tie.

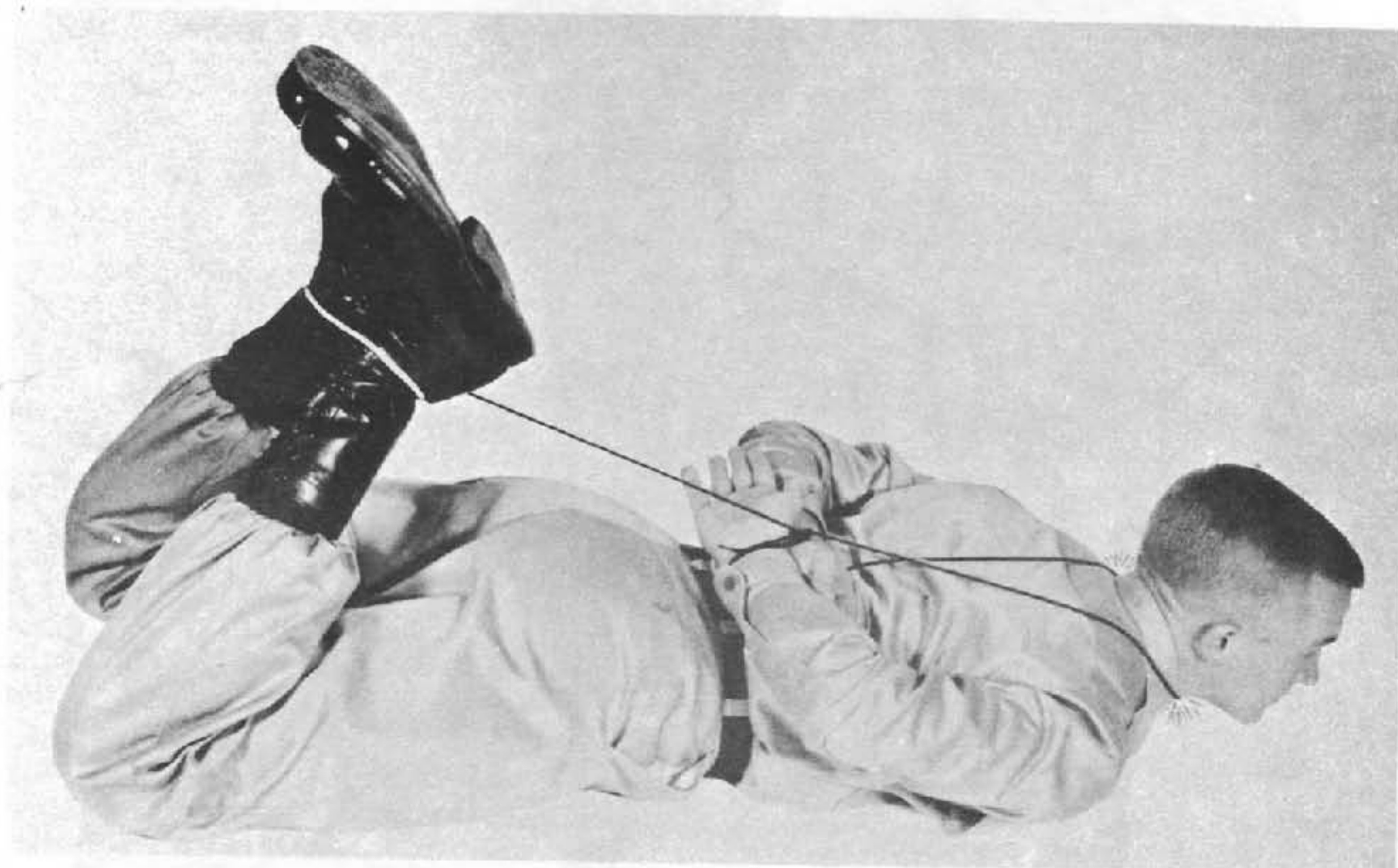

Figure 120. Hog tie.

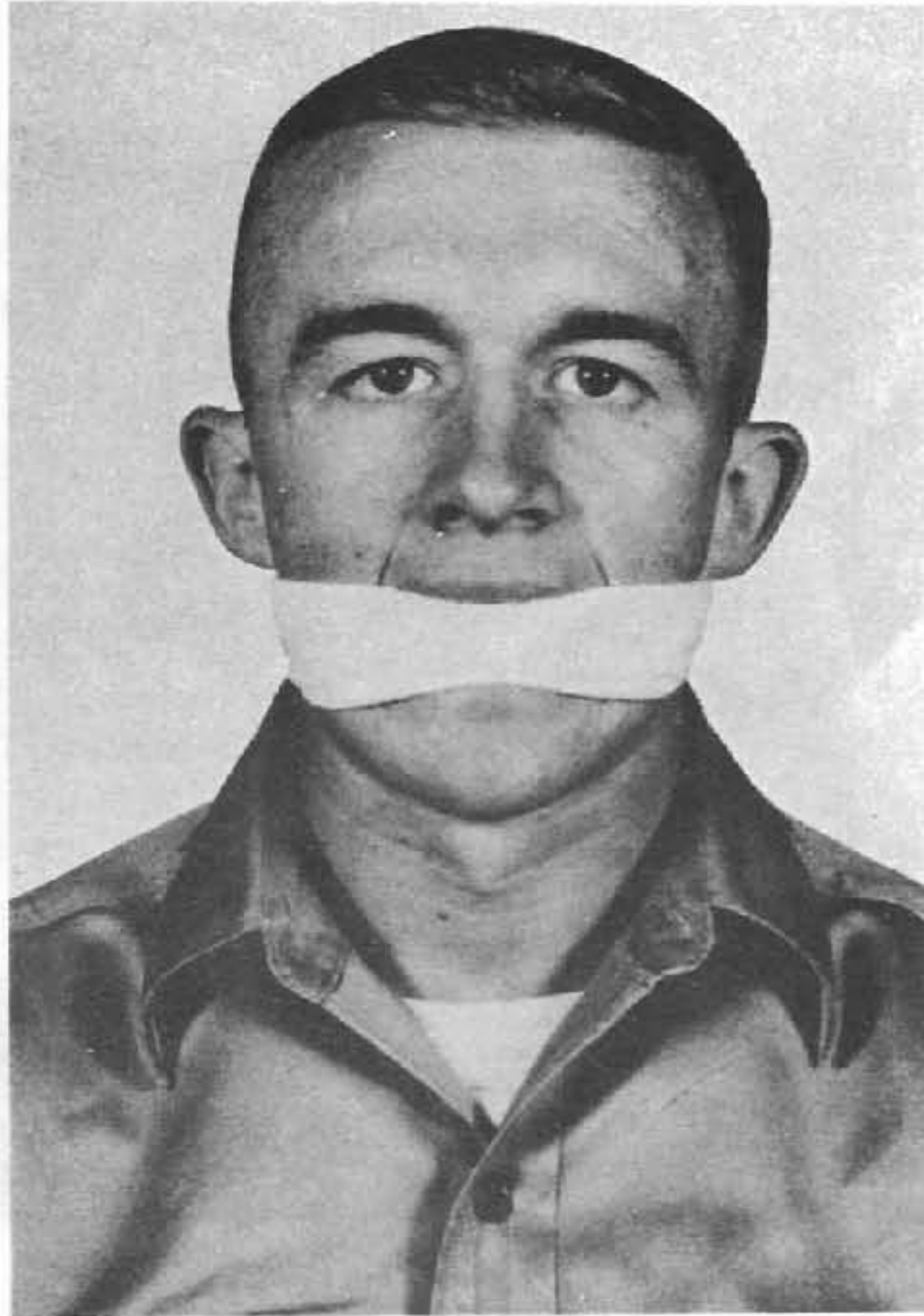

Figure 121. Handkerchief gag.

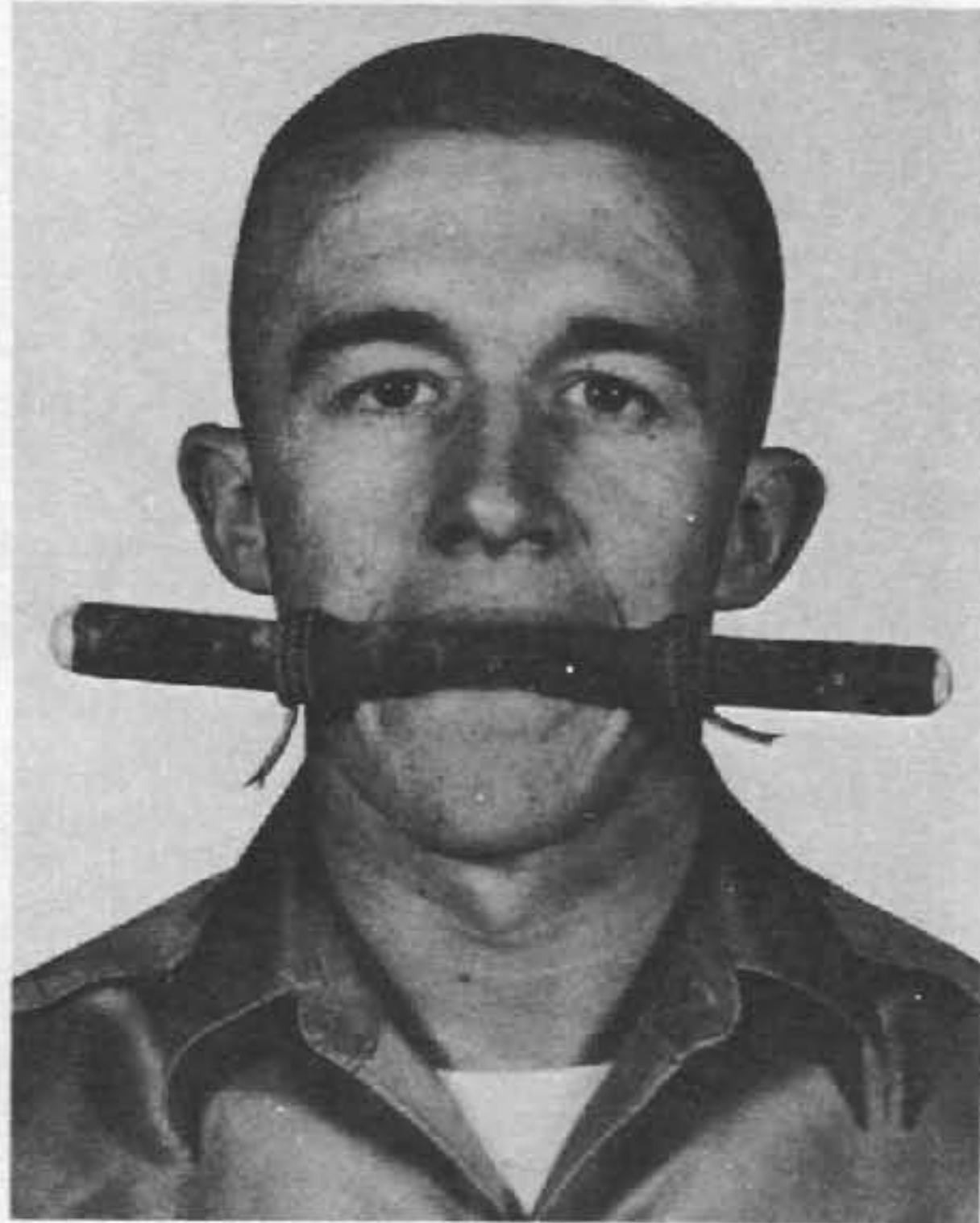

Figure 122. Stick gag.

APPENDIX

The Army Physical Fitness Test

APPENDIX

100

APPENDIX

The Military Training

APPENDIX

and Academic Training

APPENDIX

APPENDIX



Figure 123. Adhesive tape gag.

This Page Intentionally Left Blank

APPENDIX A

REFERENCES

AR 600-9

The Army Physical Fitness Program.

AR 672-5-1

Awards.

FM 19-5

The Military Policeman.

FM 21-20

Physical Readiness Training.

FM 22-5

Drill and Ceremonies.

ASubjSecd 21-150

Physical Contact—Confidence Training.

This Page Intentionally Left Blank

APPENDIX B

BAYONET ASSAULT COURSE

Section I. INTRODUCTION

1. Description

A bayonet assault course may be used, if available, to improve the proficiency of the rifle-bayonet fighter as well as improve physical fitness. It is a series of lanes to accommodate several men negotiating the course at the same time. The course consists of targets to attack and obstacles to overcome during progress through the course (fig. 124). Assault courses should be laid out on rough, preferably wooded terrain. The length of the course should be 300 meters. Less space is acceptable if terrain dictates. Natural obstacles such as streams, ravines, ridges, and thick woods should be included; and artificial obstacles such as dirt mounds, craters, wire entanglements, fences, log wall, hurdles, and horizontal ladders, should also be a part of the course.

2. Objective

The bayonet assault course may also be used as a qualification course to test the degree of proficiency of a rifle-bayonet fighter. When used as a part of rifle-bayonet training the course accomplishes the following:

- a. Aids in developing speed, strength, endurance, coordination, and accuracy.
- b. Provides rifle-bayonet fighting under conditions approximating combat.
- c. Offers a challenge to the soldier's determination and will-power which are so essential in combat.
- d. Provides a means for establishing good habits in group action and teamwork.
- e. Measures skill in rifle-bayonet fighting.
- f. Provides a means for maintaining skill by continued training and practice.

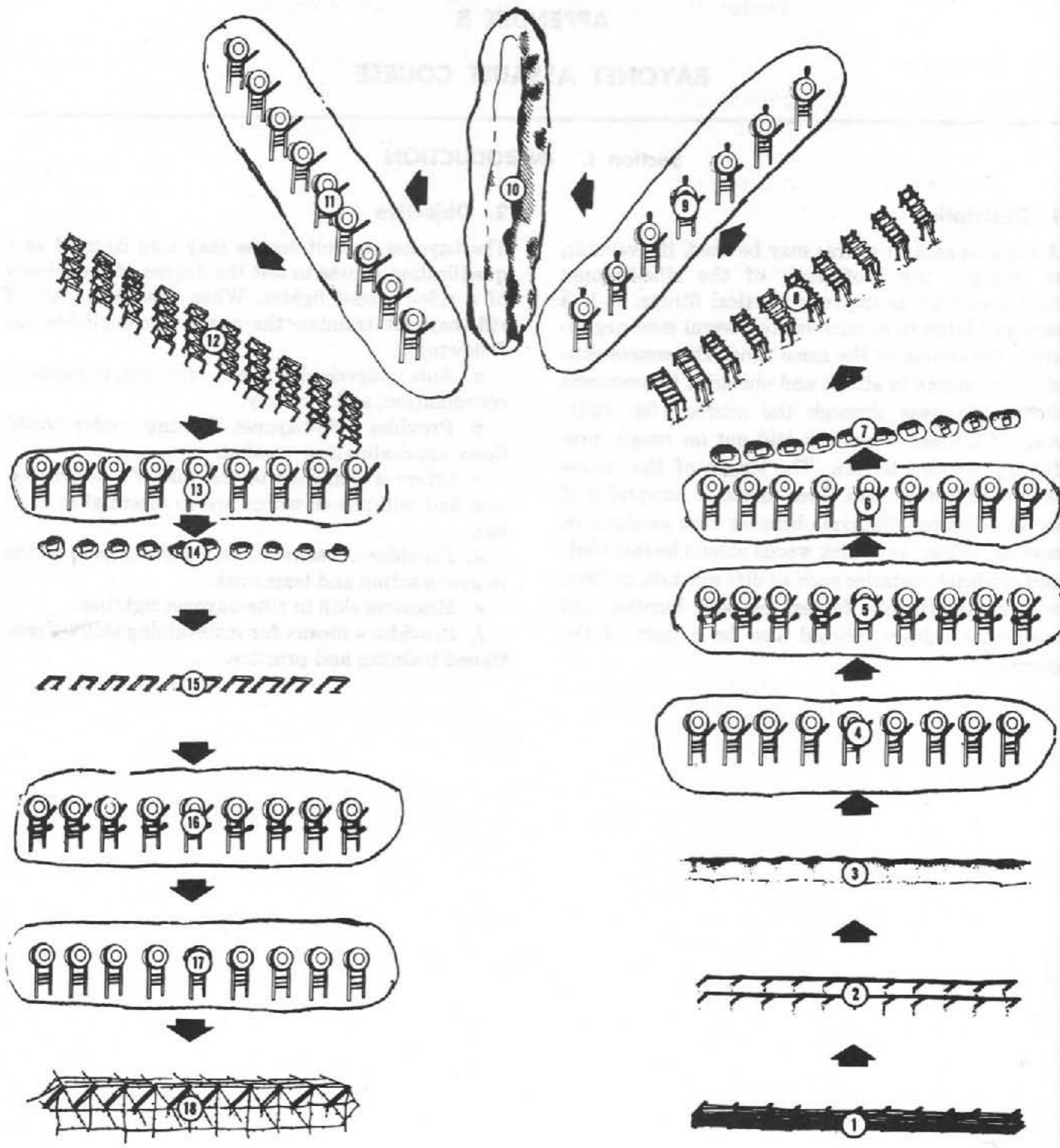

FINISHING POINT

STARTING POINT

- | | |
|--------------------------------------|-------------------------------------|
| 1. LOG WALL | 10. DIRT MOUND |
| 2. HURDLES | 11. PARRY THRUST |
| 3. DITCH JUMP | 12. TUNNEL CRAWL |
| 4. PARRY LEFT THRUST | 13. PARRY RIGHT THRUST |
| 5. PARRY RIGHT BUTT STROKE TO GROIN | 14. PRONE TARGETS IN CRATERS |
| 6. PARRY THRUST | 15. FENCE VAULT |
| 7. PRONE TARGETS IN CRATERS | 16. PARRY LEFT BUTT STROKE TO GROIN |
| 8. LOG BALANCE AND HORIZONTAL LADDER | 17. THRUST |
| 9. PARRY LEFT BUTT STROKE TO HEAD | 18. DOUBLE APRON BARB WIRE FENCE |

Figure 124. Example of 10-lane, 300-meter bayonet assault course.

Section II. TRAINING ON THE ASSAULT COURSE

3. General

The method of negotiating the assault course should be explained and demonstrated before the men are required to run the course. The attack is made without hesitation and the importance of swift and continuous bayonet attack should be emphasized. The men are required to run the course with their rifles held in the attack position.

4. Preliminary Training on Bayonet Court

Prior to training on the assault course the bayonet training court (fig. 17) may be used as an assault course in order to teach the men how to attack while moving rapidly toward an enemy. To use the court in this manner, students are lined up behind each of 10 files of targets (two files are blocked by the instructor's platform) (fig. 17). The movement to be executed against each target must be designated by the instructor or by the use of a sign in front of each target. On command, the men negotiate the course in waves of 10 students abreast. As the students complete the course, they should clear the last target and again line up in their respective files at that end of the course. After

all men have completed the course, the course may be run again in the opposite direction.

5. Practice Running of the Assault Course.

During the training program, the men should first negotiate the course at a moderate pace and increase their speed as technique and physical condition improve. The instructor insures that discipline and organized control are maintained. The instructor and his assistants will be stationed along the course to observe the methods of attack and to make corrections when necessary.

6. Targets

Different types of targets should be constructed as an aid to training. Experience should be gained on four basic targets prior to running the qualification course. These are the thrust, the parry-thrust, the parry-butt stroke to the groin, and the parry-butt stroke to the head targets (fig. 125). The four basic targets are variations of the multipurpose bayonet target as described in paragraph 15. These targets are durable and if used properly will not damage rifles. If substitution must be made, hard objects or materials should not be used for butt stroke heads or target faces so as to minimize rifle damage.

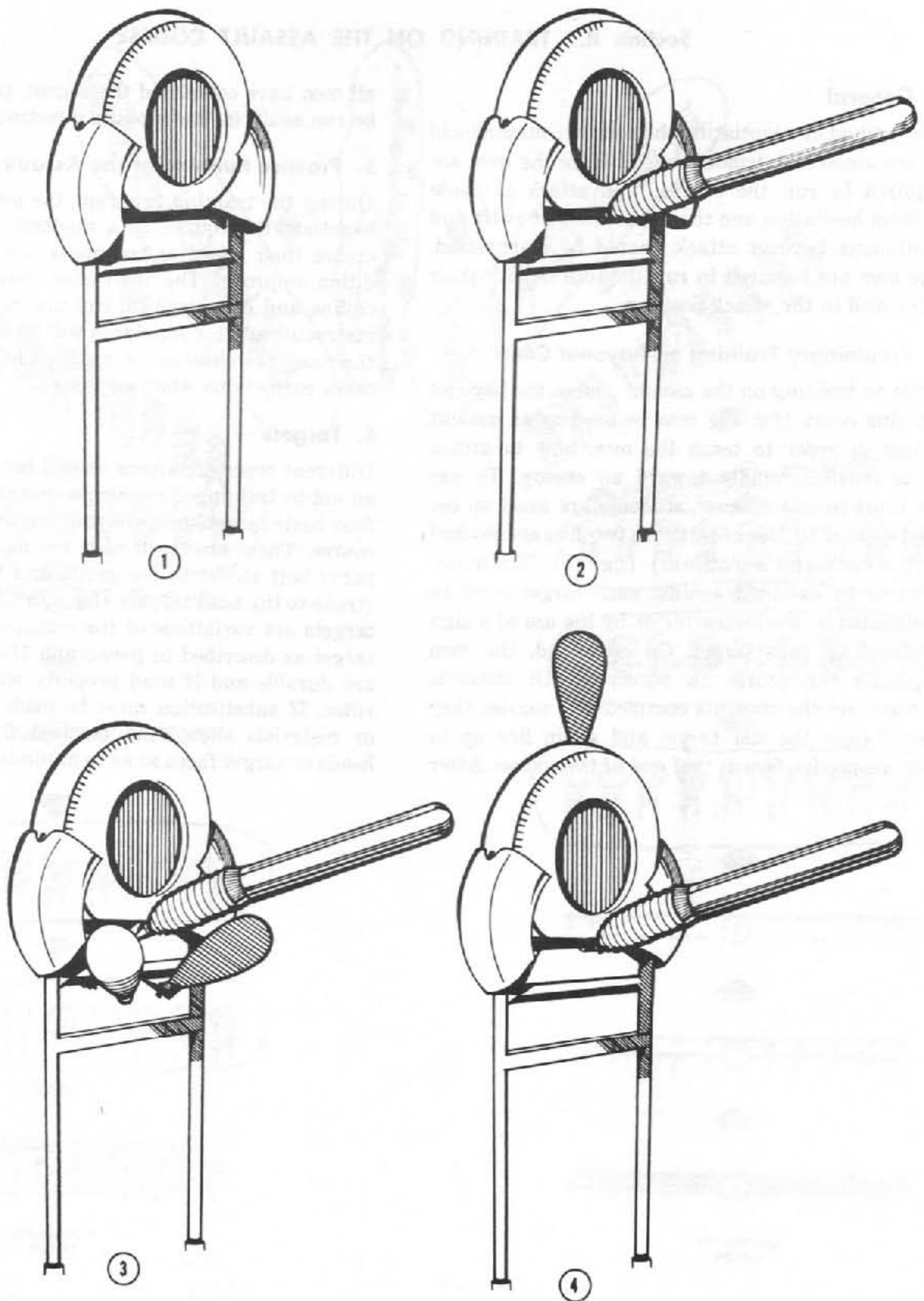

1. THRUST
2. PARRY THRUST TARGET

3. PARRY-BUTT STROKE TO THE GROIN TARGET
4. PARRY-BUTT STROKE TO THE HEAD TARGET

Figure 125. Types of targets (schematics).

Section III. THE QUALIFICATION COURSE

7. Purpose

The qualification course gives the unit commander a means to measure the proficiency of his men in the technique of rifle-bayonet fighting, and it increases esprit de corps within a unit by creating a competitive attitude and by offering special recognition to the men who qualify. It also makes demands on the soldier's speed, accuracy, strength, and endurance that approach the demands made on him in actual combat.

8. The Course

A bayonet assault course is 300-meters in length employing targets, obstacles, and natural terrain features as described in paragraph 1, and as illustrated in figure 124. The same course can be used for both practice and qualification. Qualification can be determined on any assault course as follows:

a. The course will contain a minimum of—

(1) Four types of targets to include thrust targets (①, fig. 125), parry thrust (②, fig. 125), parry butt stroke to the groin (③, fig. 125), parry

butt stroke to the head (④, fig. 125), or prone target in crater (fig. 126).

(2) Seven types of obstacles as depicted in figures 127 through 133.

b. The course will contain a minimum number of lanes to permit one-half of a squad to run at the same time under the squad leader, assistant squad leader, or other designated leader.

9. Running the Course for Qualification

For qualification the soldier assumes the prone

position in rear of the starting line. At the command UP, he springs to his feet with his weapon at the attack position and runs toward the first target. He negotiates each obstacle and attacks each target in turn, running the course in the shortest possible time. Each man is scored individually (para 10b).

10. Support Requirements

To conduct qualification runs of the assault course the following must be provided:

a. *Supervisory Personnel.* To insure impartial scoring and to maintain high standards for qualification, men who are not members of the company running the course are detailed to act as scorers. The scorers should be selected well in advance so that the officer in charge can refresh himself on the subject and, if necessary, train the scorers. The officer detailed to administer the course should be experienced in rifle-bayonet training. His primary duty is to assign a scorer to each target and to insure that the scorer is qualified to grade the men



Figure 126. Prone target in crater.

on the execution of the movements for that target. The officer in charge has overall supervisory responsibility for the scoring. He provides each scorer with scoresheets and totals each man's score for the entire course.

b. *Scoring Standards.* Since assault courses at different installations may vary as to length and number of targets, it is not practical to prescribe a standard time limit or an invariable number of points for qualification. As a guide, 30 seconds for each 50 meters of a course can be used to establish

a time limit. However, the total distance covered should be 300 meters, and on short courses it will be necessary to re-run portions of the course to cover the required distance and attack eight targets as recommended. To qualify, the soldier must score at least 75 percent of the total possible points and must negotiate the course within the specified time limit. The officer in charge should orient each man

thoroughly on all requirements for the qualification course, including the maximum time allowed and the minimum number of points needed to qualify.

c. *Award.* A basic qualification badge as specified in AR 672-5-1, with the bayonet bar to indicate expert qualification, is awarded to participants who attain the qualifying score of 75 percent.

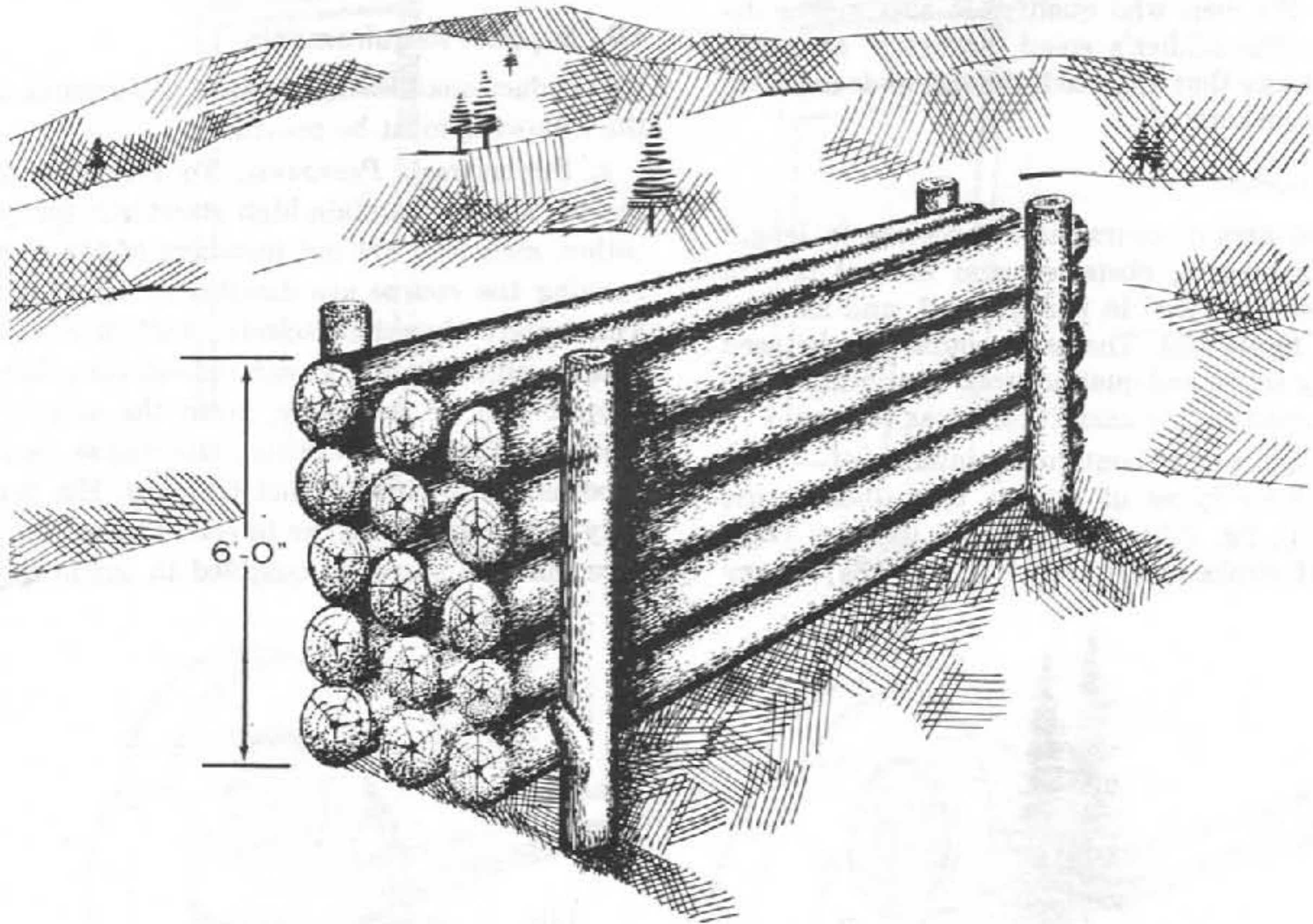

Figure 127. Log wall.



Figure 128. Hurdles.

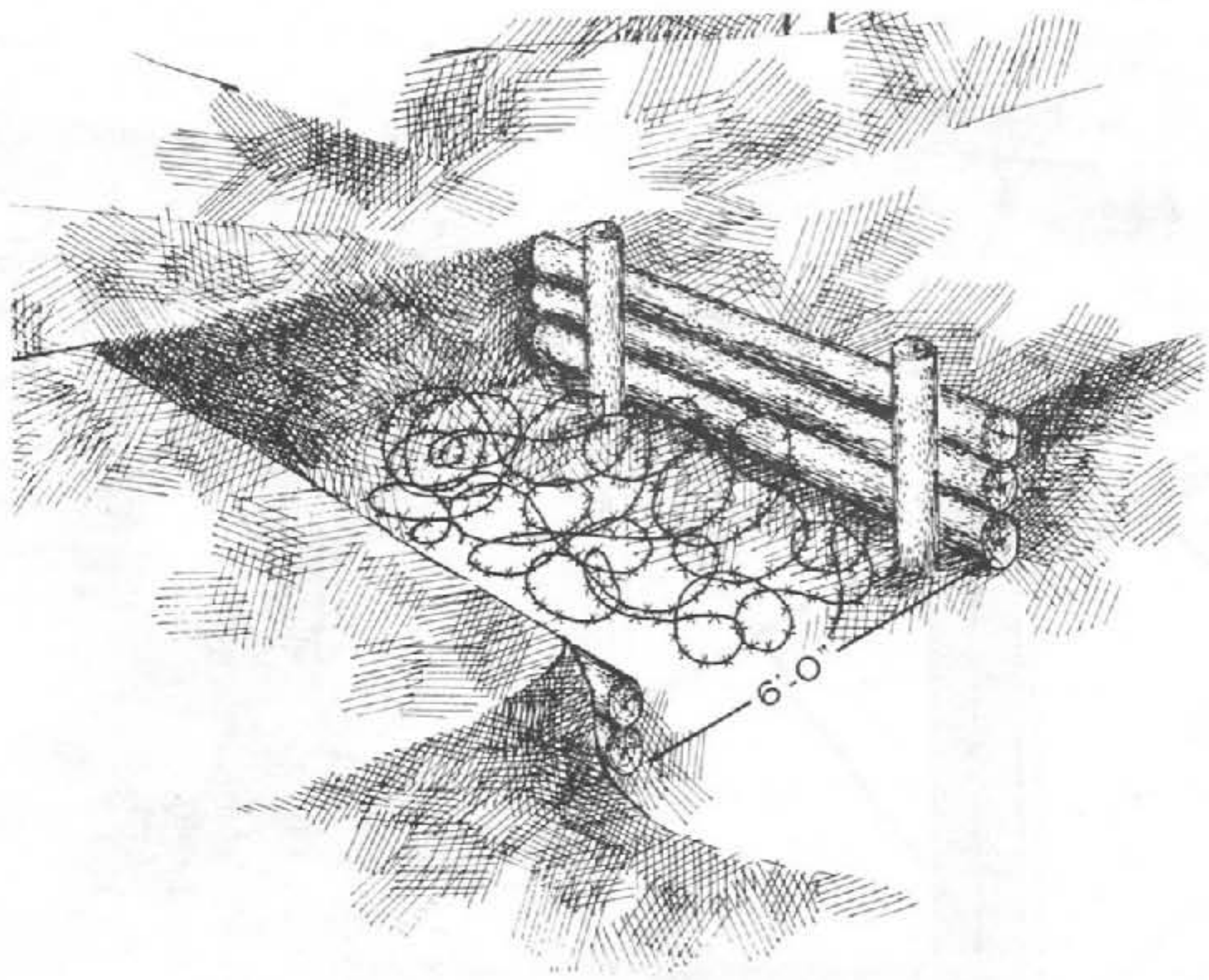

Figure 129. Ditch jump.

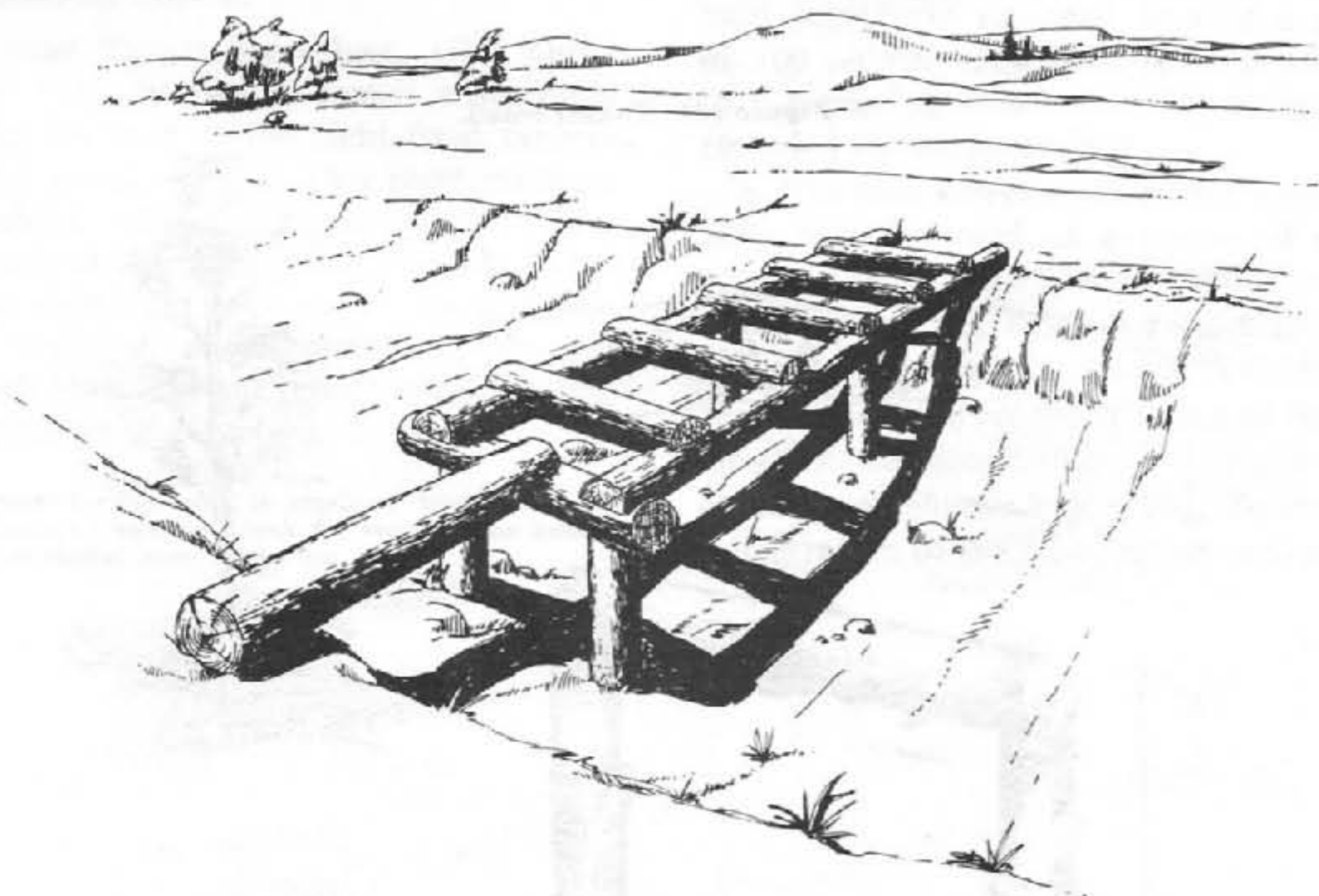

Figure 130. Log balance and horizontal ladder.

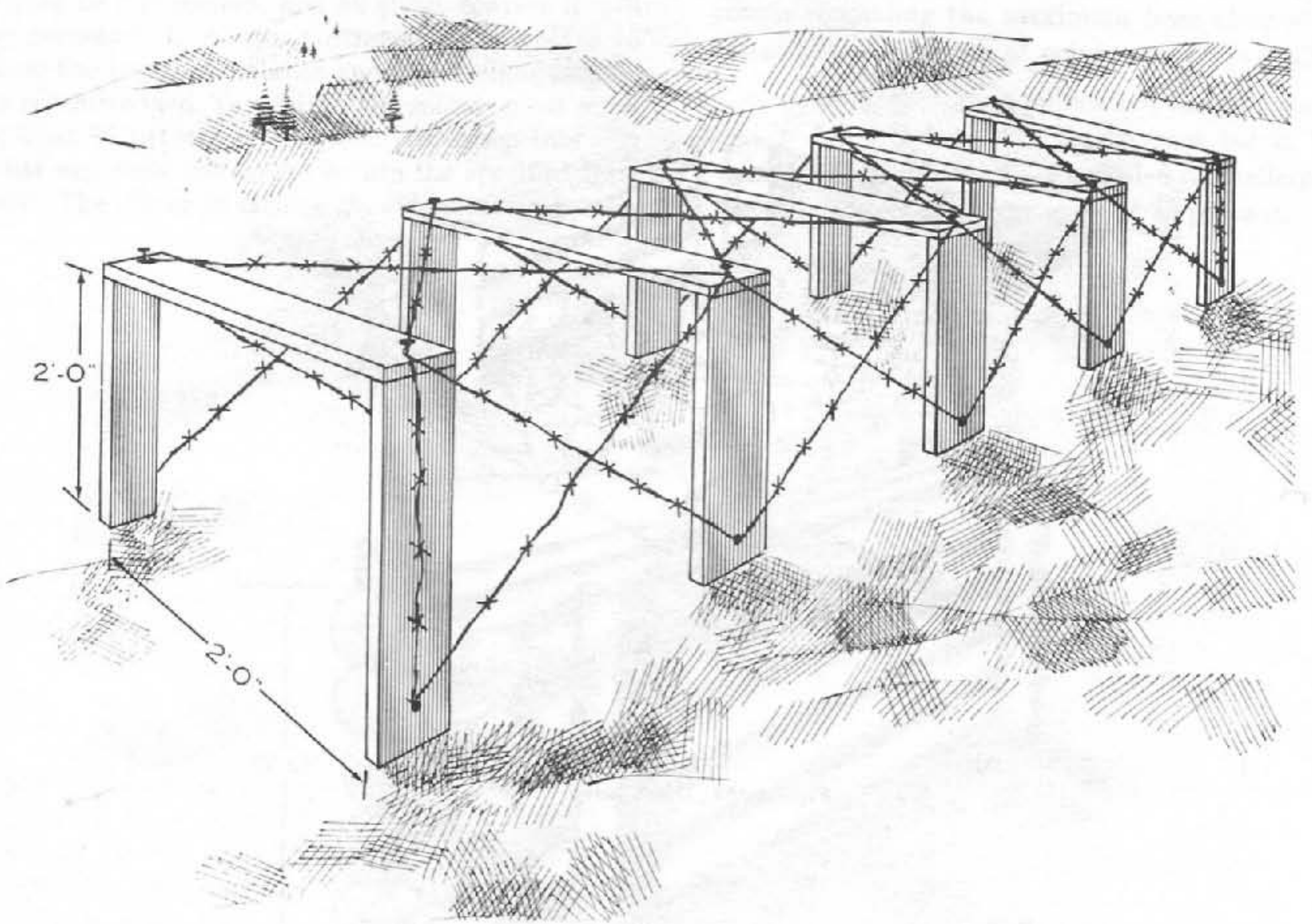

Figure 131. Tunnel crawl.

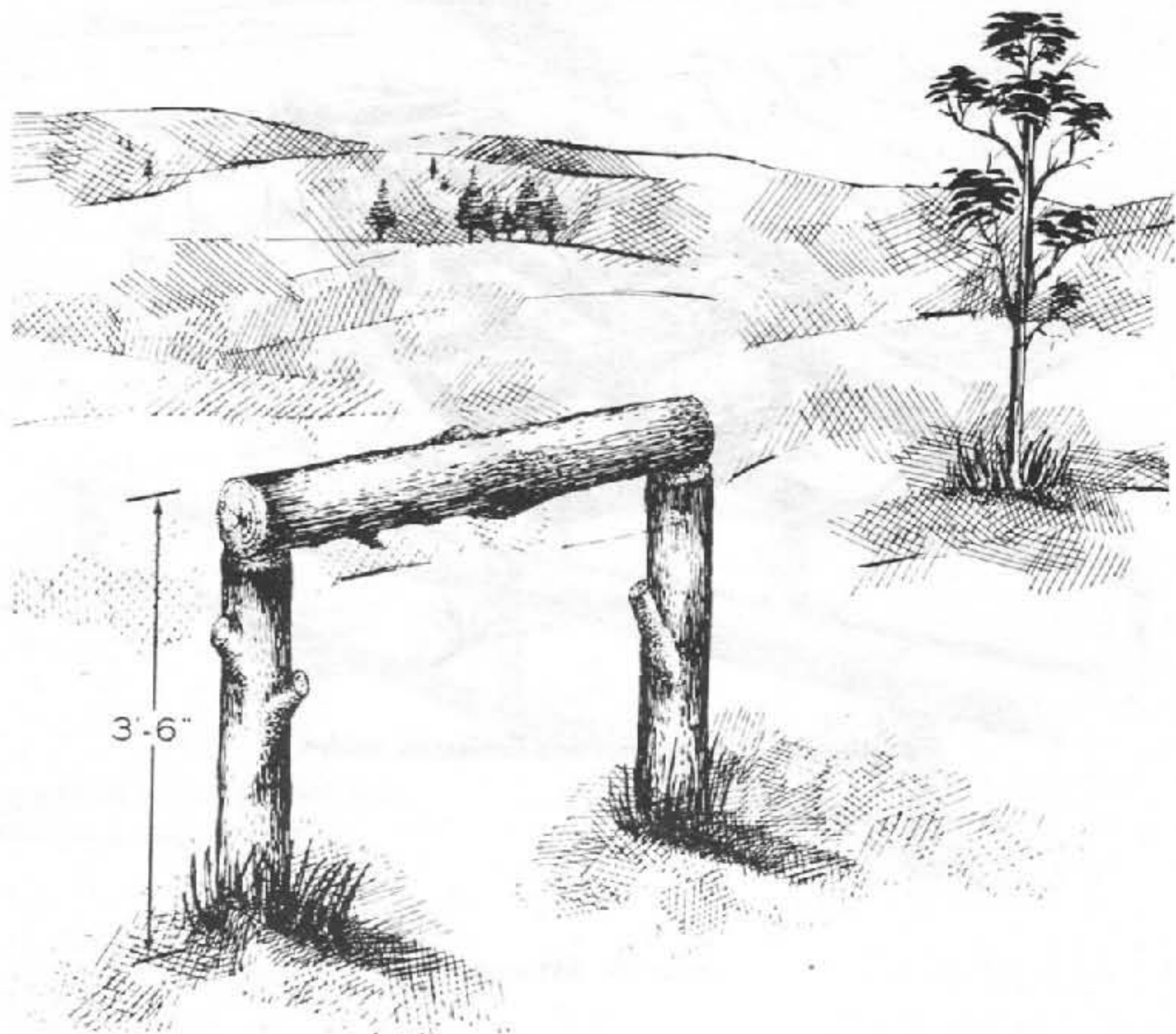

Figure 132. Fence vault.

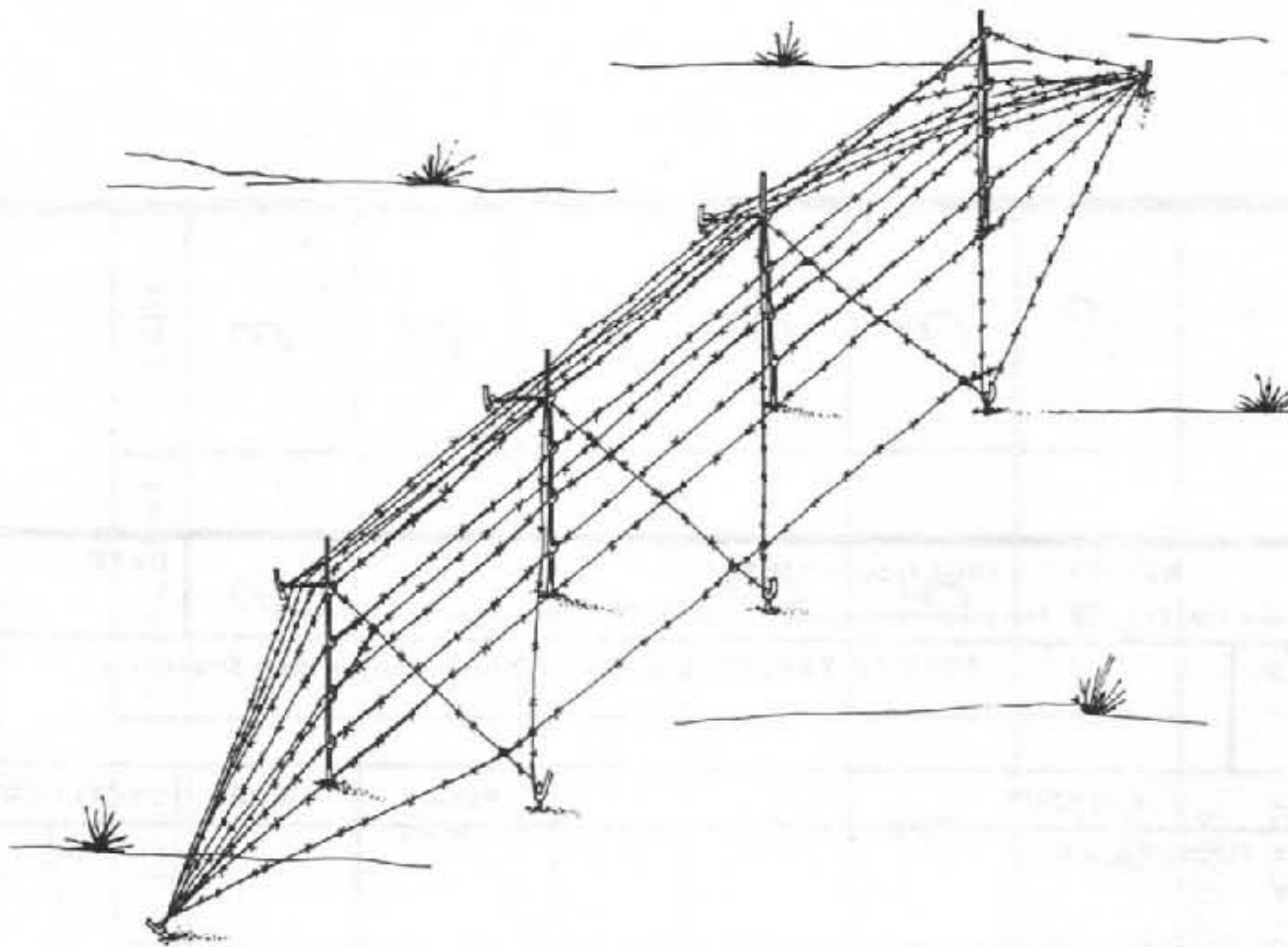

Figure 133. Double apron barbwire fence.

11. Scoresheets*

Three scoresheets are outlined below which are used to record performance of men who complete the Bayonet Assault Course.

a. The Bayonet Target Scoresheet, (DA Form 1770-R) (fig. 134), is used to insure a standard scoring system for each of the eight fixed targets on any bayonet assault course. This form contains the five standard criteria for scoring individual personnel on any of the targets. One of these scorecards must be scored for each man at each different target; therefore, eight scoresheets are required for each man. The maximum score possible on each fixed target is 25 points.

* These scoresheets are presented in duplicate, one filled in as an example for the user, and one blank for reproduction locally by means of a mechanical copying device.

b. The bayonet course qualification score sheet (fig. 135) is used to consolidate the eight separate scores awarded on the course. The scores of the individual are totaled on this scoresheet, and the total points are recorded (out of a possible total of 200 points). His total score is then converted to a percentage score and this percentage is also recorded on this scoresheet.

c. The lane scorer's record for bayonet test (fig. 136) may be used as a means of consolidating scores. The scorer at each target scores individual personnel on the bayonet target scoresheet (fig. 134) and then transfers each individual's score to the lane scorer's record. The use of this record will simplify the completion of bayonet qualification course scoresheets (fig. 135), following the administration of the qualification course.

BAYONET TARGET SCORESHEET			DATE	
For use of this form, see FM 21 - 150; the proponent agency is U, S, Continental Army Command.				
TARGET POST NUMBER	TYPE OF TARGET (i. e., Parry Thrust, Vertical Butt Stroke, etc.)			
ELEMENT	POOR	GOOD	EXCELLENT	GRADE
1. DID MAN ATTACK A VULNERABLE PART OF TARGET? (TOTAL POSSIBLE POINTS-3)				
2. DID HE SELECT PROPER MOVEMENT TO ATTACK TARGET AT THIS POST? (TOTAL POSSIBLE POINTS - 5)				
3. DID HE EXECUTE MOVEMENT PROPERLY (MAINTAINING HIS BALANCE AND SPEED)? (TOTAL POSSIBLE POINTS-7)				
4. DID HE DISABLE HIS OPPONENT? (TOTAL POSSIBLE POINTS-5)				
5. DID HE AGGRESSIVELY CONTINUE HIS ASSAULT TO NEXT POST? (TOTAL POSSIBLE POINTS - 5)				
TOTAL (MAXIMUM - 25)				
NAME OR ROSTER OF PERSON RUNNING THE COURSE		NAME AND GRADE OF SCORER		

DA FORM 1770-R, 1 Aug 71

PREVIOUS EDITION OF THIS FORM IS OBSOLETE.

Figure 134. Bayonet target scoresheet (DA Form 1770-R). (Locally reproduced.)

BAYONET TARGET SCORESHEET		DATE		
For use of this form, see FM 21 - 150; the proponent agency is U. S. Continental Army Command.		1 JAN 76		
TARGET POST NUMBER	TYPE OF TARGET (i. e., Parry Thrust, Vertical Butt Stroke, etc.)			
4	PARRY THRUST			
ELEMENT	POOR	GOOD	EXCELLENT	GRADE
1. DID MAN ATTACK A VULNERABLE PART OF TARGET? (TOTAL POSSIBLE POINTS-3)	0	1	3	3
2. DID HE SELECT PROPER MOVEMENT TO ATTACK TARGET AT THIS POST? (TOTAL POSSIBLE POINTS - 5)	0	3	5	5
3. DID HE EXECUTE MOVEMENT PROPERLY (MAINTAINING HIS BALANCE AND SPEED)? (TOTAL POSSIBLE POINTS-7)	0	5	7	5
4. DID HE DISABLE HIS OPPONENT? (TOTAL POSSIBLE POINTS-5)	0	3	5	3
5. DID HE AGGRESSIVELY CONTINUE HIS ASSAULT TO NEXT POST? (TOTAL POSSIBLE POINTS - 5)	0	3	5	3
TOTAL (MAXIMUM - 25)	0	15	25	19
NAME OR ROSTER OF PERSON RUNNING THE COURSE		NAME AND GRADE OF SCORER		
# 96		ROGERS, R. 1/LT		

DA FORM 1770-R, 1 Aug 71

PREVIOUS EDITION OF THIS FORM IS OBSOLETE.

Figure 184—Continued.

BAYONET COURSE QUALIFICATION SCORESHEET			DATE
For use of this form see FM 21-150; the proponent agency is U. S. Continental Army Command.			1 JAN. 1970
LAST NAME DOE	FIRST JOHN	MI A.	ROSTER NO. 96
LANE NUMBER 2	ORDER NUMBER 8	UNIT A 1/66	SCORE
1. PARRY THRUST			21
2. PARRY BUTT STROKE TO GROIN			21
3. PRONE TARGET IN CRATER			25
4. PARRY BUTT STROKE TO HEAD			19
5. PARRY THRUST			22
6. PARRY RIGHT THRUST			23
7. PARRY BUTT STROKE TO GROIN			20
8. THRUST			25
TOTAL			176
NAME AND GRADE OF SCORER ROGERS R. 1/LT			87.5%

DA FORM 3751-R, 1 Aug 71

Figure 155. Bayonet course qualification scoresheet. (Locally reproduced.)

BAYONET COURSE QUALIFICATION SCORESHEET			DATE
For use of this form see FM 21-150; the proponent agency is U. S. Continental Army Command.			
LAST NAME	FIRST	MI	ROSTER NO.
LANE NUMBER	ORDER NUMBER	UNIT	SCORE
1. PARRY THRUST			
2. PARRY BUTT STROKE TO GROIN			
3. PRONE TARGET IN CRATER			
4. PARRY BUTT STROKE TO HEAD			
5. PARRY THRUST			
6. PARRY RIGHT THRUST			
7. PARRY BUTT STROKE TO GROIN			
8. THRUST			
TOTAL			
NAME AND GRADE OF SCORER			

DA FORM 3751-R, 1 Aug 71

Figure 185—Continued.

LANE SCORER'S RECORD FOR BAYONET TEST

For use of this form, see FM 21-150, the proponent agency in U.S. Continental Army Command.

LANE #		TARGET #		NAME			
ORDER	SCORE	ORDER	SCORE	ORDER	SCORE	ORDER	SCORE
1		18		35		52	
2		19		36		53	
3		20		37		54	
4		21		38		55	
5		22		39		56	
6		23		40		57	
7		24		41		58	
8		25		42		59	
9		26		43		60	
10		27		44		61	
11		28		45		62	
12		29		46		63	
13		30		47		64	
14		31		48		65	
15		32		49		66	
16		33		50		67	
17		34		51		68	

DA FORM 3752-R, 1 Aug 71

Figure 136. Lane scorer's record for bayonet test. (Locally reproduced.)

LANE SCORER'S RECORD FOR BAYONET TEST

For use of this form, see FM 21-150, the proponent agency in U.S. Continental Army Command.

LANE #		TARGET #		NAME			
2		5		Jones, F.B. Psgt.			
ORDER	SCORE	ORDER	SCORE	ORDER	SCORE	ORDER	SCORE
1	20	18	25	35	19	52	23
2	17	19	25	36	25	53	23
3	20	20	23	37	25	54	20
4	15	21	20	38	20	55	21
5	19	22	21	39	21	56	25
6	18	23	19	40	21	57	25
7	25	24	25	41	18	58	24
8	22	25	25	42	25	59	25
9	25	26	25	43	19	60	20
10	24	27	23	44	23	61	18
11	20	28	24	45	23	62	24
12	17	29	21	46	22	63	24
13	25	30	25	47	23	64	19
14	25	31	25	48	19	65	20
15	20	32	25	49	19	66	22
16	23	33	23	50	20	67	23
17	18	34	20	51	25	68	24

DA FORM 3752-R, 1 Aug 71

Figure 136—Continued.

This Page Intentionally Left Blank

INDEX

	Par. graph	Page		Paragraph	Page
Advanced hand-to-hand training:			Smash -----	9	4
Bayonet disarming:			Thrust -----	9	4
Overleg counter -----	115	93	Crossover -----	8	3
Pull and push counter -----	114	89	Defense:		
Somersault counter -----	116	93	Block -----	10	8
Falls:			Parry -----	10	8
Advanced falling -----	105	83	Followup movements -----	12	16
Left side fall position -----	100	78	Modified movements -----	11	14
Practicing falls -----	101, 102	78, 79	Whirl -----	8	3
	104, 105	79, 83	Fighting positions:		
Rear fall position -----	103	79	Attack -----	6	2
Right side fall position -----	99	77	Relax -----	6	2
Front guard position -----	97	77	Fighting principles -----	3, 4	1, 2
Knife attack and defense:			Fix, unfix bayonets -----	18	23
Attack from the rear -----	122	95	Parries -----	93	73
Frontal attack -----	121	95	Training:		
Grip -----	118	94	Commands -----	16	23
Knife attack defense -----	123	96	Continuation -----	26	25
Modified stance -----	120	95	Control -----	23	24
Stance -----	119	94	Facilities:		
Takedowns, throws:			Multipurpose target -----	15	19
Body block -----	109	85	Training count -----	14	19
Front leg takedown -----	111	87	Pugil -----	27,	29
Hip throws -----	106	83	Safety -----	25	25
One arm takedown -----	112	89	Sequence -----	22	24
Overhead throw -----	108	84	Supervision -----	24	25
Overshoulder throw -----	110	86	Formations -----	17	23
Shoulder throw -----	107	83	Uses -----	2	1
Training -----	96	77	Warmup exercises -----	19	24
Basic hand-to-hand training:			Hand-to-hand combat:		
Aggressive action -----	66	51	History of -----	42	43
Cross-hock takedown -----	78	59	Principles -----	43	44
Football kick -----	74	57	Hand-to-hand training:		
Foot stomp -----	75	57	Advanced -----	54	48
Glide -----	69	52	Basic -----	54	48
Guard positions -----	68	51	Commands -----	60	49
Heel stomp -----	73	57	Exercise -----	61	49
Kicks and stomps -----	70	55	Formations -----	59	49
Knee lift -----	76	58	Safety -----	57	48
Pivot kick -----	72	55	The instructor -----	56	48
Purpose -----	64	51	Training pit -----	62	50
Rear strangle takedown -----	80	61	Knife attack defenses -----	94	74
Rear takedown -----	81	62	Pugil training:		
Side kick -----	71	55	Attack course, human -----	34	32
Takedowns -----	77	59	Control -----	32	31
Countermovements:			Equipment:		
Backward roll -----	86	66	Groin -----	38	38
Counter to front body hold, arms pinned -----	90	71	Hand -----	39	39
Counter to front hold under arms -----	91	71	Headgear -----	37	33
Counter to kicks -----	92	72	Stick -----	40	39
Counter to rear hold, arms free -----	88	67	Graded bouts -----	31	31
Counter to rear hold, arms pinned -----	87	66	Target course, human -----	33	32
Counter to rear strangle hold -----	89	67	Value -----	28	29
Finger jab -----	84	66	Warmup round -----	30	31
Bayonet:			Specialized skills:		
Fighting movements:			Holds and counters to holds:		
Attack:			Counter to a two-hand grip on one wrist -----	137	110
Butt stroke -----	9	4	Counter to an overhand grip on both wrists -----	138	111
Slash -----	9	4	Counter to choke hold -----	134	107

	Paragraph	Page		Paragraph	Page
Cross collar strangle hold -----	129	104	Search with pistol, lean-to-		
Double wristlock -----	132	106	method -----	156	126
Front strangle hold -----	127	103	Search with pistol, standing		
Full nelson -----	130	105	method -----	157	126
Hammerlock -----	131	105	Shoelace tie -----	161	128
Leg lift counter to rear			Stick gag -----	165	130
underarm body hold -----	141	114	Sentry silencing:		
Lift counter to rear under-			Helmet neck break -----	146	119
arm body hold -----	140	114	Helmet smash -----	147	119
Overhead counter to rear			One-hand strangle loop -----	148	119
body hold, arms pinned -----	139	112	Other methods -----	150	120
Push-pull counter to front			Two-hand strangle loop -----	149	119
underarm hold -----	136	109	Variations to throws and		
Side collar strangle hold -----	128	103	takedowns:		
Throw counter to front hold,			Front throw -----	142	116
arms pinned -----	135	108	Variations of the hip throw --	144	118
Prisoner searching-securing:			Variations of the over-		
Adhesive tape gag -----	166	130	shoulder throw -----	143	116
Belt tie -----	160	127	Vulnerable points of the body:		
Handkerchief tie -----	164	130	Head and neck -----	48	45
Hog tie -----	163	130	Limbs -----	50	46
Lead tie -----	162	128	Trunk -----	49	45
Search rules -----	152	125	Weapons, natural:		
Search technique -----	153	125	Feet -----	53	46
Securing, gagging prisoners --	159	127	Fists -----	53	46
Searching more than one			Hand held:		
prisoner -----	158	126	Entrenching tool -----	52	46
Search with rifle, kneeling			Helmet -----	52	46
method -----	155	126	Sand or dirt -----	52	46
Search with rifle, prone			Web equipment -----	52	46
method -----	154	125	Hands -----	53	46