

ditioned
350
56J1m
1911

UC SOUTHERN REGIONAL LIBRARY FACILITY



G 000 005 595 4

THE MAKING OF A MECHANICAL OPTICIAN



THE LIBRARY
OF
THE UNIVERSITY
OF CALIFORNIA
LOS ANGELES



THE MAKING OF A MECHANICAL OPTICIAN

A TREATISE ON THE EQUIPMENT
AND MECHANICAL WORK OF
OPTOMETRISTS AND OPTICIANS

By W. W. SLADE

OF THE GLOBE OPTICAL CO., BOSTON, MASS.

OVER TWO HUNDRED ILLUSTRATIONS



PUBLISHED BY
THE KEYSTONE PUBLISHING COMPANY
PHILADELPHIA, U.S.A.

COPYRIGHT, 1911, BY
THE KEYSTONE PUBLISHING CO.

Cur
WV
300
5.2.7
70

CONTENTS

CHAPTER I	
Selecting, Installing and Operating the Machinery.....	1
CHAPTER II	
Care of Machinery.....	11
CHAPTER III	
Lenses—Marking and Cutting.....	18
CHAPTER IV	
Marking Prisms.....	26
CHAPTER V	
Marking Prisms—Continued.....	38
CHAPTER VI	
Cutting Complicated Lenses.....	53
CHAPTER VII	
Lens Grinding.....	62
CHAPTER VIII	
Drilling	75
CHAPTER IX	
Mounting	87
CHAPTER X	
Bifocals	103
CHAPTER XI	
Bridge Bending and Truing.....	123
CHAPTER XII	
Surface Grinding.....	131
CHAPTER XIII	
Surface Grinding—Continued.....	140
CHAPTER XIV	
Surface Grinding—Continued.....	146
CHAPTER XV	
Soldering and Repairing.....	154
CHAPTER XVI	
Soldering and Repairing—Continued.....	161
CHAPTER XVII	
Soldering and Repairing—Continued.....	167

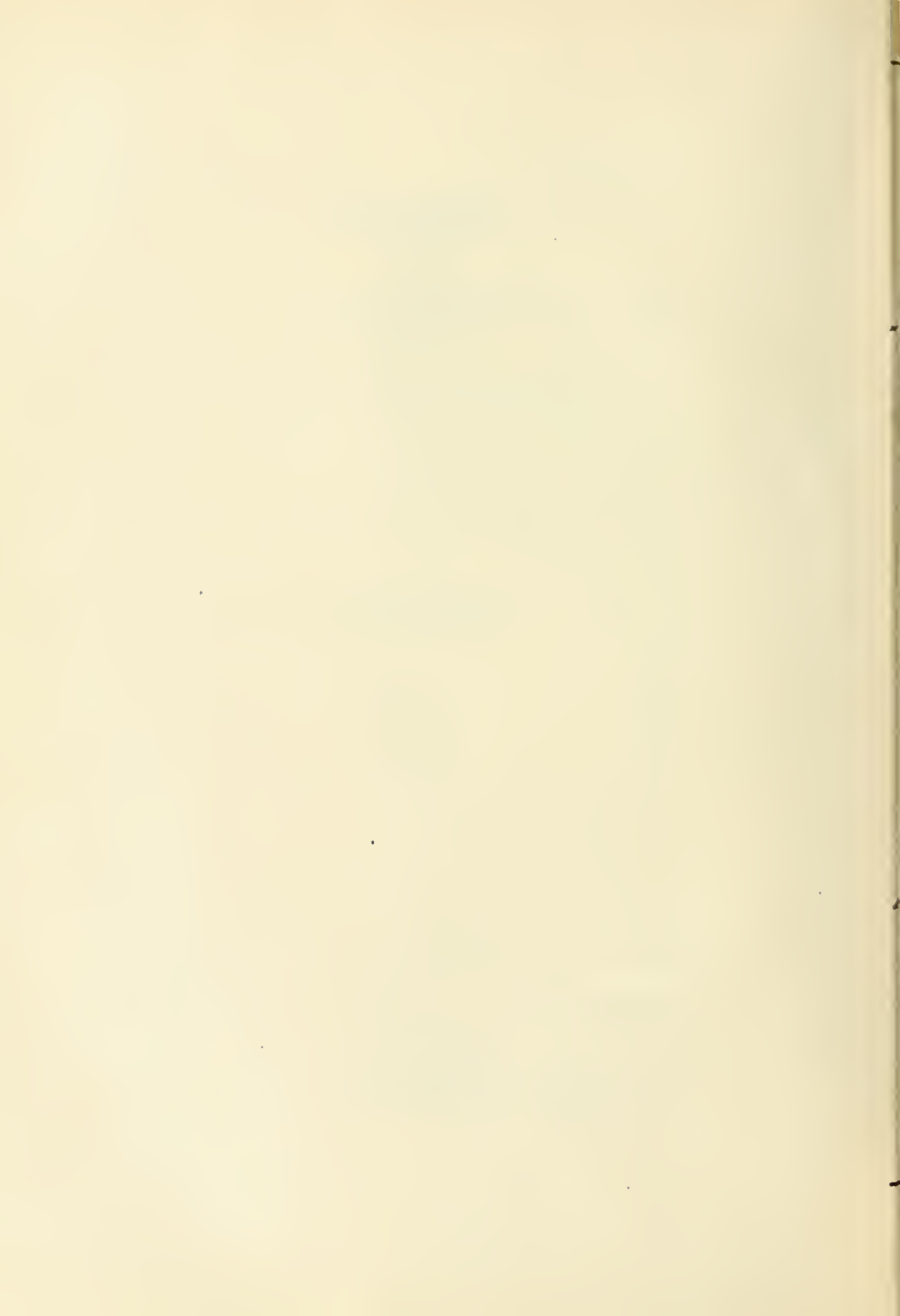

THE MAKING OF A MECHANICAL OPTICIAN

CHAPTER I

SELECTING, INSTALLING AND OPERATING THE MACHINERY

In beginning this treatise we have in mind partially the optician who is considering the advisability of installing a plant to do his own work, and, naturally, the first question to decide is whether it is advisable to install such a plant. The arguments in favor of doing so are the following: The accommodation to your customer, the new customers it will bring by advertising that you do your own work and the extra profit. The arguments against it are: The extra responsibility and labor it will put upon you; have you enough prescription work to make it an object, and if so, can you afford to hire a man, and would it not be advisable to use the time that you would put into this work to develop your refracting business?

This matter you can best decide for yourself, but, assuming that you decide to take the step, the next thing is to lay the plans for your shop and select the machinery.

It was formerly the custom to engage an attic room in some old building on a side street, order a grindstone and engage carpenters and machinists to fit it up. As it was impossible to estimate the expense, it frequently was exorbitant. Now that has all changed, as it is possible to purchase an entire outfit, ready to run, at a nominal cost. This not only saves a great deal of worry, but you can figure the cost almost to a cent.

Another great advantage is that the outfit, sold by the wholesalers to-day, can be used in any office, even with a rug on the floor, and can be kept as clean as a piece of furniture.

The best place for a bench depends somewhat on the circumstances. Some prefer to have an extra room for this work; others fit up part of the refracting room or the reception room. If you have an office, consisting of only one room, you can perhaps select a corner near a window, and, if you prefer, you can stand a screen in front of it. If you have a store, it will be a good idea to place the bench in a prominent position, even in the window, if possible,

thus enabling you to take advantage of the advertising possibilities. This question of space and location, however, is not of very much importance, as there are benches on the market that require very little room.

Having well considered these facts, we now proceed to select the outfit. This is a matter which should be given considerable attention. It certainly is false economy to buy cheap machinery, as it not only gives trouble, but wears out sooner and has to be replaced in a few years. With the best, a great deal of work is done automatically, requiring less time and attention, and one does not need to be an expert to do good work. If you are not limited as to space, we would suggest a bench 4 ft. long by 32 in. wide. This will give you sufficient room to lay out your work, so that you can handle it easily.

After deciding on the bench, the next thing is to select the frameless machine. The four most prominent on the market are the Acme, Gem, Monarch and Simplex. The Acme is a large machine, with a stone 24 in. in diameter and $1\frac{1}{2}$ in. face. It is designed to do heavy work and can be used for both prescription and stock grinding. By this we mean grinding up quantities of interchangeable sphericals and cylinders. The Gem is a medium-sized machine, designed more especially for prescription work, but stock can be ground on it also, but not in such large quantities. It has a composition stone, 18 in. diameter by 2 in. face, and it has been very popular with the shop men for several reasons. In the first place, it is very simple and can be taken apart and put together very easily. It also has a hand wheel for turning the lenses, which is very convenient when in a hurry, to grind off any bunches on the lens, if not properly cut. The Acme and Simplex have a hand wheel for the same purpose.

The "Monarch" is a machine of medium size, not as large as the Gem or as small as the Simplex. It has a 16-inch composition stone with either $1\frac{1}{4}$ or $1\frac{1}{2}$ -inch face and requires only a quarter or a sixth h. p. to operate. This machine will edge from one single lens to as many as will occupy the width of the stone, all lenses being constantly kept on the stone. The stone can be tipped back out of the trough when desired. The machine can be used on the bench or separately with stand or legs.

Whichever machine you decide on be sure to get a composition stone, as a Craigleith requires constant care and never works

as satisfactorily. These composition stones are very hard, and will keep in shape sometimes for years. Either size is all right for hand work. We might state that it is really better to have a separate stone for hand work, as it enables you to keep your frameless machine in better condition. In grinding over a machine the water runs off the hands on to the machine. This is



Fig. 1—Reception room and modern workbench

full of grit, and unless you clean the machine every day it will soon become gummed up and in time refuse to work. If you install the Simplex, however, you should have an extra stone, which can be obtained for about fifteen dollars. The Simplex is designed particularly for prescription work. The stone is but 10 in. diameter and 1 in. face. The machine, however, is built just as heavy as the large ones, and particular attention has

been given to the wearing qualities. The idea of using this small stone is to take up less space and to require less power (a 1/6 h. p. motor will operate it), and then the stone can be replaced at a small cost. Another advantage is in case of repairs it can be boxed easily and shipped to the factory at a small expense. This will be appreciated by anyone having had occasion to renew broken parts or turn up a stone on a large machine. Frequently it has been necessary to pay a man's expenses from the factory or jobbing house to do this work, or if the machine has to be sent to the factory it must be crated and shipped by freight.

The selection of one of these machines will depend on the circumstances and requirements of your work. It should, however, be placed at the right hand end of your bench, as you will find it more convenient. There are many good drills on the market, and samples of these can be seen at all the large jobbers, or a good idea of them can be obtained by consulting the different catalogues. You can obtain a low-priced diamond drill, without a centering device, that does excellent work, but requires more experience in centering the lenses. There is a separate centering device on the market that can be obtained for a small sum. Opticians having old-style drills will find this a great convenience in marking lenses for drilling, as it centers them instantly and accurately. It also has a scale for drilling above and below center.

If you can afford it, we should recommend a drill with the centering device and also an arrangement for drilling torics, such as the Universal (Standard Optical Company's) or the American Optical Company's drill. You should, by all means, use a diamond point, although these are not guaranteed. With a little instruction and by using care you will seldom break one. In selecting the diamond we would recommend a white splint, as this has a rough point and cuts faster. It also can be sharpened at less expense. If you break it, you can replace it for about five dollars. The turned diamond can be had in white stones or black carbon, and these cost from twelve to eighteen dollars. These are, perhaps, less liable to break, but do not cut as fast. (In reality, they grind a hole.) They cost more to sharpen, besides having to be done oftener.

Next is the cutter, and this should be placed on a square board, so that it can be moved back out of the way when not in use.

There are only four on the market, which are used to any great extent, and these are: The American Optical Company; Little Gem (Bausch & Lomb Optical Company); Standard and Globe. The American Optical Company's is arranged so that most of the different shapes and sizes can be cut by adjusting the micrometer head according to a scale furnished with the machine. The Standard is operated by one large pattern with a groove in the under side. In place of a micrometer there is a five-sided barrel with

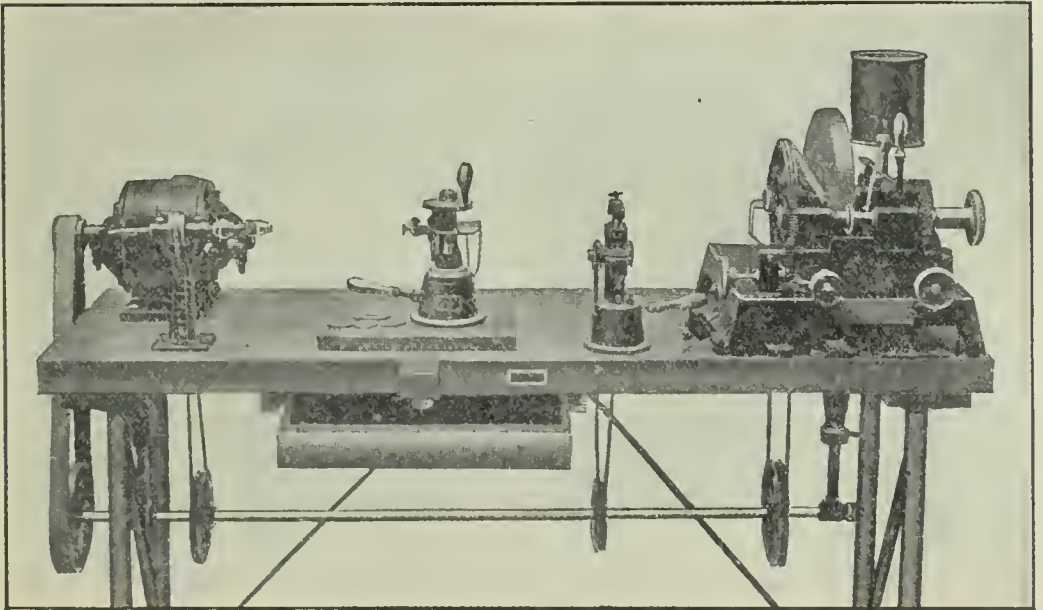

Fig. 2—A modern optician's workbench

the two rolls that run in the groove in the pattern arranged at different distances, so that by turning it you can cut the shapes, having a difference between the length and width of ten, nine, eight, seven and six millimeters. This machine is furnished with a steel wheel, but it can be obtained with a diamond, by paying extra.

The little Gem has an adjustable pattern, and by adjusting both the pattern and micrometer head, according to a chart furnished with it, you can cut most all the ovals. While this scale

is nearly right, we would suggest that you make a scale of your own, for the regular shapes, for accurate work. This can be done by cutting old lenses and measuring them until you find just the right amount to allow for grinding. The Globe is arranged by a series of patterns, so that it will cut any size or shape. These are changed instantly by lifting the top gear. It has a micrometer, arranged with a pointer, so that the frameless sizes are read in millimeters, and the frame sizes in the regular way, 1, 0, 00, etc. This scale is also arranged so that it is set for regular and full eye, without any difficulty, and without consulting a chart. To cut a lens 40 x 33, subtract the width from the length (this is seven millimeters). By placing No. 7 pattern in the machine and setting the pointer at 40 mm., you get the required size. These patterns also interchange with those on Acme and Simplex machines. This you will find very convenient.

Just here we will put in a word about diamonds. Quite frequently we hear that someone wants a cutting diamond sharpened. This is impossible, as a cutting stone is a natural formation, and although it can be reset many times, it cannot be sharpened. In resetting, the stone is taken out of the mounting, and reset at a different angle. These stones have from one to four cutting points, and after it has been reset two or three times, using the same point, it is then necessary to find a new point. Drills are made of splints, which are obtained by cleaving large stones, or from natural stones, sharpened or lapped, by hand. These can be resharpened a number of times, and should be kept sharp to do quick work. The bench should be equipped with a buff-head, having a taper screw and chuck, for small drills, burrs, polishing wheels, etc. As these are not furnished with the outfit, and they must be selected separately, we would recommend the following: About six small twist drills, of different sizes, including the size for frameless glass screws and stud screws; two sizes of solder burrs, for burring out eye wire after soldering; two sizes of temple burrs for burring the joints of temples; a brush wheel; a felt wheel, about three or four inches diameter, will do; a cotton wheel, about six inches diameter. This outfit will do all the work you are required to do.

Next is the motor, and the first thing to do is to inquire of the power company what the current is. It probably will be either direct, 110 volts, or alternating, 110 volts, 60 cycles, and in asking

for quotation, or ordering an outfit from the jobber, be sure and give this information, as it makes about twelve or fifteen dollars' difference in price. All quotations are given with direct current, and the alternating costs extra. If you have a direct current, a $\frac{1}{4}$ h. p. shunt-wound motor should be used. This maintains its speed without the load, while a series-wound will speed up and the load must be kept on to hold it down. You should see that you get a quiet one, as a magnetic hum is very disagreeable. There is

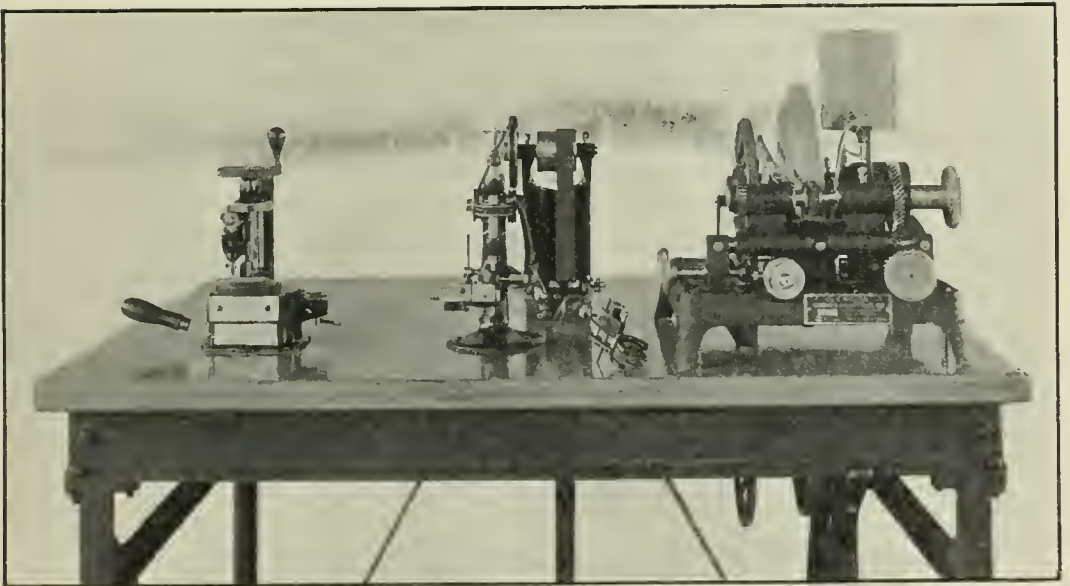

Fig. 3—Outfit for prescription work

a rheostat, or starting box, furnished with it, and if the outfit is bought complete it will be wired up on the bench with a switch and cut-out. It is only necessary then for the electrician to connect the wires, and you are ready to start.

If you have alternating current, we should recommend an automatic starting, $\frac{1}{4}$ h. p. This requires no starting box, which is quite large for this current, and is also started quicker. In buying a motor, the speed is an important matter, and many of the shops that have been fitted up by opticians themselves are equipped with high-speed motors. These have been installed, either from

inexperience, or on account of the low price. A slow speed motor runs with less noise and there is less slipping of the belts. Then again you do not require such large pulleys. They are, of course, higher in price, but are worth the difference. In belting up the motor, an endless belt should be used, so there will be no pounding of the lacing and no vibration. This is very important, if you want a smooth running outfit.

We have now given you a general idea of the outfit, and we think you will see that it is a great deal better to purchase this complete and obtain the benefit of the experience of the optical machinery manufacturers. They have made a study of shop troubles, and have succeeded in eliminating many of them. Occasionally you find an optician who has built his own bench, with the idea of saving money, but in the end he finds it has cost more than any first-class outfit on the market.

Now in regard to tools. These, of course, are not furnished. You will need the following: A pair of breaking tongs, cribbers, a hand-diamond, a set of the brass patterns for cutting odd lenses, round-nose pliers, snipe-nose pliers, optician's hollow chop pliers; flat-nose pliers, strap pliers, angling pliers, cutting pliers (and as there are plenty of special pliers on the market we would suggest looking them over and getting a few of the best ones); an assortment of files, including rat-tail; a millimeter rule; broaches, drilling fluid, bifocal cement and polishing material.

This covers most of the necessary tools, and can be added to as occasion requires. When the outfit comes to you, it will be crated, and after it is opened up, set in place and connected with the current, it should be wiped up to take off the grease which is put on to keep it from rusting in transit. Then look at the bearings, especially the boxes on the stone and main shaft. These may have been set up tight in shipping. If so, the screws should be loosened a little until they turn freely.

Everything should then be well oiled and then the motor can be started. It should be run a few hours, feeling the bearings occasionally to see that they do not warm up. If so, they should be loosened up a little more. Possibly the belts may be a little loose, and even if they are all right at first they will have to be shortened later, as all new belts will stretch. If the motor is a good one it will have an adjustable base, so that it can be adjusted to take up the slack. After taking up all you can in this way, have

a piece taken out at some belt manufacturer's, and do not attempt to lace it. All other flat belts will be laced, however, and these you can take up yourself, but always use light, thin lacings to make it run as smoothly as possible. The round belts will probably be put together with hooks, and they will require shortening very often. In shortening belts do not get them too tight; it is better to run them a little loose, and if they slip it is probably because they are too hard and dry. By applying a little castor oil, occasionally, on the inside, while it is running, it will make them soft and pliable. Never use resin or anything of that nature.

After everything is running smoothly, you can then put water on the stone and place some thick lenses in the machine and allow them to grind a while. In starting a new composition stone, it will absorb the water very quickly, and for the first hour or so watch it carefully and see that it does not run dry, as this will rough it up and may require turning. The stone can be kept wet by a drip, either from a tank, or it can be connected with the water supply, but you should then arrange for the outlet, or it is liable to overflow. A very popular way is to have a sponge pan on the back, filled with water, and the sponge will act as a wick, keeping just enough water on the stone. Some of the machines are supplied with this sponge pan and we recommend this method, as it is much cleaner. Some of the stones, shipped from the factory, are not quite ready to grind on, but by running thick lenses in the machine for a while it will smooth up very quickly. If it does not, a piece of the same material, held by the hand, will polish it.

All the frameless machines are equipped with truing devices, and it is well to true the stone up every little while to keep it in perfect condition, rather than allow it to get badly out, as it is then quite a job to get it back. All that is necessary to do is to set the truing device up until the carborundum stone just touches the grindstone and allow it to run a few minutes until you cannot hear it grind. As the stone oscillates it trues itself automatically. If your stone, for any reason, should get badly out of true, you should turn it with a carbon or black diamond, or you can use the new tool on the market similar to a carbon. This is placed in the truing device and operated the same as the carborundum block. After you have turned it true, it will be very rough; then by replacing the carborundum you can smooth it, the same as before described.

We will describe the use of the drill and cutter later, but they can be tried, and if they do not suit have them exchanged at once, as they are not guaranteed. Do not spoil them and then claim they were never right. If you do not get good results in cutting, it is probably because you have not used just the right pressure. Start lightly, and on each lens gradually increase the pressure until you get a good clean cut.

The cost of operating is trifling, as a $\frac{1}{4}$ h. p. motor uses very little current, costing not over one dollar a month.

The illustrations shown on the preceding pages will give an idea of the arrangement of the benches most in use.

CHAPTER II

CARE OF MACHINERY

Machinery may have the best of care, but it needs a thorough overhauling about once a year. Many opticians, especially those having the new style benches, are very particular to keep them clean, and, although their intentions are good, this is often the cause of trouble. A machine that is running constantly in water needs considerable oil, and although a machine covered with grease does not look very neat, it is really the most practical. If the machine is not wiped carefully the water and grit are deposited on the metal, which causes it to rust or bind very quickly.

The proper method for the care of a frameless machine is to wipe off carefully the water and grindstone grit, but see that it is pretty well covered with oil. All machines are supplied with oil cups, and these, if kept well filled, will take care of the bearings to a certain extent, but all bright parts exposed should be well oiled also. This includes the gears, shafts and all working parts. The grindstone grit, which is a mixture of glass and stone, is partly the cause of trouble and allowing the bearings or shafts to run dry is usually responsible for the rest.

A machine that has the best of care will, after a time, run hard, and as soon as this is noticed it should be taken apart and the trouble located. The first symptom is that a great deal of spring tension is needed to hold the lenses against the stone. This may be noticed on account of the lenses not grinding very quickly, or that the lenses have a tendency to pull away from the stone. If, for any reason, this may have escaped the operator's attention, the machine will gradually get worse, and suddenly it will pull back and forth from the stone. This will cause the lenses to slip, and possibly to chip or break. This motion is caused by friction and, by studying the transmission a moment, it is easily understood. The shaft or belt, whichever way the machine may be constructed, is arranged so the lower shaft turns in the opposite direction to the stone, and the small gears on this shaft mesh with the larger ones on the upper shafts. The upper shafts must neces-

sarily revolve in the opposite direction from the lower shafts, or toward the stone. If there is friction anywhere on the lower shaft it has a tendency to cause the upper shafts to revolve in the same direction as the lower, and, consequently, it turns as far as the spring will allow it, and then jumps backward.

The first step is to locate which shaft is the cause of the trouble. By removing the small gear on the left side of the lower shaft, it will leave the upper one on the left free. As this particular one has either a ball bearing or a cone bearing, there may be trouble at this point. If the difficulty is located in this shaft, the remainder of the machine can be turned with the hand wheel. If it turns freely, it will not be necessary to take any more of the machine apart, unless, possibly, you may intend to give the machine a thorough overhauling. The shaft that is the cause of the trouble must be removed and thoroughly cleaned. If it is simply gummed up with grease, this can be removed with kerosene, but if the shaft has been running dry, and this is the most common trouble, it is probably scored so that it binds. A fine grade of emery cloth should be used to smooth it, rubbing it down until it fits easily. Before it is replaced the bearing should be cleaned thoroughly with kerosene and the oil hole or cup cleaned.

A machine may be oiled regularly, but oftentimes the oil becomes gummed, stopping up the oil cup, and yet escapes the attention of the operator. If it is the lower shaft that is causing this trouble, there is nothing more to do to it, but should it be either of the upper shafts, the ball or cone bearings must be looked over carefully. If any of the balls are broken, replace them as soon as possible, although the machine can be run temporarily with one or two missing. If it is a cone bearing, it may have become worn or scored a little and may need to be turned. If the machine is one that has a screw-clamping arrangement for holding the lenses, this will have to be taken apart and looked over carefully; it may be only gummed up or a spring may be broken, which will have to be replaced.

A machine that has been running one year will show little or no wear, but if it has been running for a longer period, the bearings may be considerably worn. In this case they should be fitted with new shafts and bushings, and if one is to have accurate work there can be no great amount of play in the bearings. It

will depend, however, on the machine; if it is so constructed that the pattern is near the lenses, the wear does not make as much difference as if it were placed on the other end of the shaft. If a machine needs repairing, the front part can be removed and shipped to the factory, by express. It is unnecessary to ship the stone, stand, etc., unless one is not mechanically inclined. When it comes to a question of repairs, it is cheaper and better to send it to the factory where it is manufactured, as they have the parts in stock and understand what is required better than some local machinist.

After the machine is in running order again, there are some points which should be looked after to put the machine in first-class condition. The bearings of the stone will probably show signs of wear and, as all the best machines are constructed with split boxes, all that is necessary to do is to tighten the four set screws occasionally, to take up the play (Fig. 4). A bearing

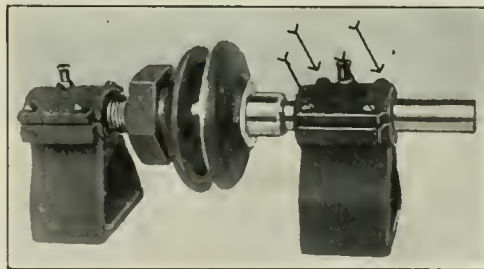

Fig. 4

of this kind is babbitted—that is, it is lined with a composition of soft metal, consisting of lead, tin and antimony. This forms one of the most satisfactory bearings, although not the best or most expensive. The theory is that one soft metal and one hard metal, running together, cause the least friction and the least wear. When a bearing of this description is made, the soft metal is poured, when hot, into the cast-iron box around the shaft, so that it is shaped to it perfectly. It is, however, left a little large, to allow for a “take up” as the bearing wears. After the wear has been taken up as much as possible the boxes must be re-babbitted; this can be done by any local machinist. To obtain

the best results in lens grinding, these bearings should be kept in shape, although they can be run for years with loose boxes without much serious trouble. When the stone is to be turned is where the greatest trouble will be found, as it is impossible to turn it true if there is any "play" in the boxes.

The stone at this time may need turning, possibly on account

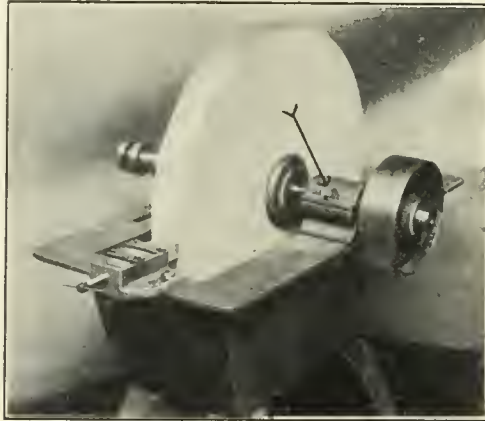

Fig. 5

of ridges near the edges, caused by the lenses not covering the entire surface of the stone. The truing device is supposed to take care of this wear, but this device is usually neglected by most opticians. The correct way is to set this up to the stone every day for a few minutes, to offset the amount of wear caused by the grinding. If it is used only occasionally, it requires quite a little time to put the stone in first-class shape with this device, consequently the most satisfactory way is to turn the surface off squarely with a diamond and then finish it with a truing device. This operation was described earlier in this chapter. If the surface of the stone shows no signs of wear it still may need turning, on account of it being out of round. This will make no great difference in hand grinding, but in machine work it will cause ridges or facets to appear on the edges of the lenses (Fig. 6). When this defect is found, many grinders look for trouble in some part of the machine, but this is always caused by the

stone being out of round. As stated before, it is impossible to turn it perfectly true unless the bearings are in perfect condition.

After a stone has been turned a number of times the gage controlling the size of lenses will need adjusting, to allow for the reducing in size of the stone. Every machine is constructed so that this adjustment is very simple. All that is necessary is to grind a lens with the gage, set at any size, and, when it is finished, measure it accurately with a rule. The gage or pointer should then be loosened and set to this size. By consulting the directions which accompany each machine, anyone can easily set his machine without any difficulty.

The contact block, on which the pattern or former rides, also may show signs of wear. This, as it becomes grooved, will change the shape of the lenses, although they will not be exactly like the patterns used. This makes no particular difference when grinding pairs, but when matching an old lens they will not be alike. On some machines it will be necessary to fit a new plate, and on others the block can be reversed. After both sides are worn a new one then should be fitted.



Fig. 6

We will next turn our attention to the drill. With the usual amount of work in a small shop, this should require very little repairing. The upright spindle will wear for years, but possibly the idler shaft and idlers may have become worn so they rattle. This does no particular harm, except that the noise is objectionable. Any local machine shop can bush these bearings at a slight expense and it is well worth the trouble and expense to eliminate the noise. The centering device may require some attention, as this is operated in grit most of the time. With only a slight amount of wear, this can be taken up in a machine shop or at the factory, but when it gets very loose it is better to exchange the whole machine for a new one, paying, of course, the difference in cost. Any good drill should wear for years, however, before this part will cause trouble. After drilling for six months or a year, the diamond should be repointed. Many are using slow-cutting drills, in ignorance of the fact that they can be sharpened at a slight expense, and these drills not only exhaust the patience, but also may break lenses, on account of the unnecessary pressure required.

The cutter should require no repairing, except possibly the diamond may need resetting. Do not confuse a diamond, used for cutting, with a drill. A drill can be sharpened, but a cutting diamond must have a natural point. In resetting, the stone is

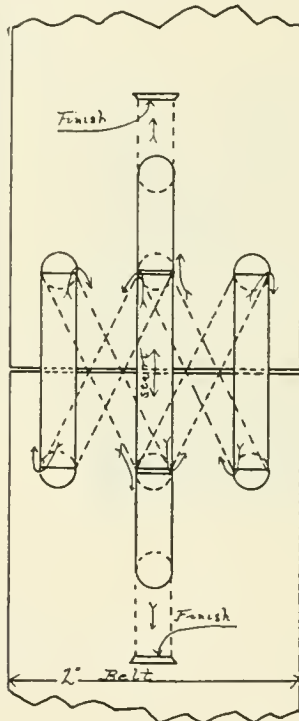

Fig. 7

Showing method of lacing
2-inch belt

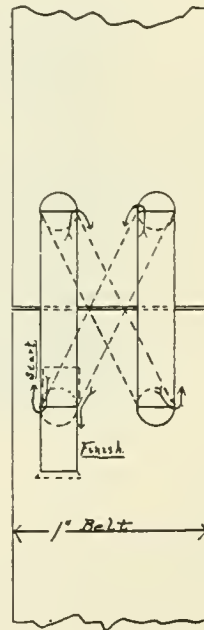

Fig. 8

Showing method of lacing
1-inch belt

taken out and reset at a different angle or so that a new point can be used. When it is necessary to have your diamond reset, send it to your jobber, so that it may be done by one familiar with the requirements of a machine for optical work. A regular diamond-setter may not have had experience in the optical line, consequently the best results are not obtained.

The buff head will probably need to be taken up in the bearings. This is not necessary, except that it may rattle so the noise

is objectionable. This machine is also constructed with split bearings, so they can be taken up.

The motor should require no attention for some time. After a while the carbon brushes will wear down, so that it will be necessary to replace them. These cost but very little and can be obtained from any motor dealer. After some years the part of the armature called the "commutator" will, perhaps, become worn from contact with the brushes. When this is worn to any great extent, it should be sent to a motor repairer, who can turn this off in a lathe. The ordinary care of a motor requires regular oiling and occasionally, in the event of sparking, the commutator can be cleaned or smoothed with a piece of 00 sand paper. Occasionally a little vaseline on the tip of the finger and rubbed on the commutator while running will stop any sparking.

The bearings on the main shaft, and also any countershafts, should be looked over and any wear taken up by tightening the



Fig. 9

set screws. If any belts are slack, they should be tightened. Small flat belts, or those driving the stones, can be laced. There are several methods of connecting, but rawhide lacings are the most satisfactory, as they lie flat and are practically noiseless. Hooks and metal connections make a click, which is objectionable.

In lacing a belt, three small holes should be punched on each end, then two more in a line at a reasonable distance back of them (Fig. 6). The lacing should be thin and passed through the holes as shown in the illustration. Round belts can be connected with steel belt hooks (Fig. 7). When flat belts slip, pour a little castor oil on the inside, while running. Never use any other substance.



Fig. 10

Make it a point to keep your machinery in good running order. To have a noisy shop or outfit shows lack of attention to the small details. It is just as easy to have your machinery run noiselessly, and the impression it will make on your patrons is well worth the trouble.

CHAPTER III

LENSES—MARKING AND CUTTING

In selecting the stock of lenses quite a little capital can be invested, or you can start small and increase it from day to day. A stock varies in price from \$50 to \$500, but the usual amount invested is from \$100 to \$200. This will include principally $+ \text{C}$ $+ \text{C}$ compounds, a few $- \text{C} -$, plano cylinders, oval or round Dcx. and Dcc. sphericals, Pcx. sphericals, regular and plano wafers. If you use large, full eye lenses it will be better to have the sphericals in round, as these will grind 40 mm. or 41 mm. in length and any width. The $+ \text{C} -$ and $- \text{C} +$ compounds, compound wafers and rough cylinders (provided you are to do surface grinding), can be ordered daily, until you can afford to stock them.

Compounds are put up in single envelopes, with the axes dotted, cylinders in packages of half dozen pairs, the axes dotted, and sphericals in the same way, but not dotted. By this you will see that it is better to buy cylinders and sphericals in original packages, although compounds can be ordered three pairs of a number. If you have had no previous experience in ordering, a good plan is to see your jobbers and tell them that you wish to place an order for a quantity of rough lenses, stating the amount you wish to invest, and let them submit lens sheets, showing the assortment and quantities that can be obtained for this figure. As they are constantly making them up, they can best advise you. You can then look it over and change it as you see fit. If you have made no provision for carrying your stock, we would suggest getting an uncut lens cabinet. This is made of oak, with galvanized iron drawers, with wood front and back. The small drawers are partitioned off for compounds and the large for cylinders and sphericals. The latter have pressed paper partitions in front for single lenses, without wrappers, and the surplus is placed in the rear. This can be obtained much cheaper than you can have one made and will last a great many years.

A good way to keep your stock ordered up is to have a box

handy, and as you use the compounds put the envelopes into it and order from them.

In selecting the lenses for a prescription it will be necessary to have a pair of calipers or lens gage, graduated in $1/5$ mm. With this the lenses are calipered in the center, allowing $2/5$ mm. for each diopter. For example, a plano lens is the same thickness on the edge as in the center, and if you wish to make a pair of glasses two-strap thickness, having a plano in one eye and $+ 1$ in the other, we select the plano first 2 mm. thickness and the $+ 1$, $2 \frac{2}{5}$ in the center. If the lens was concave, it would be $1 \frac{3}{5}$ mm. In this way the edges are made the same thickness. In cases where there is to be a compound in one eye and spherical in the other, it is well to look at the compound and use your judgment

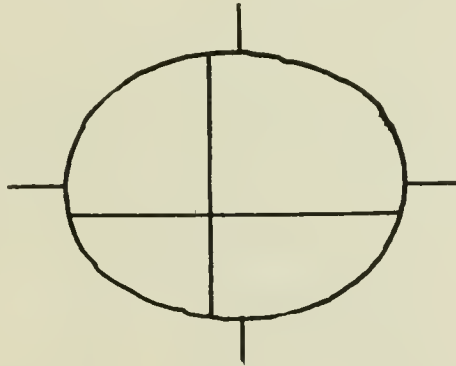

Fig. 11

as to which would be best—a double convex or periscopic. If the compound is $+ \text{C} +$, a Dcx. would make a better match; whereas if it were $+ \text{C} -$, a Pcx. would be nearer the curve.

For marking you will need quite a stiff pen that does not scratch, a bottle of black waterproof ink and a protractor graduated in five degrees. These are furnished by some jobbers, as advertisements, with a decentering scale on the back, which is very convenient. For cross lines use a card about the size of a reading test type, and draw heavy black lines at 90° and 180° . This will be used for medium and strong powers; for the weak powers draw the lines on a wall about twenty feet distant. In marking, first decide which surface will be next the eye and then always mark on this surface. The rule is, the greatest

concavity or the least convexity, next to the eye, always having the cylinders on the same side, except in extreme cases. We will first select a sphere, and all that is necessary in this case is to dot

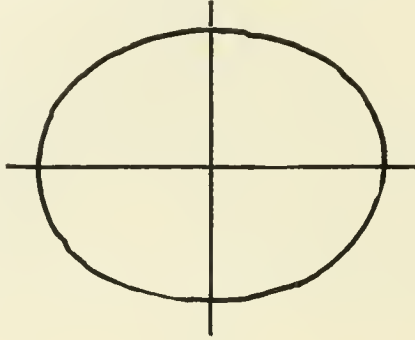

Fig. 12

the center. We find the center by looking through the lens at crossed lines, and the lines will appear broken (Fig. 11).

Then move the lens until the lines are continuous and place a

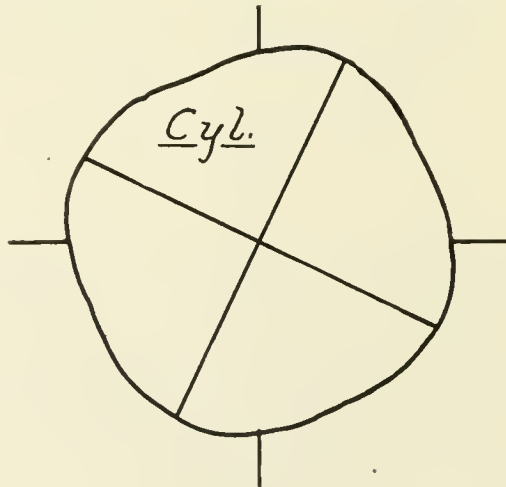

Fig. 13

dot where the lines cross (Fig. 12). A cylinder usually has the axis running from corner to corner, and in lining it up the lines will appear broken and perhaps twisted (Fig. 13). By turning the lens they will line up so that they appear straight and by moving

in a horizontal and vertical position they will be continuous. Then place two dots on the lens, one at the top and one at the bottom. Now lay it on the protractor with these dots at whatever axis the lens is to be cut. Draw a line across the lens at axis 180° . This

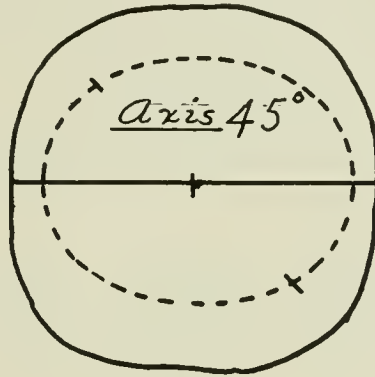

Fig. 14

will be the mechanical axis or cutting line, as it is usually called. Remember that whatever axis is to be cut the cutting line is always drawn at 180° . For example, axis 45° will be placed, as shown in Fig. 14, axis 90° as Fig. 15.

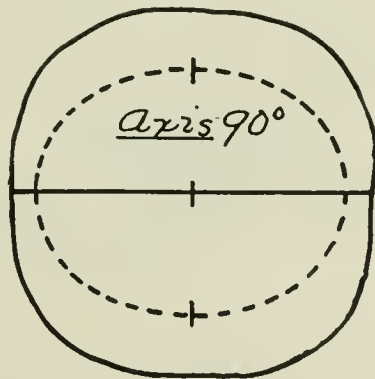

Fig. 15

A compound is lined up in the same way as a cylinder, and the lines will look the same, but when you have it in position three dots must be placed on the lens, one at the top, one at the bottom and one in the center. It is then laid on the protractor the same

way, but be sure that the center dot is on the center of the chart or your lens will be decentered. If you wish to obtain some prismatic power you can decenter it, using the following rule: A lens decentered ten millimeters will produce a prism power of as many diopters as the focus. Thus a + 1 D. lens, decentered 10 mm., will have a prism power of 1 D. By this you will see that a +

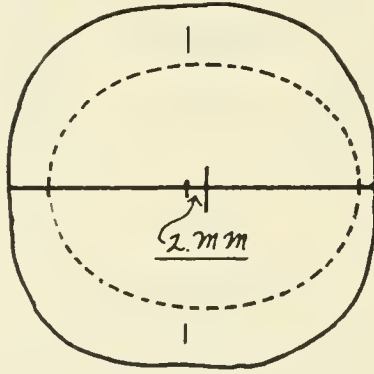

Fig. 16

1 D. lens, decentered, 2.5 mm., would give us $\frac{1}{4}$ D. prism. A mistake is often made, however, in ordering a lens decentered 6 or 8 mm. This cannot be done, as the stock lenses are not large enough. Extra large lenses could be used, but these would cost more than to have a pair surface ground. With the large sizes

$$\begin{array}{c}
 +6.00 = +6.50 \\
 \text{---} \\
 -6.00 \text{ sph} \\
 \text{---} \\
 \underline{+ .50 \text{ Cyl}}
 \end{array}$$

Fig. 17

that are now being used a lens cannot be decentered over 2 mm. In marking a lens to be decentered, it is dotted in the usual way and then moved on the chart the amount necessary and a cross line drawn on the cutting line (Fig. 16). Before the lenses are cut they should be neutralized to be sure the power is correct. If you depend on the lens measure it should be kept accurate by frequent adjusting, and if you do not have two, one for American

Optical Company and one for Bausch & Lomb, you should make an allowance of .03 D. for every diopter. We prefer to use a lens measure, graduated for Bausch & Lomb stock, and then add the required amount when measuring American Optical Company's stock.

Very little can be saved in buying torics uncut, as the responsibility of breaking is too great, but if you prefer to grind these yourself they are handled just the same as flat lenses in marking. We will give a few suggestions for ordering, so that you will be sure to get the best results. If all prescriptions for torics were filled as written a great many would have no toric effect.

You should, of course, understand the transposition of lenses, and transpose them to the best form before sending in the prescription. If you do not you should state that you want the prescription filled in the best form. In ordering plain cylinders it will

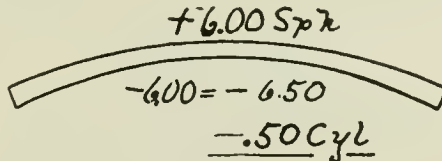

Fig. 18

make no difference which way they are ordered, unless wafers are to be fitted. If a + cylinder was ordered, the lens would be ground as written and would have the cylinder on the outside, and a 6 D. curve on the inside (Fig. 17). If a - cylinder was ordered it would be ground with the cylinder on the inside and a + 6 D. curve on the outside (Fig. 18). If wafers were to be fitted, the cylinder should be on the outside, so that the wafers could be cemented to the inside surface. It would then be necessary to transpose to a compound. For example: A - .50 cylinder, axis 180° , would be - .50 sphere \odot + .50 cylinder, axis 90° . This lens would, of course, cost extra.

The ordering of compounds is a more difficult matter and the optician should know just what surfaces are to be ground. For example: If a + 1 sphere \odot + .50 cylinder, axis 90° , was ordered, it would be ground as written, and the lens would be

+ 6 \odot + 6.50 on the outside and a - 5 sphere on the inside (Fig. 19).

By this you will see that the toric effect has been reduced 1 D. While it does not matter much in this case, the toric effect is

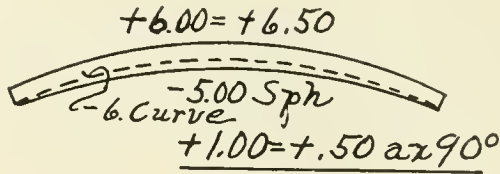

Fig. 19

gradually reduced until with a combination of + 6 sphere \odot + .50 cylinder, axis 90° , it has a plano effect and this would be ground with + 6 \odot + 6.50 on the outside and plano on the inside (Fig. 20).

All + and + combinations with a spherical stronger than + 1 should be transposed. For example: + 3 sphere \odot + 1 cyl-

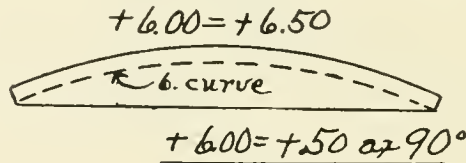

Fig. 20

inder, axis 90° , if ground as written, would have only - 3 D. inside curve. If it is transposed it would be ground with + 10 D. outside and - 6 \odot - 7 inside (Fig. 21). This lens costs more, but will give better satisfaction to your customer. If you

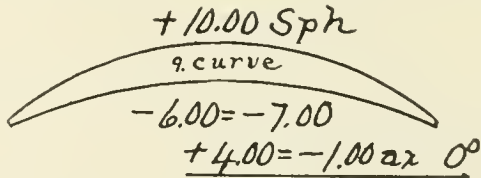

Fig. 21

understand this before ordering you can explain it to your customer and charge more for your lens accordingly. Concave com-

binations are transposed in the same way. When wafers are to be fitted they should be transposed so that the cylinders are on the outside.

In combinations where the spherical power exceeds + 3, the distance lenses should be ordered on a + 9 curve. Thus a combi-

$$\begin{array}{c}
 +9.00 = +10.00 \\
 \text{---} \\
 -6.00 \text{ Sp } \pi \\
 \text{---} \\
 +3.00 = +1.00 \text{ ax } 90^\circ
 \end{array}$$

Fig. 22

nation + 3 sphere \odot + 1 cylinder would be + 9 \odot 10 on the outside and - 6 sphere on the inside (Fig. 22). This gives you the regular - 6 toric effect, and although it increases the expense it makes a much better lens.

CHAPTER IV

MARKING PRISMS

Opticians, as a rule, prefer sending their prism work to the prescription houses; some, however, purchase the lenses uncut and edge them in their own shop. The amount saved is trifling when the risk of breakage is considered; still, many are willing to accept the responsibility. A great deal of care should be used in marking these lenses, especially with cylinder or spherocylinder prisms.

A plano prism must be accurately ground; that is, the power must be perfect, as any decentration cannot change it. When the

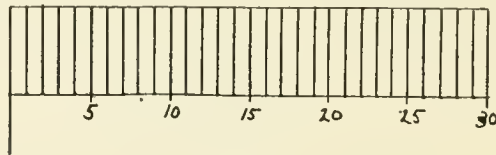

Fig. 23

lens is selected, it is first tested to ascertain if the power is correct, either by using a test prism to neutralize it, or by sighting at a prism chart (Fig. 23). This consists of a series of lines, an equal distance apart, graduated from $\frac{1}{4}^\circ$ to 30° . At whatever distance the chart may be arranged for, the first long line appears to be moved along the chart, indicating the power of the prism that is tested. This method is convenient, but is used only with plano prisms.

A plano prism will appear to throw the line to one side, the same as any lens out of center. When twisting a plano prism, the line does not remain stationary, as with a spherical, or twist, as does a cylinder. The movement appears to move the line to, or away from, the straight line, but always parallel to it. To experiment, take a prism, hold it with the base up or down, and sight at a straight line; this you will find will be continuous. Now turn the prism, and the straight line will move to one side, until a

quarter turn has been made; this will be the extreme point that the line will travel, and will indicate the power of the prism. Now continue in the same direction, until another quarter turn has been made, and you will notice that the line will appear to move back until it is continuous again (Figs. 24, 25, 26). In neutralizing, the test prism is placed against the one to be tested, and when looking at a straight line, it will be continuous.

When marking a plano prism, it is held so that the base will either be upward or downward. We then sight at a straight line in the same manner as a compound, but in order to make the line continuous it must be rotated. Moving the lens sideways will

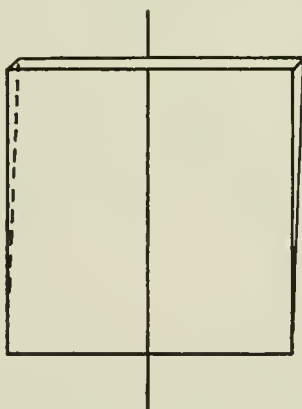

Fig. 24

not change the lens in any respect. If the lines are not continuous, there will be a prism power either base upward or downward, as well as in or out. Having lined up the lens correctly, a mechanical axis or cutting line is drawn from base to apex, provided the lens is to be fitted with the base in or out. If the base is to be up or down, it must be lined up and dotted in the same manner, but the mechanical axis is drawn at right angles. As there is no center on a plano prism, it does not matter whether it is cut in the center of the lens, or near the apex or base, except that the thickness will vary. If a thin lens is desired, it can be cut near the apex, or thin edge; if a thick one, cut it near the base, or thick edge (Fig. 27). The one point to bear in mind is, that the power does not change as you move the pattern by which the lens is cut up or down, in or out, provided it is not twisted.

If a plano prism is twisted, we immediately obtain power in the opposite direction (Fig. 28). A chart is published for the purpose of computing double prisms. This is not only convenient for marking these lenses, but it also tells us the amount of prism

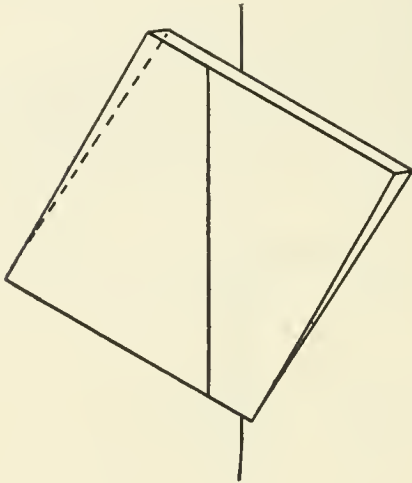

Fig. 25

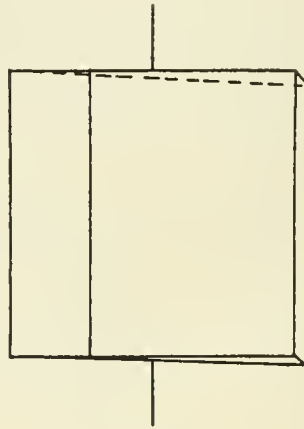

Fig. 26

obtained in both directions, when a prism of any diopter is fitted at any angle other than 90° or 180° . For example, if a 2° prism is fitted at axis 45° , it will have the effect of $1\frac{1}{2}^\circ$ out and $1\frac{1}{2}^\circ$ up; or if the prescription calls for 2° in and 2° up, we can cut a 3° at axis 135° . By this method it will be easily seen that a slight variation will produce a prism power in the opposite direction.

A sphero prism is handled in much the same manner as a plano prism, except that there may possibly be a center on the lens, and this must be considered. A weak spherical with a high power prism will have no center on the lens, whereas a strong spherical with a low power prism will have the center so near the middle of the lens that the prism power can be cut or ground out very easily, and a simple spherical produced. A sphero prism is nothing more or less than a decentered spherical, and by referring to the rule it will be seen that if a spherical lens is decentered it will produce 1° prism power for every 10 mm. decentration. If sphericals were large enough, it would not be necessary to grind

sphero prisms, but to produce the high powers it would require immense blanks. A spherical can be decentered a limited amount, and tables are published by the prescription houses for this purpose (Fig. 29), but it is impossible to decenter any lens much more than 2 mm. Extra large lenses can be used, to be sure, but these also cost extra, so that it is just as cheap to use sphero prisms.

In marking, the lens is lined up the same as a plano prism; that is, with the base up or down, and the mechanical axis drawn as before. It is then turned in the opposite direction, and a test prism held over it, of the required power. A short cross line is then drawn at the center. In cutting, the lens must be placed on the machine so that the cross line comes exactly in the center of the pad, otherwise the prism power will be reduced or increased. By this it will be seen that a sphero prism cannot be treated in the same manner as a plano prism. It is possible, however, to twist or rotate the lens, so as to produce a prismatic power

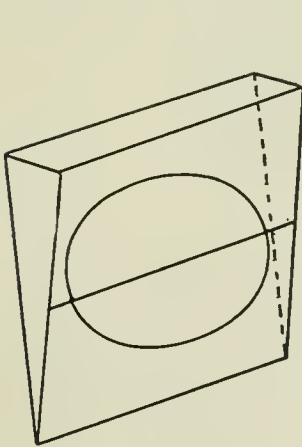

Fig. 27

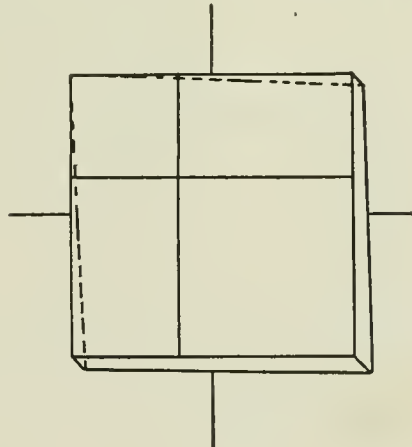

Fig. 28

in the opposite direction, and double prisms can be obtained by the use of the chart, as before described.

A cylinder prism is more difficult to mark, especially if the axis is oblique. Also when the base of prism is at any other point than at vertical or horizontal. For example, we will first select the simplest form, $+ 1$ axis $90 = 1^\circ$ in or out. This lens

will have no power in the vertical meridian, or on the line of the axis. There also should be no prismatic power in this direction if the lens is ground correctly. If there is a prism up or down,

Dioptres	$\frac{1}{4}^{\circ}$	$\frac{1}{2}^{\circ}$	$\frac{3}{4}^{\circ}$	1°	2°
0.50	4.6
0.75	3.
1.00	2.3	4.6
1.25	1.8	3.7	5.5
1.50	1.5	3.1	4.5
1.75	1.3	2.6	3.9	5.3	...
2.00	1.1	2.3	3.4	4.6	...
2.25	1.	2.	3.	4.1	...
2.50	.9	1.8	2.7	3.7	...
2.75	.8	1.7	2.5	3.4	...
3.00	.75	1.5	2.3	3.1	...
3.25	.7	1.4	2.1	2.8	5.7
3.50	.65	1.3	1.9	2.6	5.3
4.00	.6	1.15	1.7	2.3	4.6
4.50	.5	1.	1.5	2.1	4.1
5.00	.45	.9	1.3	1.8	3.7
5.50	.4	.8	1.2	1.7	3.4
6.00	.35	.7	1.1	1.5	3.1

Fig. 29

the lens must be reground, for it cannot be decentered in this meridian, as it has the same effect as a plano prism. In the horizontal meridian this lens has a power of $+ 1$, and by decentering the prism power can be increased or decreased, the amount, of course, depending on the size of the lens to be cut. With a stronger cylinder, the amount could be considerable, so that one can readily see the necessity of accuracy. It must be understood that prism power and decentration are the same; that is, by decentering a lens, we produce prism power. Many opticians seem to have an erroneous idea regarding this matter, as often a customer will object to having prisms ground, and states that he wants decentered lenses. If a prescription is ordered with the lenses decentered in 2 mm., perhaps on account of a narrow P. D.,

a prism is produced in the lenses, although the original idea was to obtain the correct pupillary distance. If this were thoroughly understood by every optician, it would make the work much easier for the prescription houses.

To return to the lens in question, we find that the lens must have no prism power in the vertical meridian. This having found to be correct, we proceed to dot the axis. There are two ways to do this—one is to line up the lens at right angles to the axis, and the other is to place the test prism on the lens to be marked and dot the axis just as if there were no prism on the lens at all. By the first method, we line up the lens so that the line is continuous, and place a dot at each edge. This will be the mechanical axis, or cutting line. This line can then be drawn. We then select a 1° test lens, and hold it over the lens to be marked, and center the lens in this direction, placing a short cross line at the point where the lines intersect. By this it will be seen that if the prism power is weak, the cross line will be moved towards the apex, or thin edge, and if strong, towards the base, or thick edge, which shows that the prism was not accurately ground. It also shows us that a lens ground with a 1° prism could be decentered

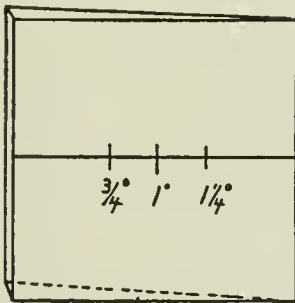

Fig. 30

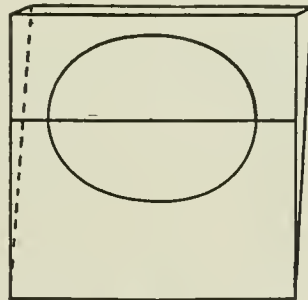

Fig. 31

to produce $\frac{3}{4}^\circ$ or $1\frac{1}{4}^\circ$, although in reality the lens would not be large enough to cut an ordinary size lens, unless the focus was strong enough (Fig. 30).

If the second method is used, the test prism is selected and placed over the lens to be marked, with apex to base, in order to neutralize the prism. We then line up the axis, as with a plano cylinder, dotting it at the edges. It is then laid on a card with

cross lines, and a cutting line or mechanical axis is drawn at right angles to the axis. As there is no center in this meridian, it does not matter where this line is drawn as long as the size of eye can be cut out (Fig. 31).

We will now suppose that the lens was $+ 1$ axis $90 = 1^\circ$ up or down. The cylinder would have no power in the vertical meri-

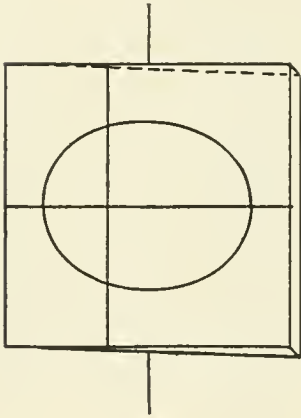

Fig. 32

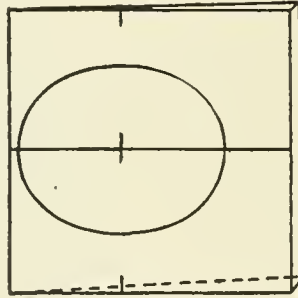

Fig. 33

dian, but would in the horizontal. In this combination, the prism power must be accurate, as there is no possible way to change it by decentration. As there is a cylinder power in the opposite direction, we can produce a prism by decentering the lens in or out (Fig. 32), so that if care is not used we will get a double prism. In marking a lens of this description, either of the two methods before described can be used. We first test it with a prism, to ascertain if the power is correct. The lens will then be lined up on the axis, in the same manner as a plano cylinder. If the lens has been ground inaccurately, so there is a little prism base in or out, the axis dots will come a little to one side. This will not matter, however, as long as the size required can be cut (Fig. 33).

The lens is then placed on the cross lines, and the cutting line drawn at right angles. It is of no consequence whether this line is in the middle of the lens or not, as far as the prism power is concerned, but it will make a difference in the thickness of the lens. If it is cut near the base, it will be thick, and near the apex,

thin. If the lens, when surface-ground, is left full size, it can be cut fairly near the apex, as it will be quite thick enough for the frameless lens. A prism with base up or down can be used considerably thinner than one in or out, for the reason that in the first form the straps are fitted in midway between the base and apex, whereas in the second form one strap, if a spectacle, must be fitted to the apex, or thin edge, and if an eyeglass, the lens can also be used thin, provided the base is in, because there is no strap to be fitted on the thin edge, except possibly a handle, and nowadays these are rarely used.

If the lens is to be marked, using the second method, test the prism power, and line it up at right angles to the axis, placing the dots on the edge. It is then laid on the card and the mechanical axis drawn. We then hold the lens in the hand, and sight at a line; by moving the lens until the line is continuous, we find the center, which in reality is the axis. In both these methods, with the base up or down, it must be remembered that the prism power must be ground accurately, and tested with a test prism before attempting to mark it, as the prism power cannot be changed. With the base in or out, the prism power can be changed slightly by decentration, as described.

Cylinder prisms, with the axes oblique, are more complicated; consequently, are more difficult to mark. If the base of the prism is at 90° or 180° , the prism power is easily neutralized, and the lens is then marked as if it were a plano cylinder. If the prism power is accurately ground, it simplifies the work considerably, as there are no extra conditions to deal with. There are many lenses of this nature in use to-day, that are not correctly ground, and yet they have been marked and cut in ignorance of the fact that there is prism power up or down when not called for on the prescription. Every optician should always take pride in the work he sends out, for when repairs are to be made your customer may take them elsewhere, and as your case bears your name your reputation may suffer. Oculists, who prescribe many prisms, usually understand them, and are quite particular; so it pays to be accurate in this work. A very easy way to handle this work is to scratch the axis on the rough cylinder, before grinding the prism, but this is very apt to cause breakage when heating the glass in blocking. If there is only an occasional lens to be ground,

it is possibly just as well to take a chance, but in the large prescription shops breakage can be quite an item, so these lenses are usually ground without scratching the axis.

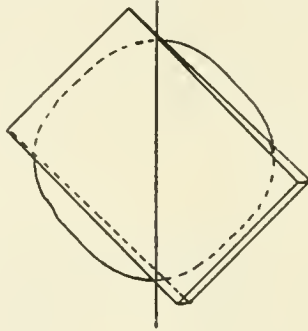

Fig. 34

We will take, for example, $+1$ axis $45 = 1^\circ$ out, and suppose that the prism is accurately ground—select the 1° test prism and place it over the lens to be marked with the apex to base. The prism is then neutralized, and the lens is practically a plano cylinder. Now turn both lenses so the axis can be lined up, which

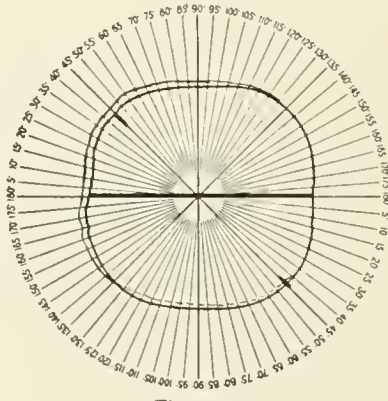

Fig. 35

will bring them cornerwise (Fig. 34), provided the cylinders are ground this way. After dotting the edges remove the test lens, and lay the lens to be marked on the axis card, with the dots at 45° . Then mark the cutting line or mechanical axis in the middle

of the glass, but without a cross line for the center (Fig. 35). Now take the test prism and place it in position as before, and sight at a straight line. This will appear twisted, as in Fig. 36, and if the prism power is correct, the line will be cut top and bottom an equal amount. If the lens is not held in the correct position, or if the prism is not correct, it will be cut more at one end than at the other (Fig. 37). By moving both lenses from side to side, until a point is found where the lines break evenly, a center will be found. If this is at one side of the middle of the lens, the prism power is strong or weak, and if the size cannot be cut, it must be reground and corrected.

In marking cylinder prisms it must be remembered that the lens cannot be twisted, but must be cut as ground, as turning the

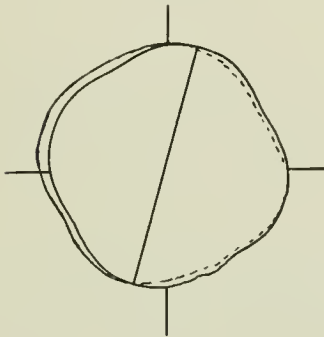

Fig. 36

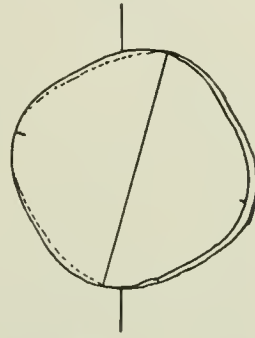

Fig. 37

lens to change the axis turns the prism also, thus making a double prism. Turning the lens to make the prism correct will bring the axis off at the same time.

A cylinder prism with the axis oblique, and the base up or down, is marked in the same way, but care must be used so it is not decentered, thus producing a prism in or out. In all weak power cylinders the decentration, when the axis is oblique, does not amount to very much, and possibly will do no harm to the wearer, but the higher powers require only one or two millimeters decentration, to produce quite a little prism power. With the base in this direction, it is well to cut it as near the apex as possible, and if the center comes fairly low it is all the better (Fig. 38).

When the axis of the cylinder is oblique, and also the base of

prism, it really produces a double prism, and it should be marked as such, unless the prism is at the same axis as the cylinder. For example: $+ 1$ axis $45 = 2^\circ$ axis 45 would be either $+ 1$ axis 45

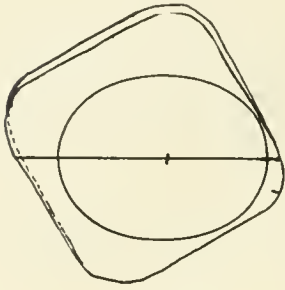

Fig. 38

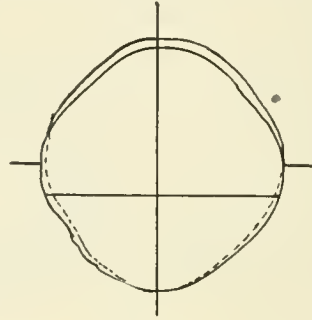

Fig. 39

$= 1\frac{1}{2}^\circ$ out $= 1\frac{1}{2}^\circ$ up, or $+ 1$ axis $45 = 1\frac{1}{2}^\circ$ in $= 1\frac{1}{2}^\circ$ down in the left eye. If this combination were to be fitted in the right eye, it would be $+ 1$ axis $45 = 1\frac{1}{2}^\circ$ in $= 1\frac{1}{2}^\circ$ up, or $+ 1$ axis $45 = 1\frac{1}{2}^\circ$ out $= 1\frac{1}{2}^\circ$ down. By this you will see that it makes considerable difference to which eye the lens is to be fitted. If a lens were ground for the right eye $+ 1$ axis $45 = 1\frac{1}{2}^\circ$ out $= 1\frac{1}{2}^\circ$ up, it could be fitted base in and down, or if to the left eye, it would be in and up, or out and down. These points must be kept in mind when the lens is being ground, also when marking, as it is a very easy matter to cut them wrong. In the combination referred to, $+ 1$ axis $45 = 2^\circ$ axis 45 , the lens would first be lined up on the axis just as though it were a plano cylinder, and in this direction the lines would be continuous; in the opposite direction the line will be broken, as in Fig. 39. A 2° test lens should then be held over the lens to be marked with the apex to base, and when holding the two lenses with the axis at 180° , the lines should be continuous (Fig. 40). If the lenses are held with the axis at 45° , the lines should be cut evenly at the top and bottom (Fig. 36). Either way is correct, but a dot must be placed in the center, otherwise the power of the prism will be changed. When the three dots are in position, that is, the two at the outer edges, and one in the center, the lens is then placed on the axis chart at 45° , and the cutting line drawn.

In a combination with the base of prism at right angles to

the axis, for example, $+ 1$ axis $45 = 2^\circ$ axis 145 , the lens is first lined up across the axis, as at this point the line will be continuous, whereas the line will be cut on the axis. This condition is just the reverse of Fig. 123.

In a combination with the axis of the cylinder, and the base of prism oblique, but at different axes, the marking is quite difficult. For example: $+ 1$ axis $45 = 2^\circ$ axis 25 . In this case we have a double prism, and if a prism chart is at hand, we can locate the combination very easily and treat the lens as such. This com-

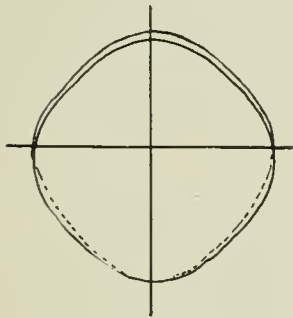

Fig. 40

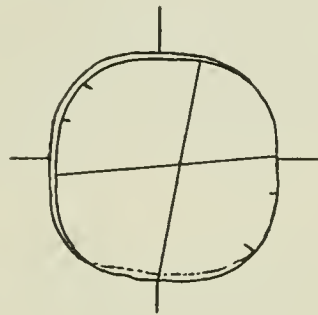

Fig. 41

bination would have the effect of about $1\frac{3}{4}^\circ$ in $= 1^\circ$ up in the right eye, and would appear when held with the axis at 45° , as in Fig. 41. By this you will see that the lines are cut or twisted in both meridians, and of unequal amounts. With the proper test prisms, and placed in the correct position, the lines will be cut evenly. In a complicated lens of this description it is better to mark the axis of the lens, or the cutting line, with a diamond before surface-grinding, and in this way it is only necessary to neutralize the prisms.

CHAPTER V

MARKING PRISMS—(Continued)

Compound prisms are dealt with in much the same manner as cylinder prisms, except that one must bear in mind that there is power in both meridians, and any decentration affects the power of the prism. Any combination with a low power prism will have the center at some point on the lens, so in reality it is really a decentered compound (Fig. 42). It is simply necessary to place this center in some position to produce the necessary prism

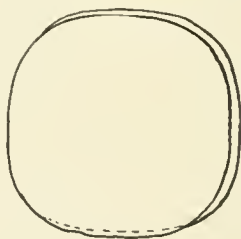

Fig. 42

effect. This is the theory of a compound prism, and the only reason any desired amount of prism cannot be produced is that the lens is not large enough. If one will keep this point in mind, the handling of these lenses is a very simple matter.

The trouble that most opticians have is due to the fact that they seem to have an idea that a prism is some mysterious element. Take for example: $+1 = +1$ axis $90 = 1^\circ$ out. This is one of the simplest forms, and in sighting through a lens of this combination we find that it is centered in the vertical meridian, and that in the horizontal meridian the center is at one side. With a $+2$ spherical we find by referring to the rule, that the center is five millimeters from the line of the axis. As there is a power of 2 D. in this meridian, we would by decentration of 5 mms. obtain a 1° . As this is more than the size of the lens to be cut allows, it is necessary to grind the prism—or in other words, we

grind a lens $+ 1 = + 1$ axis 90, but with the center five millimeters to one side. When we come to mark the lens, if the full amount of prism were not ground, we can decenter it one or two millimeters either way, to produce the full amount. For example: Suppose the lens when coming from the surface department had the center $3\frac{1}{2}$ millimeters from the axis line, we would have then but about $\frac{3}{4}^\circ$ prism; by decentering the lens more we would produce the 1° . If the lens were decentered up or down, we would also produce a prism in this direction, thereby making a double prism. With a cylinder prism, having a combination of $+ 1$ axis $90 = 1^\circ$ out, it would be possible to cut the lens at any point in the vertical meridian without changing the power in any way. This is explained in full in the preceding pages. It will be noted, however, that with a compound prism, it is impossible to do this, and that the lens must be cut at one point on the vertical meridian. If the lens should be ground with a slight prism up or down, it could be decentered to cut this out.

In marking this combination, first line it up at right angles to the axis, place a dot at each edge of the lens, and this will be the cutting line, or mechanical axis. Then select a 1° test lens and hold it over the lens to be marked. We then sight at a straight line and bring the lens in center. At this point place another dot, and this will be the mechanical center; in other words, this point must be placed in the center of the pad on the cutting machine. If a pattern is to be used to cut by hand, place the center of the pattern on this point. After the lens is cut, it will be seen that this is not the true center; this will be at one side. If we are not accurate in placing the lens on the pad or pattern, we can easily lose some of the prism effect.

A sphero cylinder prism, with the axis at 90 or 180° , combined with the prism power, base up or down, is just as simple to mark as a combination with the base in or out. For example, take $+ 1 = + 1$ axis $90 = 1^\circ$ up. This will have the effect of a compound with the combination $+ 1 = + 1$ axis 90 , but the center would be ten millimeters above the middle of the lens. In marking, we would first line up the lens, finding the axis just as though it were a regular compound. In the vertical meridian the line would be continuous; place a dot at each edge of the lens; the center one cannot be marked at this time.

We have now located the axis, and the next step is to make the cutting line, but before this can be done it must be located with a prism. Select the 1° test prism, and place it next the lens to be marked, and line it up at right angles to the axis. When

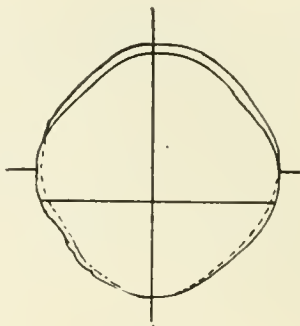

Fig. 43

the lens is in position, so that the line is continuous in this direction, place a dot at this point, in line with the two dots marking the axis. Now place the lens on the axis chart and draw the cutting line. A short cross line should also be drawn in line

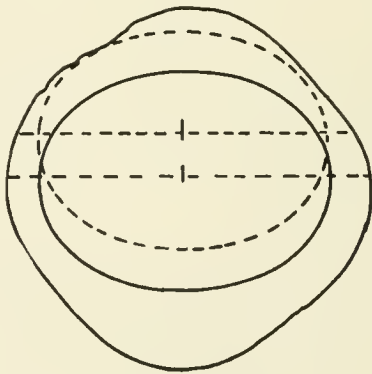

Fig. 44

with the axis dots, to obtain the center in this direction. Fig. 43 shows the position of line in opposite direction to axis before placing prism in position.

A spherocylinder prism with base up or down can be decentered a great many times when it cannot with base in or out, on account of the shape of the lens. It is very rare that a lens is cut wider than thirty-five millimeters, and most of them run

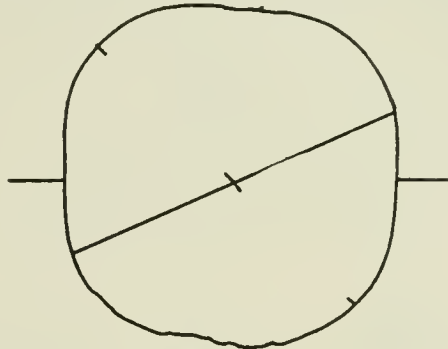

Fig. 45

only from thirty-one to thirty-three millimeters. As the rough lenses are forty-four millimeters from corner to corner, there is quite a little room for decentration (Fig. 44). It should always be remembered that the center of a convex lens with a prism will always be towards the base, and that the center of a concave lens

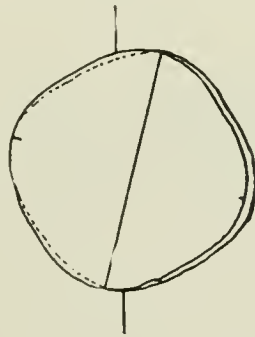

Fig. 46

with a prism will be towards the apex. In this combination just referred to the center will, of course, be up.

With a combination $+ 1 + 1$ axis $45 = 2^\circ$ out, the horizontal line will be cut equally (Fig. 45), but the vertical will be

unequal (Fig. 46). First place a 2° test prism next the lens to be marked to neutralize the prism power, then line up the lens on the axis, just as though it were a regular compound lens. At this time, center the lens in the opposite direction, also, and place a dot at this point. Now lay the lens on the axis chart and draw the cutting line. After marking the lens, it can be verified by sighting at the cross lines; these will appear as in Fig. 46. Now place the test prism in place again and it will be noted that the lines are cut equally in both meridians.

A combination of $+1 = +1$ axis $45 = 2^\circ$ axis 45° will be a double prism, just the same as in a cylinder prism, and should be treated as such. When held at axis 45° the lines will appear

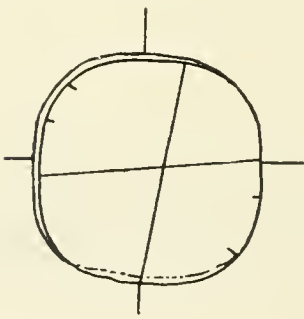

Fig. 47

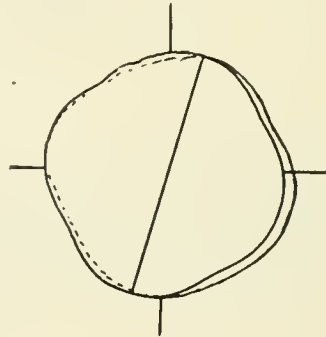

Fig. 48

cut unequally in both meridians (Fig. 47). By turning the lens to 90° , to line it up, it will be noted that it has the effect of a regular sphero cylinder, in this meridian; therefore, the axis is easily lined up. After placing the dots on both edges, take the test prism and place it next the lens to be marked, with the apex exactly in line with the axis. Now sight at the cross-line, and move the lenses until the vertical line is cut equally at top and bottom (Fig. 48). Place a dot at this point and we have the three dots in position to mark the cutting line. Now lay the lens on the axis chart, draw the cutting line, and make a short cross-line for the center. It is absolutely necessary to mark this center, otherwise the power of the prism would be changed if the lens were cut at some other point on the mechanical axis.

A combination $+ 1 = + 1$ axis $45 = 2^\circ$ axis 135 would appear as in Fig. 47, both lines being cut unequally. When turned to axis 90 , as in the previous example, it will not line up, but the lines will be displaced as in a plano prism (Fig. 49). In this case it will be necessary to line up the lens at right angles to

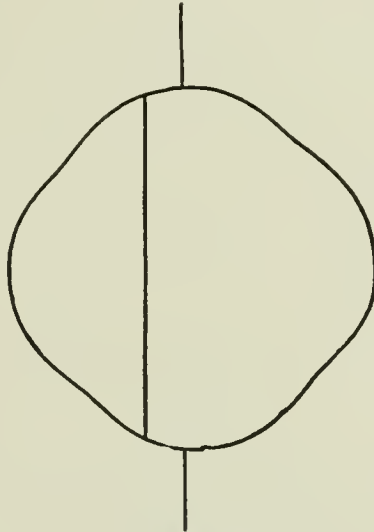

Fig. 49

the axis. In this direction the line will be continuous. Place the dot on the edges in the regular way and then place the test prism in position with the apex at 135° . Now sight at the vertical line and move the lenses until the line is cut equally at top and bottom, and place a dot at this point. The lens is then laid on the axis chart, and marked as before.

With a combination of $+ 1 = + 1$ axis $45 = 2^\circ$ axis 25 the lines will be cut in both directions, and as this is somewhat complicated it is well to mark the axis of the prism with a diamond before surface-grinding. The reason for this is the difficulty to place the test prism in the correct position, and some guesswork is necessary. This combination also has the effect of a double prism.

In grinding all combinations of double prisms, it should be remembered that the correction can be divided between the two

eyes, and still have the same effect. For example: If the prescription calls for R. $+ 1 = + 1$ axis $90 = 1^\circ$ up and 1° out, L. $+ 1 = + 1$ axis $90 = 1^\circ$ down and 1° out, we could grind the lenses R. $+ 1 = + 1$ axis $90 = 2^\circ$ up and L. $+ 1 = + 1$ axis $90 = 2^\circ$ out. This simplifies the grinding to some extent, but the disadvantage is that we do not produce lenses of even thickness. It must be remembered, however, that a prism base out in one eye, and base in in the other has no prismatic effect, as one neutralizes the other. This also applies with prisms base up and down; that is, two lenses placed in a frame, base up, have no prismatic effect, and when dividing the prism power, one must be base up and the other base down. We rarely see mistakes made with prisms in or out, as the prescription reads the same. For example: It is correct to write a prescription $+ 1 = + 1$ axis $90 = 1^\circ$ out OU, and in this case the prism power of 2° is equally divided between the two eyes. If we should write a prescription $+ 1 = + 1$ axis $90 = 1^\circ$ up, OU, it would be wrong, as both prisms would be in the same direction, and would neutralize each other. The correct way to write this prescription is: Right $+ 1 = + 1$ axis $90 = 1^\circ$ up and Left, $+ 1 = 1$ axis $90 = 1^\circ$ down.

Test prisms for neutralizing should always be marked with a diamond on the apex and base, also at right angles on both sides. When the lenses are marked this way we are always sure that they are placed in position correctly.

MARKING KRYPTOKS

Some opticians prefer to purchase their Kryptok lenses uncut, and edge them in their own shop. In marking these lenses, chalk should be used in place of ink, if any marks are to be placed on the disk. For this purpose a glass pencil, such as is used for marking china, is very convenient. It is blue in color, and is very easily distinguished when laid on the axis chart. In marking these lenses, the first step is to make a series of dots around the edge of the disk, so that the outline can be distinguished (Fig. 50). We next line up the distance part of the lens, just as though it were an ordinary lens. If this is a spherical, we need only to find the center and at this point we place a dot or mark a cross, as you prefer. We now lay this on the axis chart, with the

disk in the center, if it is to be in this position, and draw a cutting line.

For lenses of this character, an axis chart as shown in Fig. 51 is a great convenience. For this purpose, take an ordinary paper axis chart, and at a point eleven millimeters below the

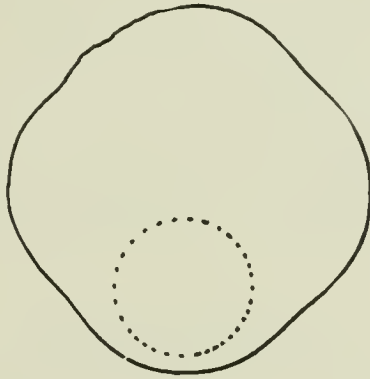

Fig. 50

center, describe a circle eighteen millimeters in diameter. This is the usual size of the disk in this style bifocal. It will be noted that this will bring the top of the circle two millimeters below the center of the chart. This is the usual position of the disk on all lenses, and unless otherwise ordered, a disk or wafer, if a cement bifocal, should be placed two millimeters below the center of the distance lens. It is always well to consider this point, however, for if the glasses are to be worn constantly and the patient desires to read very little, a small disk can be used. On the other hand, if they are to be used constantly for near work and the patient desires only to glance up occasionally, a larger disk is more desirable. In a case of this kind, the disk is brought up to the center of the distance lens, and sometimes above. As eighteen millimeters is the average size, and two millimeters below center the usual position, it is best to make the chart this way, and make the necessary allowances for the occasional conditions. This circle will be used for cases where the disk is to be in the center, and for jobs where the disk is to be set in one or two millimeters it is necessary to have another circle.

For this one, select a point two millimeters at one side, and in the same line as the first one, and describe another circle of the same size. At a point the same distance on the opposite side, describe another circle. This makes three circles, one in the center, and one at each side. For a Right lens, we will use the circle at the left, and for a left lens, the one at the right. These are drawn, however, for two millimeters displacement, and when it is desired to set the disk in but one millimeter, the disk can be placed half-way between the two.

In marking a spherical lens it is only necessary to place the center of the distance lens on the center of the chart, and twist the lens until the disk coincides with the circle in whatever position you desire to place it. A cutting line or mechanical axis is then drawn, and the lens is ready to cut. In cylinders or com-

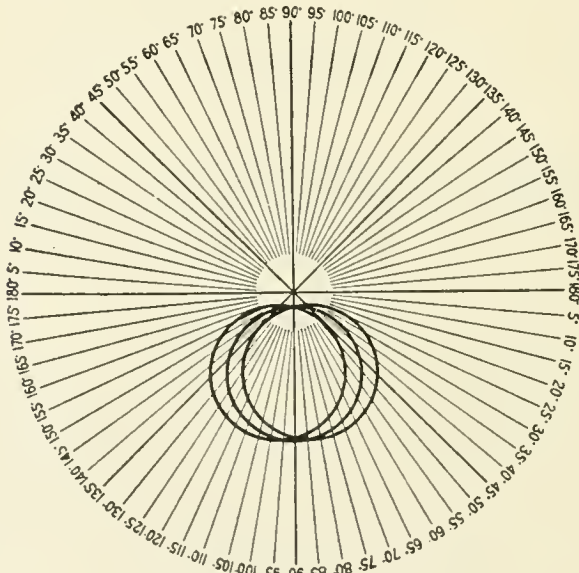

Fig. 51

pounds, the disk is dotted as before described. The distance lens is then lined up for the axis. This is dotted in the usual way, but always select the meridian that does not pass through the disk, if possible. For example: If the lens is to be axis 90° , it is

better to line it up on the 180° line first, as we can then sight away across the lens. If we line it up at 90° the disk interferes.

When the axis has been located and dotted, lay the lens on the axis chart, with the dots at the proper axis, and the disk over the circle which is in the correct position. It will be noted that this lens cannot be twisted the same as a spherical. In twisting a lens of this kind, either the axis or the disk will be thrown out of position. We can, however, move the lens to one side in order to bring the disk in the correct position, without changing the axis. In laying the lens on the chart, notice at all points if the lens is correct. First the axis, then the location of disk, in or out, and also if top of disk is the correct distance below the center of the distance lens. If all points are correct, draw the cutting line, or mechanical axis. If for any reason the axis is not correct, the cylinder can be reground and corrected, provided the lens is not too thin. Also notice that the disks on the two lenses match; that is, do not get one on center, and one set in; also one higher than the other, as this will make the disks appear different in shape and size (Fig. 52). Be particular also when the wafers are to be set in that you do not make a mistake, and mark both lenses for one eye. If this should happen, you will see after cutting that one disk will be in and the other out. This will necessitate the grinding of another lens. As the disks on these lenses are smaller than the regular cement size, and also as the eyes converge looking at a near point, according to theory, they should always be set in at least one millimeter.

MARKING CROSS CYLINDERS

Cross cylinders, with the axes at right angles, are just as simple to mark as compounds, but with the axes at any other angles, it is very difficult to find the correct axis. In preparing lenses of this character to be surface-ground, they should always be scratched with a diamond. A peculiar feature about these lenses prevents their being lined up the same as any other lens. This is the fact that they always line up at right angles, no matter where the axes are. For example: $+1$ axis $25 = -1$ axis 90 would have the axes according to the prescription 65° apart, and yet in reality they would line up at 90° apart just the

same as any compound. The true position of the lines would be at axes 12° and 102° (Fig. 53). If we could transpose a combination of this kind mathematically in a few seconds we would know just where to line it up. As this is impossible, and in fact

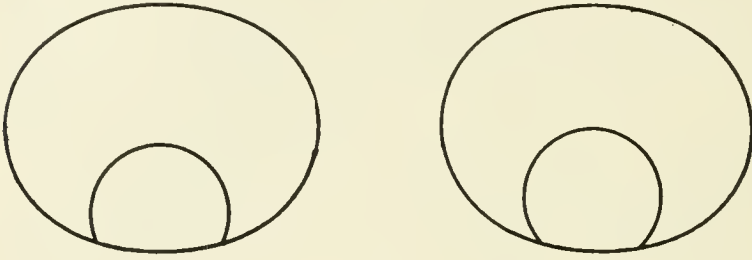

Fig. 52

only a very few can work them out any way, it is much better for us to depend on our axis marks. The simplest method of transposing cross cylinders is to take two cylinders, and after marking the axis of each, place them together, and then line up the combination. If one finds it difficult to hold them without

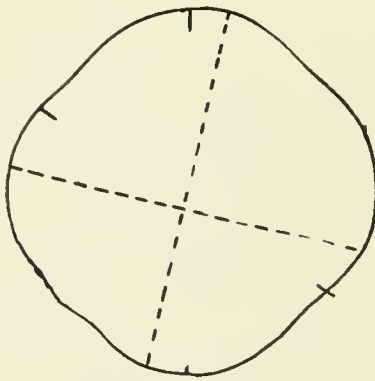

Fig. 53

slipping, the two plane surfaces can be cemented together. If for any reason a cylinder is surface-ground, and the diamond marks were omitted, the simplest way to locate the axis is with the lens measure. First locate it as near as possible, and then place dots on both edges. Then take the lens measure again and place the

points in line with the axis, and by twisting it a few degrees either way, and noticing the movement of the pointer, the axis can be found within one degree. There is a new instrument on the market, known as the Axis Indicator, which is used in conjunction with the lens measure, and is invaluable for this work.

BIFOCALS

In selecting stock for bifocals the upper lenses are marked as usual with one exception, and that is, the wafers are always placed on the inside when possible. For sphericals, periscopic lenses are used for the uppers and "regular" wafers are cemented on the inside. For example: Prescription distance + 2; reading + 4, select + 2 Pcx. and a "regular" wafer, having a + 2 power, which is the necessary addition for reading. This will be + 1.25 on one side and + .75 on the other. The + 1.25 side is cemented to the - 1.25 curve on the upper lens. The + .75 on the outside of the wafer and the + 3.25 on the outside of the upper lens will then give us the required focus (Fig. 54). The

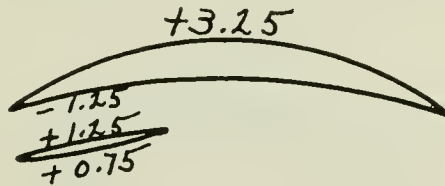

Fig. 54

contact surfaces are not considered in any way, other than that they must fit perfectly as they have nothing whatever to do with the focus of the lens when the index of the glass is the same. If it is different, as in fused bifocals, it is then an important matter, and must be taken into consideration.

For cylinders plano wafers are used and cemented on the plano side. You will have no trouble with these, as the power of the wafer is all on one side. Be careful, however, never to cement a wafer on a cylinder surface, as the cylinder effect is then destroyed. Compounds are a little more difficult, but are simple when understood. The wafer is usually placed on the inside in weak combinations. The only reason for this is to make them more invisible. Whichever way they are made the wafer will have

to be cemented to the spherical surface, and here is where you will, perhaps, be confused in marking. Be sure that you lay the lens on the protractor, with the surface upward, that is, to be next the eye. If the spherical is to be *in*, mark it on the spherical side. If the cylinder is *in*, mark on the cylinder side. You can readily see that if the axis is to be 45, with the cylinder surface out, and you mark it on the cylinder side, and then turn it over, the axis will be 135°. In selecting the wafers the contact surface will be the same power as the spherical surface on the compound, but the curve will be the reverse. To this power add the amount to be added for reading and you will have the outside surface. For example: Prescription $+ 1 \text{ C} + .50$, axis 90°, distance add $+ 2$ for reading. We will first select $- 1$ to fit the $+ 1$ surface, and by adding the $+ 2$ for reading we have $+ 3$. Then the wafer wanted is $- 1 \text{ C} + 3$.

CUTTING

You should first become familiar with the working of your machine. Read the directions and be sure that you understand how to set it for size. Some of them are set by charts. That is,

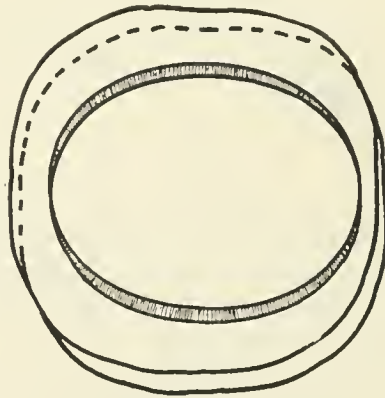

Fig. 55

for length and width. Others are set by the difference between the length and width. In other words, the patterns are marked from 4 to 12, so that 40 x 33 would require No. 7 pattern, and the gage is set at the length, 40 mm. In cutting for frameless, allow 1 mm. on the length and width. For above size it should be cut

41 x 34. For frame size, it is best to cut a lens and try it in the frame, allowing about $\frac{1}{8}$ to $\frac{3}{16}$ inches between the end piece, according to the thickness. After you have ground one or two, you can judge for yourself just the amount you will need for grinding.

When the machine is in position to cut the handle on the top gear should be at the right. It should always be turned to the left,

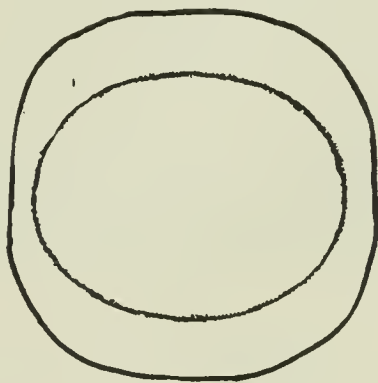

Fig. 56

making one revolution, and stopping at just the point where it started to cut. *Never, under any circumstances, run by this point, as you will spoil the diamond.* If, for any reason, you do not get a satisfactory cut it is better to turn it over and try again on the other side. In placing the lens on the pad see that it fits perfectly flat and does not rock. If you have a universal pad it will be all right; but if your machine has a number of pads select the one nearest the curve of the lens. Also cut on the surface having the least power on the nearest to plano. In laying the lens on the pad, the cutting line should be on the 180° line on the cutter, with the center on or under the centering pin, whichever way the machine is constructed. When the lens is in position, raise it to the diamond by pressing the hand lever on the left side. Start gently at first, increasing the pressure gradually, turning the lens slowly at the same time. Some diamonds require more pressure than others, but you must experiment carefully until you find that you get a perfect cut (Fig. 55). This you will see has a sharp line which runs almost through the lens. If you put too

much pressure on it you will have a scratch (Fig. 56). This lens you will find very difficult to break down, and probably break over the mark, unless you are extremely careful.

There is another way to cut a lens without marking and in this way you turn the pad in the machine so that the line corresponds to whatever axis you are to cut on the graduated scale. The lens is then placed with the axis dots on the line on the pad. This will give you the same result, and, although it saves time, it is not so accurate. Strong lenses and high curve torics can be cut better by hand. These are marked in the same way, selecting a brass pattern the exact size of the frame or the dimensions of the frameless lens to be ground. Lay this on the lens with the three holes over the dots, or on the cutting line, holding it in the left hand with your thumb on the pattern. Use the diamond in the right hand in a vertical position, the same as a pencil, or with the handle between the index and third fingers. Cut lightly around the pattern and be careful not to run over the line.

CHAPTER VI

CUTTING COMPLICATED LENSES

Complicated or expensive lenses should be cut by hand in some cases, and although many are cut by machine, one should be sure that every part is in perfect working order. One of the most essential things is to see that the pad on which the lens is laid fits the under surface of the lens perfectly. It does not

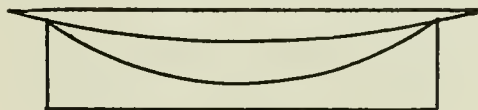

Fig. 57

matter so much about the center, unless the lens is very thin; in this case care will have to be used to prevent the center pin, which keeps the lens from slipping, from punching through the center.

In selecting a pad to fit a lens, notice if it has a good bearing under the part where the diamond travels. If the lens has a deep

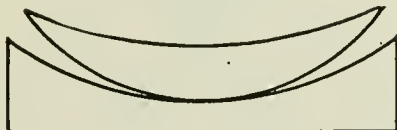

Fig. 58

curve, and the pad is shallow, the point of contact will be in the center, and there will be no bearing under the diamond. In a case of this kind, the lens has a tendency to rock; this is not only liable to cause the lens to slip, but even if the diamond cuts at all, the best results will not be obtained. Fig. 57 shows a lens on a pad too deep; Fig. 58, one too shallow; Fig. 59, the correct curvature. These illustrate toric lenses, or lenses with strong outside curves.

Flat lenses should always be placed on a flat pad. Many opticians neglect to change their pads, however, and although a

flat lens could be cut on a pad having a slightly concaved surface, it would be impossible to get good results on a pad having a convex surface, as the lens would have a tendency to tilt (Fig. 60).

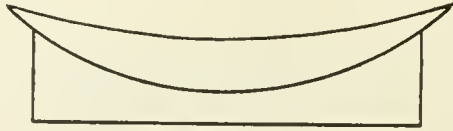

Fig. 59

A very good pad is now furnished with some machines, that might rightly be termed "A Universal Pad." This consists of a flat rubber pad having a raised oval-shaped center (Fig. 61). A

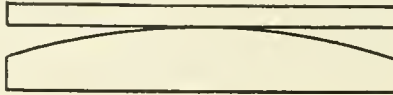

Fig. 60

flat lens when lying on this pad will rest on the top, and as the oval is about the average size of lenses cut, it has a very good bearing. A concave lens rests on the inside of the oval, and as

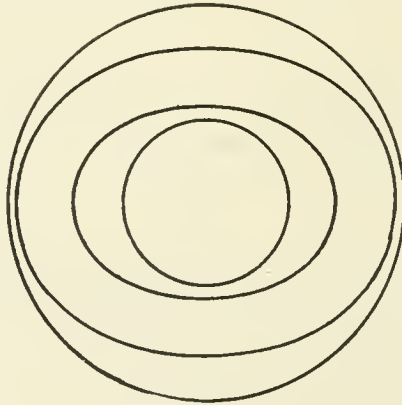

Fig. 61

the center of the pad is cupped out, it does not touch at this point. A concave lens rests on the outside of the oval, and as the pad is flat outside of the raised part, it allows room for the thick

edges to overhang (Fig. 62). This pad can also be used for toric lenses of ordinary curve.

Having made sure that the lenses rest properly on the pads, then notice if the foot that presses in the center is adjusted correctly. Some machines have a screw adjustment which allows

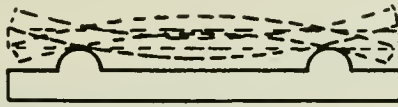

Fig. 62

it to be regulated to the proper tension, and others work entirely by spring tension. The points of contact also vary, some are just a rounded metal surface, and some have a ring about $\frac{3}{4}$ " diameter, and still another has three rubber-covered points in the shape of a tripod. Whatever style is used, be sure that they are adjusted to prevent the lens from changing its position, thereby throwing the axis out; or else obtaining an irregular shape. Next be sure the diamond is cutting in good shape; do not attempt to



Fig. 63

use one that needs resetting, as a poor diamond can easily spoil a pair of lenses that would cost more than the cost of resetting.

That the formation of a cutting stone may be thoroughly understood, we show an enlarged illustration of a point (Fig. 63). This is of natural formation, and cannot be recut. It can be reset at a different angle, or if this point has been damaged, a new one on the same stone can be used. The best machines are supplied with Brazilian sparks, and although African sparks look the same to a novice, they will not produce as good results. This point should always be considered when purchasing a machine. This also applies to hand diamonds. Many opticians have a mistaken idea regarding these tools. There are offered for sale

glazer's diamonds at a low figure, and many times they are purchased at pawnshops or second-hand stores as low as one dollar. A good hand diamond for optical use costs at least five dollars, and is well worth the investment (Fig. 64).

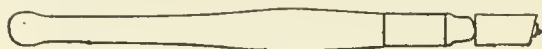

Fig. 64

A diamond that has lost its cutting point will only scratch. As soon as this is noticed, experiment a little and see if a cut cannot be obtained by using a different pressure. The amount of pressure required varies, but this does not necessarily mean that the best diamonds require light pressure. In fact, one that requires a fairly firm pressure is to be desired, as a cut may then be forced away through the glass. As previously stated, as soon

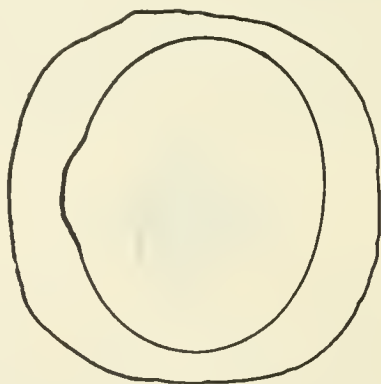

Fig. 65

as it is noticed that the diamond is not cutting properly, have it attended to at once.

There is another point regarding the setting of a diamond, and that is the angle. A diamond may cut properly in a straight line, but when used on curves it will not cut at all. We occasionally find this trouble with cutting machines, and frequently the lens may be cut all right all the way around, except at one point on the side (Fig. 65). At this point the diamond has a tendency to travel away from the pattern, thereby causing a

hump on the side. This may be prevented in some cases by increasing the spring tension, but if it requires more than a reasonable amount, or if it does not remedy the difficulty, the diamond should be reset.

There may be another cause for this, and that is the micrometer head may not swing easily in the arm that holds it. In most

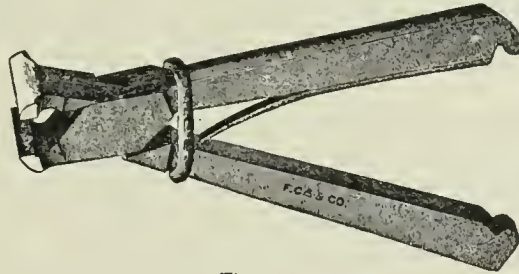

Fig. 66

machines there is a set screw with a check-nut at the top to regulate the play at this point. This should be adjusted so there is no play up and down, but so the micrometer head swings easily. A drop of oil at this point will also help a little. If this is adjusted so that it works too stiff, the micrometer head has a tendency to travel in a straight line, rather than to follow the curve of the pattern.

This theory also applies to a hand diamond, and we find in use a great many so-called pencil diamonds. These are simply straight handles with a diamond set in the end. They may possibly have one cutting point, but as a rule are intended for scratching, marking or writing on glass. A good hand diamond has a swivel in which the diamond is set, and in this way the point follows the curve of the pattern. The best glazier's diamonds are also made in this way, but the swivel is very large, and is intended to be used with a thick straight edge. An optician uses a diamond around a thin brass pattern, consequently these will not answer. The regular optician's diamond is set so that one side of the stone bears directly against the pattern, and in this way a close cut is obtained. Rather than use a poor diamond, one can just as well use a steel point. One of these can be made very easily out of a rat-tail file, and by grinding a short stubby

point it will scratch as well as a diamond. Many use these for cutting (although really scratching) wafers. If one desires good cutting, it can only be obtained with the best diamonds.

After a diamond has been reset, it will be necessary to change the size adjustment. Some machines are so arranged that this can easily be done, and others require special scales; in either case, cut a lens and measure it with a rule. Then work from this as a basis, and if you are obliged to make out a chart, do so; but if the machine can be adjusted, it is much more satisfactory.

For breaking down lenses after they are cut, breaking tongs, similar to Fig. 66, are to be preferred. Many use flat nose, or cutting pliers. There are also tongs with straight jaws, but those with the side jaw are easiest to handle. These jaws on the inside are rough, so that they grip the glass in good shape; other pliers, such as cutting pliers, snap the glass rather than break it easily.

In breaking down lenses, hold the lens in the left hand, using the side of the breaking tongs, and start on the end of the lens. Do not use the top, as this is somewhat awkward. After breaking it down as well as possible, cribbers should be used (Fig. 67). These consist of a pair of scissors, so to speak, having

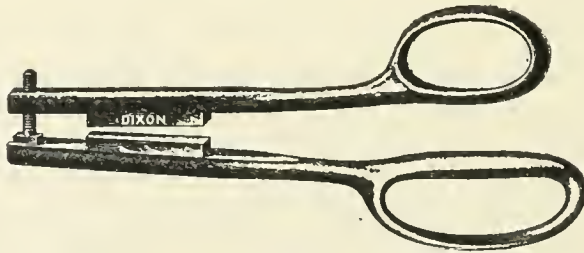

Fig. 67

square iron pieces on the inside of the jaws. The glass will roughen the iron, and gradually wear it away, and at the same time it makes a natural shape which seems to take hold of the glass better. A workman using these all the time will wear them down to a point where they can hardly be used, rather than fit new pieces to the jaws in order to preserve the curve in the jaws. After the jaws have been worn considerably, they can be turned

over, and the opposite side used. These pieces are soft-soldered to the jaws, and need only to be heated slightly, and will then drop off. The end, it will be noticed, is fitted with a screw; this is to allow for different thicknesses of lenses.

Strong concave lenses, thick prisms and deep torics can best be cut by hand, and for this purpose the thin brass patterns are used. These can be curved to fit the surface to be cut. If one does not have an automatic machine, the lenses must be cut and

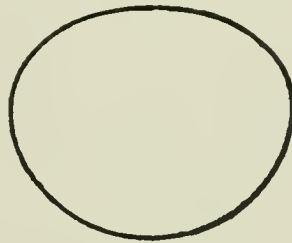

Fig. 68

shaped better. With an automatic grinder many of these thick lenses can be cut large, and the machine can be set to grind to size. This method is used by some opticians for frame work. The bevel is then put on afterward by hand.

Automobile goggles require a great many shapes, and if one does not have an assortment of metal patterns, a temporary one can be cut out of cardboard. Many of these lenses are made from window glass, or in other words, it is blown instead of moulded. Glasses for stone-cutter's spectacles are also made from this quality of glass, and if one has much of this class of work to do, it is better to have a special diamond for the purpose, especially for machine work. This point should also be kept in mind when ordering a diamond reset, for it is possible to reset a diamond that will cut perfectly on one kind of glass, and give very satisfactory results on another. This also applies to B. & L. and A. O. Co. glass. If a diamond is set for B. & L. it may not produce good results on A. O. Co., although we have always found that one set for A. O. Co. will cut B. & L. If your diamond is to be reset by any other than an optical workman, it is a good idea to furnish them with samples of both kinds of glass, otherwise they will probably use window glass to experi-

ment on, and the best results will not be obtained on optical glass. No matter what method or what machine you use, it is well to watch an expert, if possible, or at least see samples of what can be done by others. In this way you can readily see if you are getting all that you can out of your machine. If you do not, there is trouble somewhere, either with you or with the machine.

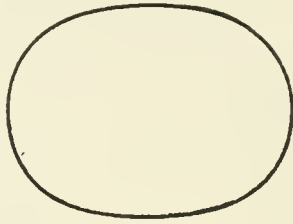

Fig. 69

There are many odd-shaped lenses in use at the present time, but the majority can be cut by machine. Many opticians do not understand that drop eyes (Fig. 68) can be made with any difference between the length and width. Although No. 9 is the regular shape for an oval lens, in the drop eye it looks somewhat pointed. No. 7 shape (Fig. 70) is to be preferred to No. 9, and if one desires still more drop, No. 5 makes a good shape. These patterns are carried in stock by the factories, with

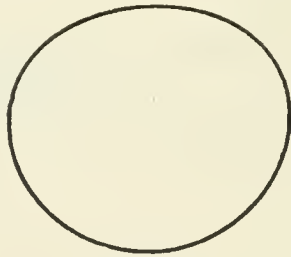

Fig. 70

proportions ranging from 4 to 10, and if it is possible to use them on your machine, it will save considerable work, as well as time, to have them.

Clerical eyes cannot be cut by machine on account of the flat top, and also because usually the width is very narrow. The

most common sizes are 40 x 20 and 38 x 18. These are also made with a crescent-shaped top. All these styles have to be cut by hand.

There are also many lenses in use that have what is commonly called "full ends" (Fig. 69). These run slightly more toward a square shape than the regular ovals. Patterns for your machine can also be obtained for this class of work, although if your machine has a fixed pattern that cannot be changed, these can be cut by hand. A great many opticians are running on special shapes of this kind, on account of the advertising feature, as well as the desire to be exclusive. In a small city or town having four or five opticians, competition is very apt to be keen. If one of these grinds a special shape it may be possible that his competitors may not have grinding plants, and in this case they are unable to use a stock lens, but will be obliged to send it away. As this will take at least twenty-four hours, the customer may object to waiting that length of time. The original maker could, however, duplicate the lens while the customer waited, if necessary, and in this way it forces the customers to bring their repairs to him. If you desire to have a shape of your own, it is well to have a special pattern made for this purpose.

CHAPTER VII

LENS GRINDING

For hand grinding a large stone is preferable, and the size most commonly used is 24 inches diameter by $1\frac{1}{2}$ inches face. Craigleith, corundum or carborundum can be used, but the corundum, called by the trade name Alundum, is the best. This size should run at about 225 revolutions, or 1415 feet per minute. To obtain the proper speed for any size stone, multiply the diameter by $3\frac{1}{7}$, and then multiply by the number of revolutions desired.

The stone should turn away from the grinder and should be kept wet by a drip or sponge on the back. It is unnecessary to have a great amount of water on the stone, so that it will fly all over everything, but keep it just wet enough so that it will not run dry. With ordinary care the stone will keep in shape, but if it becomes rough it should be smoothed with a piece of the same material. Do not use a piece of craigleith on an alundum, or *vice versa*.

The turning can be done by hand, but not as well. When turning without a truing device the diamond is held in the right hand and the left is used to steady and guide it. A board is placed on the trough at the back, so that it just clears the stone; this is used as a rest. The diamond tool is then started at either edge and rolled along, so to speak, on the rest, so that the stone is cut evenly. Enough should be taken off so that the surface is square and true. A carborundum block should then be used on the back to smooth it, or, in other words, take out the ridges left by the diamond. The stone should then be honed with a piece of the same material, held in the hands, on the front.

When the lenses are cut and ready to be ground, they should be rinsed in water to remove all the glass dust, otherwise this gets into the fingers, and as the lens is revolved, it scratches the surface. In large shops there is apt to be quite a little waste from scratching, and this is usually the cause. A rubber coin pad, such as are often seen on counters, and which can be obtained in any

rubber store, is convenient to lay lenses on, and prevents scratching.

If the lenses are well shaped with the cribbers, there is very little difficulty in putting on the level, but if there are bunches and points to be ground off, this is where skill is required. The shaping is the first important point, and the eye should be trained to judge ovals. The axis should also be watched at the same time

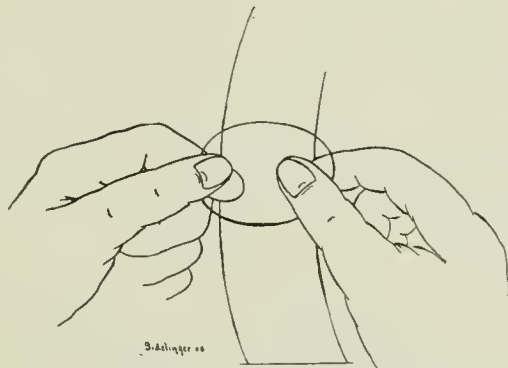

Fig. 71

and see that you do not grind it off. If the lens is cut large, and this very often happens, it is a good plan to mark it occasionally.

In shaping the lens, it should be held between the thumb and forefinger of both hands (Fig. 71) at a slight angle, turning it from left to right. The points and bunches should be taken off until you have a good oval. The lens should then be held between the thumb of the right hand and the forefinger of the left (Fig. 72). It should then be revolved with the forefinger of the right hand as far as possible and then picked up with the thumb of the left until you can get another hold with the forefinger of the right hand. In this way the lens can be revolved as steadily as if it were in a machine. If you have trouble with the lens sticking to your fingers, a little piece of soap can be kept handy, and by just touching it occasionally you will avoid this annoyance.

The lens should be beveled a little first on one side, then turned over and ground the same amount on the other. Too much pressure should not be used, as it is better not to try to grind too fast. As soon as the lens is beveled on both sides, it should be tried in the frame for size. The screw should be taken out and

the temple removed, and to bring the joints together, an old pair of cutting pliers having the edges drilled should be used.

As the lens is tried in the frame, you should learn to judge the amount it will be necessary to grind off. In any case, however, the lens should be tried frequently, so that it will not be ground too small. It should be fitted so that the joints just come together, and no light can be seen between them with the lens



Fig. 72

perfectly tight, and as the joints are held with the pliers in the right hand, try to twist the lens with the left. The level should be perfectly smooth, and equal on both sides, with no chips or bright places; if it does not come out this way the lens was cut too small. Just before trying the last time, the lens should be held in the right hand between the thumb and forefinger in a vertical position, and allowed to turn on the stone a couple of times to take off the sharp edge, otherwise it will chip when the joints are screwed up.

When the lens is placed in the frame see that the strongest concave, or weakest convex surface, is next the eye, so that the axis will be right (the lens should have been cut this way). Also

see that the ends of the lens come to the center of the joints and foot of the bridge. Never mind if the frame is out of shape, put the lens in right and true the frame so that the lenses will be horizontal afterward. In grinding the lens for the other eye care should be used to keep the shape the same.

When grinding torics, coquilles and strong lenses, the frame should be curved slightly to conform with the shape of the lens, otherwise the eye wire will spring off the bevel, causing the lens to drop out. Clerical, or half eyes, are difficult to grind and care should be used to fit the corners well before attempting to reduce the lens to size. After the corners and top are fitted the surplus glass can be ground off the lower part.

Pebbles cannot be ground successfully on an ordinary alundum stone, as special grit is required. Carborundum is the best, but craigleith answers the purpose very well, although it is slow cutting.

Window glass should not be ground on your stone, as this has a tendency to rough it.

Strong lenses require a steeper bevel than the regular, and as the high power convex are thin on the ends and thick on the sides, it is well to start the bevel on the sides first and grind the ends last, otherwise the lens will be too full.

In fitting lenses to rubber or zylonite frames, the frames should be softened in hot water or over a gas flame. Extreme care must be used not to burn the frame. Shell should never be attempted, as these are very brittle and are costly to repair. When fitting lenses to metal lorgnettes, it is advisable to cover the handle with tissue paper or cloth to prevent scratching. We advise, however, that these difficult jobs be sent to the prescription houses, as it is often expensive to repair or replace these frames should they become damaged or broken.

For hand grinding the lens is cut $\frac{1}{2}$ mm. larger all around, and the first operation is to shape it. It is held in the center between the thumb and forefinger of the right hand in a vertical position. The left thumb and forefinger are used as a rest and guide (Fig. 73). The points and bunches are then ground off until you have a true oval. The lens is then held in the same position, but allowed to revolve slowly. This is done by pressing gently against the stone and allowing the lens to slip between the fingers in the right hand; the left is simply to steady and guide it.

Care should be taken not to let it get away from you, but with a little practice it can be revolved as steadily as a machine.

After the lens is down to size and the edge is flat and smooth, the sharp edge should be taken off, or, in other words, put on a very small bevel. Strong lenses and torics will require more



Fig. 73

bevel where the straps are fitted to prevent chipping. In this operation the lens is held in the same position as in grinding lenses for frame (Fig. 72). If a new pair of lenses is being ground they should be measured in millimeters for length and width. The sizes are as follows: 1 eye, 37 x 28; 0 eye, 38½ x 29½; 00 eye, 40 x 31; 000 eye, 41 x 32; 0000 eye, 44 x 30. Full eyes or short ovals are the same length, but two (2) mm. wider.

For measuring, a millimeter rule is considered accurate enough, but if you wish to be exact, a Boley gage is better. In matching a broken lens, you can lay the new one over the old one and judge the size, but this requires practice. The shape should also be noted as it is possible to grind two lenses having the same length and width, but the shape will be different, one may have

full corners (Fig. 74) and the other pointed (Fig. 75). Some prefer the shape with full corners, as it gives a straighter surface for the strap to bear against, and, consequently, does not loosen as easily.

Drop eye lenses (designated by various trade names in different parts of the country) are ground in the same manner. These

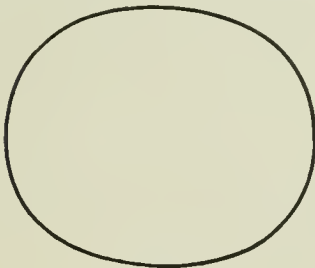

Fig. 74

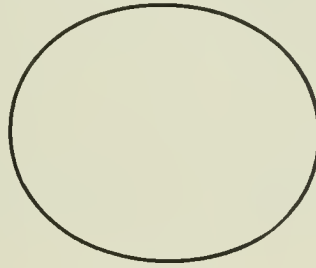

Fig. 75

are ground off axis very easily, so this point should be looked out for. Also see that the ends are not ground too quickly, as the shape will lose its identity and the results will be more like a regular oval.

DIFFERENT METHODS OF GRINDING

We have already described the correct methods of grinding, but as there are other methods in common use, we will add a few suggestions. By correct methods is meant those that are most generally used by expert workmen, and are usually adopted by the most successful. There are many grinders that prefer their own method, and some of these may come easier to certain individuals.

The first method adopted by the beginner for hand-grinding is that described and illustrated on page 64 (Fig. 73). While this is supposed to be used only in shaping the lens, many opticians continue to grind the entire bevel in this manner. A very fair job can be obtained by this method, but the edge will always show little points or humps where the position was changed in order to obtain a new hold on the lens. For factory work, and also prescription work, as it is turned out by the best prescription houses, this would hardly answer, as the bevel must be continuous and regular in order to pass inspection.

The correct and most common method is shown in Fig. 74, page 65, but another that is equally as good is one where the lens is held in the right hand between the thumb and forefinger. This position as far as holding the lens, is the same as in Fig. 75 (which is the correct position for rimless grinding), illustrated on page 65 of this chapter. Instead of holding it in a vertical position as in grinding rimless lenses, it is held on the stone at an angle of 135° . If the lens were held in a vertical position, and then tipped to one side in order to obtain the correct angle for the bevel, the forefinger would naturally touch the stone. By turning the lens at an angle of 135° , a convenient position is found, and at the same time the correct angle for the bevel is obtained. By a little experimenting, one can find an angle to suit. When this angle has been located, allow the lens to bear on the stone, and it will be noted that as the stone revolves, it will have

**Fig. 76**

a tendency to carry the lens with it. By pinching the lens a little with the thumb and forefinger of the right hand, and guiding it with the thumb and forefinger of the left hand, the speed can be regulated at will. With this method the lens should be cut fairly close, and also have a perfect shape. If the lens is not symmetrical it must first be shaped up, using the method before described and illustrated by Fig. 73, page 64. As one becomes

more expert in grinding one will see that it is very essential to have the lenses well cut, and cribbed into shape.

In the last method described, one really handles the lens just as though it were in a machine, and no pattern was used. In this way the lens follows the original shape, and in grinding we only put on a bevel.

The correct method of rimless grinding by hand is shown in Fig. 75, page 65. The beginner usually finds it most con-

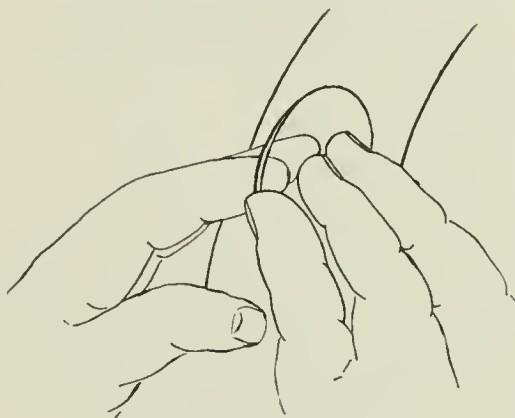

Fig. 77

venient to stand a little to the left of the stone and hold the lens in the right hand between the thumb and fore and middle fingers (Fig. 76). In this method the lens is ground at a point on the stone, very near the top. The movement is a long, sweeping motion, using the entire arm from the shoulder. First start with the lens held so that it touches near the lower end, then move it downward in the opposite direction to that in which the stone is turning, and roll it, so to speak, as far as possible. This should carry the lens to the other end, thereby having ground one side. A new hold is taken to turn around the end, then a new start for the other side. In this way it requires about four turns to complete one revolution. If there is any shaping to be done it must be looked after at this time, and after each sweep of the lens it should be inspected for shape. As one becomes experienced, this will require only a second or two, and really the grinding can almost be watched on the stone.

After the lens is ground to the approximate size by this method, the shape having been found to be correct, the edge will probably be more or less uneven. By this is meant that there will be a number of ridges at different points where a new start was made when changing the position of the lens in the hand. These should be taken out, and the lens given a finish that will appear as near like a machine-ground lens as we can. This is possible by holding the lens in such a position that will allow the stone to cause it to revolve between the fingers. The correct way is the same as illustrated in Fig. 75, page 65, but some of the older grinders prefer a method as illustrated in Fig. 77. In this method the lens is held by the two fingers of both hands in such a manner that they act the same as the two shafts in an automatic machine. The thumb of one hand, or both if preferred, is placed on the edge to act as a stop or governor. A certain amount of pressure must be used on the surface of the glass to keep the glass from slipping, and if the thumb is not used to govern it, it will revolve too rapidly. The revolution must be as regular as possible in order that the shape may be preserved as well as producing a perfectly flat edge. As the lens is ground in this manner the size should be kept in mind, so that it will not be ground too small. When the lens is just to size the sharp edges should be run off as usual, and as heretofore described.

GRINDING FRAMELESS LENSES BY MACHINE

After the lenses are in position start the machine and let the lenses down to the stone.

For machine the lens should be cut a little larger than for hand grinding, usually about 1 mm. all around is allowed. The marked places on the lenses for cutting are used to center the lenses in the machine. The lenses are placed in the centering device with the cutting lines, together with a piece of rubber or wet cardboard between them to keep them from slipping. Extreme care must be used to see that these are placed on the pads just right so that the axes and centers will be perfect. A little slip at this point will spoil your lenses.

The two principal styles of centering devices now used are somewhat similar in the method of using, but radically different in construction. One such device is constructed on the clamp

idea, and is forced open by a spiral spring. The machines fitted with this device are supplied with a thick pad resembling a pattern or former (Fig. 78), slotted on the back to engage the pins on the head spindle of the machine. The top is oval in shape, fitted with a rubber pad in the center and at each end is a hole to engage the pins of the centering device.

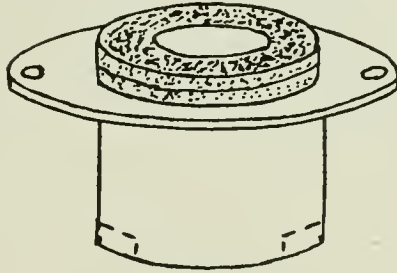

Fig. 78

If the lenses have been properly marked before cutting there will be no difficulty in placing them on the pad to obtain the correct axis and center. If not, it will be noted at this point how essential it is to have a conspicuous line on the lens. The centering device is held in the right hand, and the lens in the left. If two or more are to be inserted rubber washers or wet cardboard pads should be placed between them. It will also be found more convenient to place them together, or build them up in the hands first, and then place them on the pad at one time. When placing them on the pad, see that the line passes directly over the holes in the pad, and that the center comes directly in the center of the hole in the middle of the pad also. The centering device is then pressed together with the thumb of the right hand and held in position with the left hand while the set screw is tightened. The lenses should then be held securely, and it will be possible to inspect them, and see if they have been placed in position correctly. On the top of the prongs of the centering device will be found two holes, through which the line on the lens can be distinguished, and by sighting through these the line should be seen directly in the center. A little study on the part of the operator will readily convince him that if the lens has been placed on the pad accurately it cannot possibly grind off axis or center, pro-

vided that they do not slip in the machine. If the lens has been placed in position carelessly it cannot grind correctly and, therefore, do not blame the machine for any inaccuracy. The pattern can be selected and placed on the head spindle, as previously described, and the gauge set for the size, which is governed by the length of lens to be ground.

For size subtract the width from the length and the difference will indicate the number of the pattern to be used. This is placed in the machine and the gage set to the length required. For example, to grind 40×31 , the difference is 9. Fit this pattern and set the pointer to 40 mm.

When the lens has been secured in the centering device, it is ready to place in the machine. Open the tail spindle with the hand-wheel so that there will be plenty of room to place the lens in position. Be particular regarding this point, for if for any reason the lens should strike any part of the machine when being inserted, it will be very liable to slip, thereby throwing it off axis, or out of center. Place the holes in the pad over the pins on which the pattern or former has been placed, and when set correctly, turn the hand-wheel up until the right hand pad strikes the surface of the lens. At this point the hand-wheel will turn very easily, or in other words, loosely, so that it will appear to slip. It can then be given a turn or two more, very lightly, until the hand-wheel just touches the spring on the end of the tail spindle. Do not, under any circumstances, turn it up hard, for it will not only do no good, but it may damage the machine, by forcing the spring out of place. When the hand-wheel has been turned up in this manner the lens is secured just as firmly as it can be, and if for any reason it should slip, it will be because the rubber pads do not hold it properly. Either the rubber has lost its elasticity, or else they may have become covered with grease. In this case clean and dry them, or fit new ones. In fitting new pads, secure them with sealing wax, as this is the best method.

The lens should then be let down to the stone gently and allowed to grind around once with a slight spring tension, to remove any sharp points. After one revolution has been made turn the left hand-wheel, which regulates the spring tension,

until a firm, even tension is obtained. A quarter turn will be sufficient, although this will be regulated by the number of lenses to be ground. A single lens will require only a very slight amount of spring tension, whereas two pairs can be forced a little more. The amount of spring tension used will regulate the speed of grinding, although the speed of the stone must also be correct.

Another centering device is constructed similar to a pair of tongs. This is held in the left hand, and opened by squeezing the handle together. In this type of machine the pattern or former answers also for the pad, having a rubber washer cemented on the face (Fig. 79). This pad also has holes to engage the pins on the centering device, and the first operation is to select the correct pattern, and place it in position

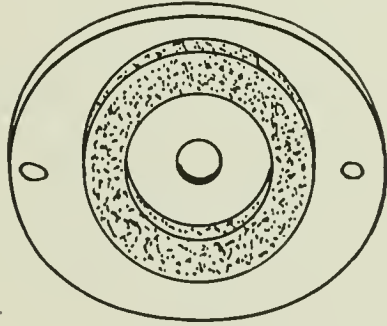

Fig. 79

in the centering device. The lens is then laid on this pad with the axis and center in the correct position, as before described in the other model. By releasing the pressure on the handle in the left hand, the lens is secured. This type of machine is opened by pulling the hand lever towards you a certain amount, to allow the lens to be inserted without striking. The spring is then hooked up by a chain, the links being so arranged that each one increases the spring tension. All other directions apply to this machine as well, except the size gauge, which is set by pointer instead of a micrometer arrangement.

Remember that in operating a machine the one point to keep in mind is to use plenty of water and do not allow the stone to run dry.

The tension should also be regulated according to the number of lenses grinding at a time. If too much is used for a single lens it will chip. The time necessary to grind a pair of lenses will vary from four to ten minutes, depending on the thickness and the amount allowed for grinding. Plenty of time should be given, however, because if they are removed before they are finished, the shape will be irregular. You can easily tell when they are finished by the sound. It is unnecessary to remove them immediately, however, as they can grind no smaller than the gage. After they are ground to size they must be removed and the sharp edges taken off the same as if ground by hand.

When the lenses are removed from the machine, they should be wiped immediately, or the grindstone grit is apt to dry on the surface, and when cleaned off it leaves marks resembling scratches. These are very difficult to remove, but they will come off with a wet cloth and fine pulverized pumice.

Lenses can be edged in the machine without cutting if desired, but this is of no advantage unless grinding for stock. Some opticians prefer to use their machines this way rather than allow them to stand idle, but there is no advantage in it, as interchangeable lenses can be obtained of the jobbers at about the same cost.

The greatest difficulty experienced in grinding by machine is the slipping of the lenses. This is caused by the pads becoming soft and greasy. It is a good idea when through with the machine for the day to place a piece of blotting paper between them to absorb the moisture and prevent sticking.

When placing concave lenses in the machine make sure that the pads between the lenses are thick enough, otherwise the edges will touch, causing them to crack.

If flat places or lines, called facets, are found on the edge, the stone is out of true and should be turned immediately.

Some prefer to use the frameless machine without a pattern, and when grinding this way the lenses must be watched to see that they are not ground too small. This method is perhaps quicker, but the machine requires constant attention.

In cutting, twice as much should be allowed on the ends as on the sides (unless your machine has a compensating device). For example, to grind 40×31 , the lens should be cut $41 \times 31\frac{1}{2}$.

Providing you do grind nearly all your lenses by pattern, it is often convenient to match odd or special shapes by this method.

CHAPTER VIII

DRILLING

Glass can be drilled in various ways, either with a hand drill or with power; with steel point or diamond; in an upright drill or in a lathe.

For drilling, a diamond is recommended, and this can be obtained in a white splint, carbon (black diamond), white turned diamond, or a turned carbon. A white splint costs about five dollars, although a better one can be obtained from six to eight dollars; carbon about ten dollars; white turned diamond about twelve dollars; turned carbon from fifteen to eighteen dollars. We recommend, however, the best white splint, as it has a rough point and cuts faster. It can also be sharpened at a less expense. Turned diamonds do not cut as fast, but are less liable to break. By using care, however, one need never break any diamond.

A diamond drill should run at from 1600 to 2200 revolutions per minute, but 1800 is recommended. If it runs too fast, it throws the lubricant out of the hole, and, consequently, runs dry. If it runs too slow, too much pressure is required. These two points are really the cause of all breakage.

Before starting to drill, see that the stop is set so that the drill point just clears the pin on which the lens is placed. There should be just space enough to slip a card easily under the drill point. The gage should also be set so that the hole will be the right distance from the edge. For regular flat lenses this distance is .093. Strong convex lenses will be drilled farther in, and strong concave lenses nearer the edge.

All lenses should be drilled, however, for a snug fit and then broached or filed the least bit for the variations of the strap. The most accurate way is to try the strap on the lens and mark it in the screw hole with ink, or better still, with a sharp steel point. (This can be made from an old rat tail file.) In most of the large shops the drills are arranged so that the pressure is applied by foot power, thereby allowing the use of both hands. This can be arranged very easily by drilling a hole through the bench and

attaching a wire to a foot pedal on the floor. After a little practice it will be found that the foot is just as sensitive as the hand.

There are a great many drilling fluids on the market, and, as these are cheap, we would recommend using one of them rather than going to the trouble of making it. The theory of a lubricant is to keep the drill cool, and in lapidaries water is used on diamond drills for drilling all kinds of stones. Turpentine, however, is supposed to soften glass, and for this reason it is used principally in making these preparations; "3 in 1 oil" is also used very successfully by many opticians. If you have an up-to-date drill, with a centering device, you will set the gage and place the lens in position between the four pins, apply the lubricant and place a slight pressure on the handle. Do not drill right straight down, however, but raise the drill constantly to allow the lubricant to flow into the hole. If it runs dry it will show a white powder and more fluid must be applied. This is the most particular point in drilling and must be watched constantly. The breaking of a drill is usually due to carelessness.

If you find that the lens has a tendency to vibrate, the point of the drill is out of true and should be attended to immediately. This is due to the breaking off of a small part of the stone, making the point out of center. This can be sharpened, however, providing the point is not too short. When buying a new drill, be sure that the setting fits the hole in the spindle perfectly. If it is small the set-screw will throw it out of center.

After the lens is drilled half way through, turn it over and drill from the other side. If it is drilled above center it will be necessary to change the gage governing the center device to the opposite side.

Torics cannot be drilled in a regular centering device unless it has a tipping table or other attachment to tilt the lens. If a drill is used without an attachment of this kind, the centering device should be removed and the lens held in the hand. The lens should be tilted up when drilling the concave side, and down on the convex.

Lenses can be drilled just as well without a centering device, but it is necessary to dot the lens. This can be done by the eye, or a separate centering device for marking can be obtained for a small sum.

A steel point will drill just as good a hole as a diamond, but it is necessary to sharpen it after drilling every few holes. A good point can be made from an old rat tail file sharpened to a long point, having two rounded sides. In grinding, however, be careful not to draw the temper. A steel drill should run much slower than a diamond, or from 600 to 800 revolutions per minute. The centering device should not be used, but the lens should be held in the hand, and, instead of being held rigidly, it should be rocked slightly to allow the drill to cut.

After you have drilled both sides of the lens so that the holes meet, it should be broached out. For this purpose a regular four-sided steel broach is used, and is fitted in one end of the idler shaft. These will have to be replaced occasionally, as they become dull and break the lenses. Some drills are supplied with a broach, similar to a rat tail file, but these are used in the same way.

Hand drills are not as satisfactory as power drills, but are used successfully, however, by opticians wishing to drill occasionally and who have no power. We recommend running these by a foot wheel, as better results can be obtained. The great difficulty with these drills is that you cannot get speed enough, and although a slow speed will do for a steel drill, it does not work well with a diamond. When using them, however, more time must be allowed for drilling, as it is not well to force it.

We frequently hear of cases where opticians require from three to five minutes to drill a hole. In cases of this kind there is something wrong; either the speed is not right or else the diamond needs sharpening. If a drill is working right a hole can be drilled in five to ten seconds.

Opticians often make the mistake of using a very long diamond drill. This is not necessary, and they are very liable to break. It is much better to use a short one for all ordinary lenses and have an extra one for thick ones. Do not forget that diamonds are not guaranteed against breakage, and if you get one that is not right, exchange it at once.

Although the drilling of glass is very simple, many opticians seem to experience quite a little difficulty in this work. The trouble may occasionally be with the workman, but more often it is the fault of his tools. To do good work and prevent breakage one should have a good drill. This not only means the dia-

mond or whatever kind of a point he may use, but the machine itself should be as good as can be bought.

All the best drills are fitted with centering devices and this feature alone not only assures one of accurate work, but saves a

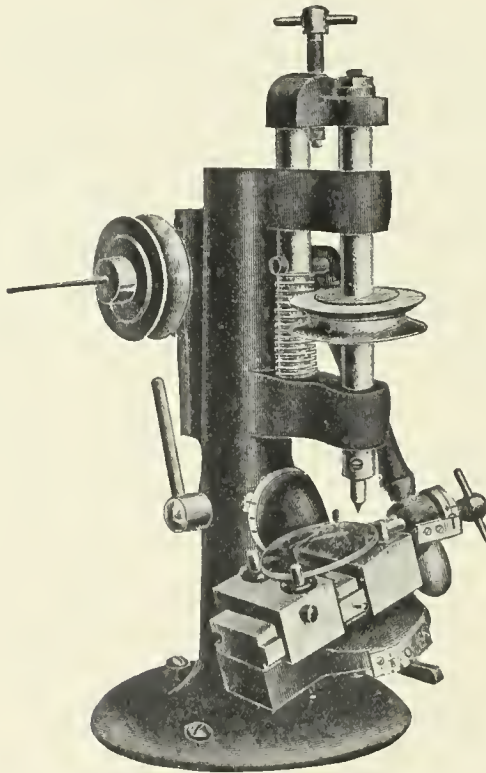

Fig. 80—Universal Drill (Standard Optical Co.)

great amount of time. We are illustrating a few of those in common use to show the method of using.

Fig. 80 is the Universal and is fitted with a tilting table for the drilling of torics. To drill a pair of flat lenses it is only necessary to open the centering device with the left hand and place the lens in position between the four pins. Be sure the lens is placed so that it touches all four, for if it does not the lens is not in straight, consequently the hole will be drilled off center. To guard against this it is well to open and shut the centering

device once or twice, so the lens may be jarred into position, so to speak. When it is secured between the four pins push the centering device to right with the left hand, until the edge of the lens comes in contact with the gauge. This should have been set at the correct distance previously.

With this machine is a small steel washer with several holes drilled at different distances from the edge, one side being for plus lenses and the other for minus lenses. These holes are numbered to correspond with those on the gauge of the drill. There is also a small pin furnished to insert in the holes in the strap. The idea of this device is that the holes in the strap can be measured and the gauge set at the proper distance. Most opticians, however, set their drills at the standard distance, which is .093 and for new work this will be correct, and on the old work the strap can be measured or judged as you prefer. Straps are made so accurate at the present time that very little variation will be found, and the old ones are usually so much longer that they can be detected at a glance and the necessary allowance made for them.

When the gauge has been set correctly and the lens pushed up against it, you are ready to drill. Right here it may be well to add a few words of caution in regard to the placing of the lens in position. In the first place be sure that there is a proper bevel on the edge of the lens, especially a strong concave. By this we do not mean that the lens must necessarily have a very conspicuous bevel, but on the other hand it must not have a sharp edge. If the edge is too sharp it will chip very easily and if perhaps it does not chip when placed between the pins it certainly will when pushed against the gauge.

Another point that must be looked after is, when a convex lens is being placed in position care must be used to see that the thin edge is not pushed under the gauge. This sometimes happens and even if it is not chipped, it will make the hole come too far from the edge. Care should also be used to see that every lens lies flat on the table and that one side is not tipped up, for when the drill strikes the surface of the lens it will naturally have a tendency to force it into position, and this also is very apt to cause chipping. Be sure that the lens lies flat on the little pad directly under the drill, as this is most essential and the fault of many of

the old style drills was that they did not have the correct bearing directly beneath the drill point.

If the lens is to be drilled on center it is only necessary to apply the pressure with the right hand, lubricate the point with drilling fluid and drill halfway through. Then turn the lens over and drill the opposite side.

At this time we will add a few instructions regarding the sound of a drill. Learn to drill by the sound of the point cutting the glass. Just as soon as the diamond point comes in contact with the surface of the lens a peculiar grinding noise is heard and as the pressure is applied and the point sinks into the glass this sound can be followed. As the ear is trained you can readily tell when the drill is halfway through the lens. The lens is then turned over and placed in position as before, but this time be sure that the hole is directly under the drill point. If the drill is accurate and if you placed it in the correct position in the first place there will be no trouble. If some mistake was made, however, the holes will not meet and a very poor job will be obtained. As the pressure is applied on the second side notice the sound as before and when the drill goes through into the first hole it can be detected instantly. In this way a lens is very rarely broken in the drilling, as the operator knows just when to release the pressure.

We have spoken of the sound, and though this is most essential we must not forget the hand or foot that applies the pressure. As one becomes experienced it will be seen that they seem to work together. In other words, it almost appears as if one could hear with the hand, as they work so in harmony.

When the hole has been drilled through it must be broached out, as will be seen by the accompanying illustration. This will also give an idea of the correct shape of a drill point. Fig. 81 shows the correct shape of a hole that has been drilled with a wedge-shaped point. In this way the hole is tapered and is rarely broken in drilling or mounting; also it is much more substantial when mounted. When it is run on the broach the center only is cleaned out and the hole is left as in Fig. 82. A hole drilled with a straight drill with a flat point, as in Fig. 83, is not only very liable to break in drilling, but also after it is mounted. In drilling when the two holes meet, the drill goes through with a jump, and the shock often breaks the lens. If it does not break in all

cases, a great many are chipped around the hole. When a hole of this kind is drilled and then run on the broach, it is also not only liable to break if it is not well lubricated, but it dulls the broach very quickly and a dull broach will cause more breakage than almost anything else.

Some of the interchangeable lenses ground at the factory often have fairly straight holes and these are drilled this way



Fig. 81



Fig. 82



Fig. 83

for the reason that they make better looking lenses. A countersunk hole, while more practical and always used in prescription work, does not make the best looking one, whereas a straight hole makes a neat looking lens.

In the prescription shops it is customary to countersink these holes a little, thereby taking off the sharp edges. A countersink can be made of steel, a rat-tail file will do, and should be ground to a blunt wedge-shaped point. This can be used in a lathe or by hand, by twisting it between the fingers.

In drilling above the center in this machine the lens is placed in position between the pins as before. After it is secure, release the catch in the front with the right hand and swing the table to the notch marked the amount you wish to drill above. Some of these are graduated in millimeters and others in inches; they can be had either way. The lens is then drilled halfway through, then

turned over and the catch turned to the opposite side, thereby swinging the table as before. It is perhaps safer and more accurate, especially for the beginner, to return the table to the central position after drilling one side. In this way one can see to the centering of the lens much better than when the table is set at an angle.

For torics the lens should be placed in position with the table in the central position and swung into position afterward,

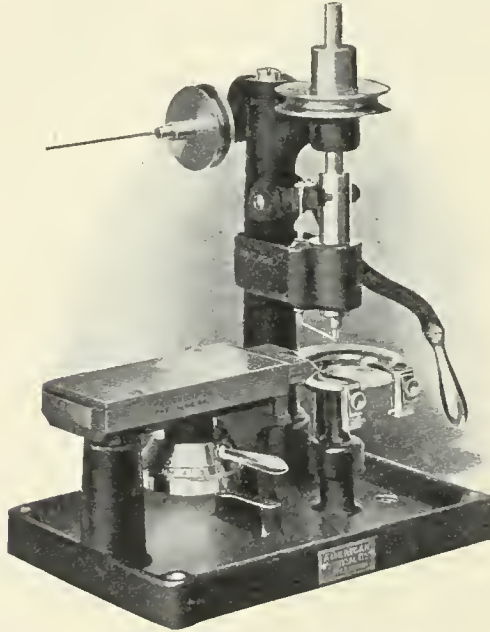

Fig. 84—Factory Drill of American Optical Co.

otherwise it is almost impossible to place the lens accurately with the table tilted upwards or downwards. The correct way is to tilt the table downwards first, then place the lens in position with the table in a central position. The table can then be twisted the desired amount. After drilling this side, tilt the table upwards and turn it to the central position for the centering, afterward twisting the table to the correct position for the hole to come directly under the drill point.

The A. O. Co. Factory drill (Fig. 84) is constructed somewhat differently, having an arrangement with two bent fingers,

if we may thus term them, instead of the four pins. At the left is a lever which is operated with the left hand to open the fingers

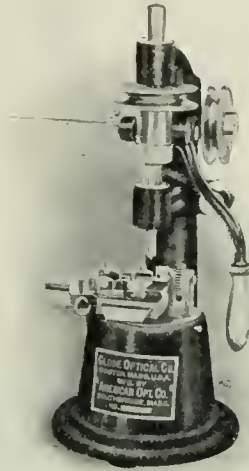

Fig. 85—Globe Drill

to engage and center the lens. Directly beneath this is a cylinder which is graduated for the drilling off center. The method of using this drill is to set it for the desired amount off center, then



Fig. 86—King Drill

with the left hand swing the table forward a little, opening the arms to engage the lens at the same time. The lens is then inserted and centered and swung back against the post or gauge.

Tories are drilled on this machine by raising and lowering two little slides on the front part of the arms.

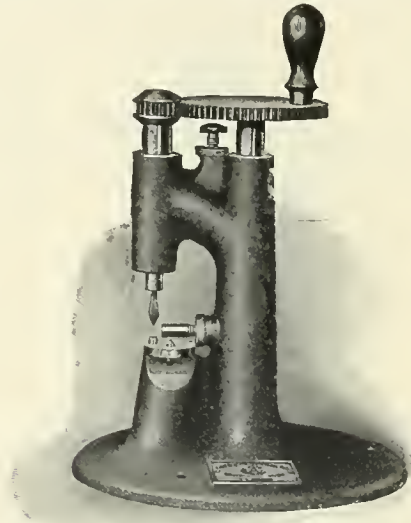

Fig. 87—Hand Drill

Drill Fig. 85 is one of the ordinary styles. The centering arrangement is constructed with four pins and is very simple. For drilling above and below it is only necessary to slide the table forward or backward the desired amount. For drilling torics the centering device must be removed, and the lens dotted for proper position of the hole.

There are many styles of power drills on the market, some having no centering devices at all. These drill just as well as the better ones, but more experience is required. One drill just recently placed on the market takes the place of a hand drill where no power can be obtained, as it can be run with dry cell batteries (Fig. 86). The regular batteries are used and the motor does not start until the lever is pressed downward.

There are many good hand drills. We are illustrating (Fig. 87) one of the higher-priced ones and some of these can be operated with a diamond drill if desired. The only difficulty experienced is that it is very difficult to obtain speed enough.

CHAPTER IX

MOUNTING

Mounting, or "setting-up," as it is usually called in the prescription shops, is a branch of the mechanical work that requires considerable experience. Almost anyone can screw a pair of glasses together, but this is not mounting in any sense of the word. The principal feature is to be able to fit a lens securely, with all the parts bearing properly, and yet so there is absolutely no liability of breakage.

Breakage is not only expensive, but causes more annoyance and delay than anything in the business. One doing this part of the work must necessarily be conscientious, whether they are working for themselves or for someone else. If one has one's mind on one's work, one can easily tell when the screw is inserted whether it is too tight or not. The trouble with most workmen is that the screw is driven home as if it were a piece of wood, rather than glass. When a strap is properly fitted it should be possible to twist it sideways just a little, until the last turn of

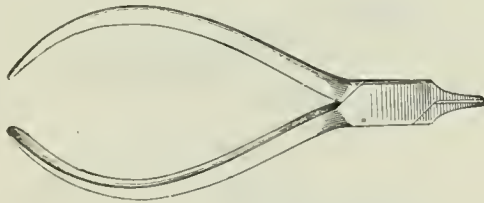

Fig. 88

the screw, or until it is set up. The last turn should make a snug fit. If the screw turns hard from the start, breakage is sure to be the result.

In order to do good work one must have good tools. There are many grades of pliers on the market to-day, and where formerly any pair that could be obtained in a hardware store answered the purpose we are now using tools that are made as good as surgical instruments. All jobbers carry regular optical pliers

in stock, and although the cost may be slightly more, they will last for years. These are well tempered and the round and snipe nose can be tapered to very fine points and still stand hard work.

The No. 35 strap plier is the most essential (Fig. 88). One pair will answer the purpose, but the best workmen usually have

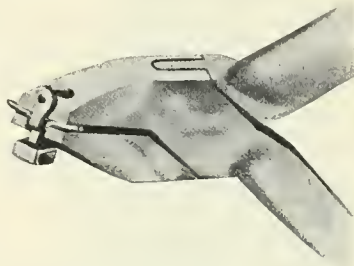

Fig. 89

two pairs, with different lengths of lips. Although these are made in one length, it is a very easy matter to grind off the lip slightly on an emery wheel, and then smooth it with an emery or buff stick. In this way one can have a very short one for the jobs that require very little fitting, and yet should be eased a little to prevent the strap bearing too tightly on the edges. The one with



Fig. 90

the longer lip can be used where the strap must be made considerably thinner. These pliers can be ordered from the jobber in this way if desired.

A new plier, known as No. 45 crimping plier (Fig. 89), has just been placed on the market, and this tool will not only be found very convenient in all shops, but it will prevent many lenses from being discarded. In drilling lenses it quite frequently happens that the hole is too near the edge, and also many times old lenses will be poorly drilled. When fitting a new mounting it is necessary to shorten the strap to fit it perfectly. This plier ac-

completes the desired effect at one operation, and in such a way that it cannot be detected.

The other necessity is the snipe-nose (Fig. 90). Round and flat noses are convenient for some operations, but can be dispensed with. The snipe-nose should be tapered almost to a point, and the inside of the jaws should be perfectly smooth and polished. The sharp edges should also be removed. This can be done with a



Fig. 91

fine emery stick with very little trouble. Under no conditions should a corrugated jaw be used, as this marks everything you touch with it.

We should advise all pliers to be purchased in nickel, as they not only look better, but are much smoother to handle. A medium size is also to be preferred, although many opticians are using the larger sizes. These are all right for bridge bending, especially for workmen with large hands, but as frameless straps are much more easily bent than bridges, the smaller ones are more convenient.

In mounting lenses speed is quite essential, especially if one attempts to do all his own work, as well as refracting. For this



Fig. 92

reason we are touching on some small points which may seem trifling, but it is just the knack of handling tools that makes one workman excel over others. In the large prescription shops the man who has the proper tools and knows how to use them, will easily be noticed by the way he handles them.

Cutting pliers are made in many styles. The older styles (Figs. 91 and 92), are just as satisfactory, as long as they are kept in good condition. The trouble in most shops, however, is that one pair of pliers is used for everything. To do good work one should have a pair of cut glass screws only, and keep them for that purpose. For cutting heavy steel wire and for the odd jobs, a heavier pair should be used. The Chappel cutting plier (Fig. 93),

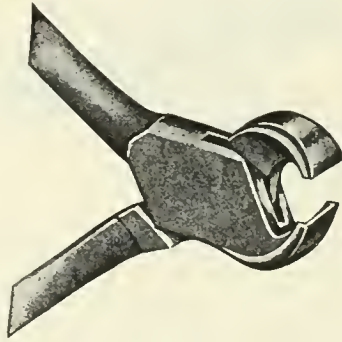

Fig. 93

is used extensively, as this cuts close to the strap, and requires no finishing. This plier is so constructed that the edges do not come together, and in this way they keep their cutting edge for a long time.

There are also several styles of spring cutters (Fig. 94) on the market, and the advantage of these is that the screw is not

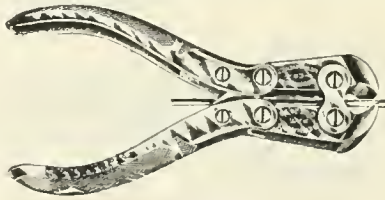

Fig. 94

cut with a snap. According to theory, a lens, if mounted properly, will not break when the screw is cut, but many of them cut with such a snap that the jar would naturally cause some breakage. Others have a tendency to crawl towards the strap, if the screw is cut too close, and thereby seem to pull the screws slightly.

Whatever plier is used, however, must be in good condition to do good work.

Rat-tail files (Fig. 95), should be of the best quality, and well tapered. Some are quite blunt, and cannot be inserted in the hole,



Fig. 95



Fig. 96

except at the top. A good file should be fairly small and should protrude through the lens about an inch. The cut is optional, but should not be too coarse. No. 0 is quite coarse, No. 1 medium, and No. 2 is as fine as can be used, and yet cut fast enough. If a coarse file is used care must be taken to prevent chipping.

A glass screw tap (Fig. 96) will be needed, not only to ease the thread in the stud, but also to insert through the straps and lens for a preliminary trial. It is well to have two of these, one to be kept for tapping the strap, and the other can be an old one; in



Fig. 97



Fig. 98

fact, one that has the thread worn considerably is to be preferred, as it is then inserted easily and quickly. If one has a tap plate these can be made without much trouble, but as they can be purchased from the jobber for about twenty-five cents it hardly pays. They are made usually from Stubbs's steel. They are threaded about one-half inch, and are then flattened on three sides, some-



Fig. 99

what tapering, then hardened. A broach holder (Fig. 97), or pin vise (Fig. 98), will be required to hold the tap, and those with the wooden handle are better for inserting through the strap and lens, whereas the regular pin vise is preferable for tapping the strap.

A swivel top screwdriver is the best for mounting, as in mounting it is necessary to turn the screw in and out usually several times. If a regular wooden handle spec screwdriver is

used, it requires more time, as a new grip must be taken at every half turn. In the prescription shops a man using a screwdriver of this kind would be so slow that he could never expect to hold his position. We are illustrating several styles of this in common use (Figs. 99 and 100), the wooden one being quite popular on



Fig. 100

account of its lightness. These should be used with the swivel in the palm of the hand, and not the way a watchmaker usually does. Many opticians have been watchmakers and, in fact, are doing watchmaking in connection with their optical business to-day; consequently, it is natural for them to get in the habit of using a screwdriver with the forefinger on the swivel, twisting the barrel between the next finger and the thumb. This in the optical business is quite awkward, and the work cannot be done as conveniently or as well.

If one uses the old style of cutting pliers it will be necessary to have a fine flat half-round file to finish the screws. The half-round is illustrated (Fig. 101), as this is better for bridges where the shank interferes. If the Chappel cutters are used, the file



Fig. 101

will not be needed. Many opticians use the screw-finisher in a polishing head, or lathe, and although these produce the best finish, it requires a little skill to keep them in shape. This will be explained later.



Fig. 102

There are many other tools that are in use that can be added to this equipment, if they suit the individual taste. Among these are the No. 39 plier for angling the straps of studs or temples; the cushion pad, on which the lens can be placed when inserting the screw, and hand broach, a hand countersink; also a hand tap-

ping machine. A very convenient thing is a large size tap with a quantity of large glass screws for repairing old straps where the thread has been stripped, and an Ajax wrench (Fig. 102), with screws and nuts for Ajax straps. These nuts are sometimes used when the thread in the strap has been stripped, and also as locks for the glass screws. Buff sticks and wheels are used by some opticians to finish the straps, but now this is usually dispensed with.

It is well to have a good assortment of screws. This should include gold, gold-filled and German silver, in regular length and extra long, also Ajax and the large size, as these are used on



Fig. 103

repair jobs almost entirely. When fitting new lenses to old gold mountings the optician can hardly afford gold screws, and the filled answer the purpose just as well. A complete assortment of screws, in glass bottles, can now be obtained in a neat little case (Fig. 103). These are inexpensive and are not only convenient, but save considerable waste. When a stock of screws are carried in open boxes or envelopes they are sure to get mixed, and often upset and lost.

Before trying the lens in the strap it will be necessary to remove the screws from the mountings, and as these are inserted at the factory by machine, they will probably work hard. The screw holes should then be tapped out so that the screws enter easily.

After the holes in the lens are drilled and broached and the

studs tapped, the next operation is to try the strap on the lens. If the lens is thinner than the strap it will fit into the bottom of the strap. Notice whether the parts of the strap that bear on the edge conform with the curve of the lens. If not, shape them with the snipe nose pliers. Then take an old tap or a pin about the same size and insert it in the screw hole so that it passes through the glass into the screw hole of the opposite strap. If the lens has been drilled properly, it will be just a little too tight. Now remove the glass and file the hole just a grain toward the edge of the glass with a rat tail file lubricated with drilling fluid. Insert the lens again and try a second time. If an old tap is used

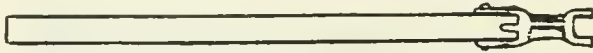

Fig. 104

it acts the same as a screw, so that when it is screwed into the hole you can easily judge whether it is too tight or not. If it appears the least bit tight do not try to force it, but remove it and file the hole a little more. For this reason a small metal screw-driver, with a swivel top, is recommended, rather than a wooden handle one, as you do not get such a good purchase on the screw. You can then tell readily if it binds. One of the greatest mistakes is made in forcing screws in the mountings, as this is responsible for most all the breakage.

When the tap enters the hole easily and there is no play, the screw can be inserted, and as it is turned in try the strap and see



Fig. 105

Fig. 106

if it is tight. When a strap is properly fitted it should be possible to twist it sideways just a little until the last turn of the screw, or until it is set up. The last turn should make the snug fit. If the screw turns hard from the start, the hole in the glass should be filed a little more.

We have now taken it for granted that the lens and strap were just the right thickness (Fig. 104). If the strap is too

narrow the lens, perhaps, will go in but half way. We then take the strap plier and insert the plain jaw in the strap and the jaw with the hook on the outside (Fig. 105). With a slight pressure the strap will be widened a little, and if the lens is still tight repeat the operation on the other side of the strap. This operation was formerly done with a snipe nose plier before the invention of the strap plier. The great difficulty experienced with this tool was that the straps were thrown out of alignment and it was necessary to square them up and tap them over again. With the strap plier this is not only unnecessary, but the work can be done much more quickly.

If the lens is thinner than the strap the plier is inserted with the hook on the inside and the plain jaw on the outside (Fig. 106). This will make a slight kink in the strap, very close to the lens-bearing parts, which is hardly noticeable. In selecting straps, however, it is best to use one that is a little snug and open it with

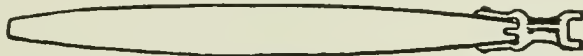

Fig. 107

the strap pliers than to use one that has to be made much narrower. A convex lens is, of course, thicker at the screw hole than at the edge, and for this reason the strap will be made narrower at the bottom (Fig. 107), otherwise it will twist sideways. A concave lens is just the opposite, and the strap should be made narrower at the screw holes with a snipe nose plier. The lens should be inserted on the side at the thinnest part and slipped along to the screw hole. In fitting strong lenses, especially concave, see that there is a good bevel on the edge near the screw hole to prevent flanking.

If the hole has been drilled too near the edge it will be necessary to bend down the lens-bearing parts and a little variation does not matter materially, but if there is any space to speak of these ears should be bent with a slight kink near the post (Fig. 108). This can be done with the strap pliers, but care should be used not to take up too much. Under no circumstances bend the points down, leaving an opening between the lens and the strap (Fig. 109), as this will work loose almost immediately. In some cases where the strap has been opened as much as it will stand

in fitting strong concave lenses, or if the workman does not have a pair of strap pliers, it will be necessary to file the edge of the lens to allow it to go into the strap, but this method should not

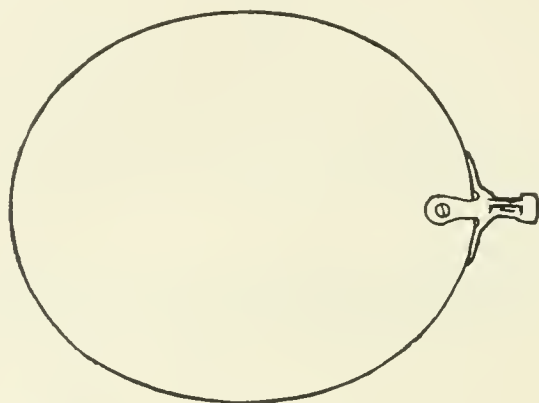

Fig. 108

be used unless absolutely necessary. It is, however, desirable to do this on strong concave lenses.

In fitting torics the strap should be bent with the snipe nose

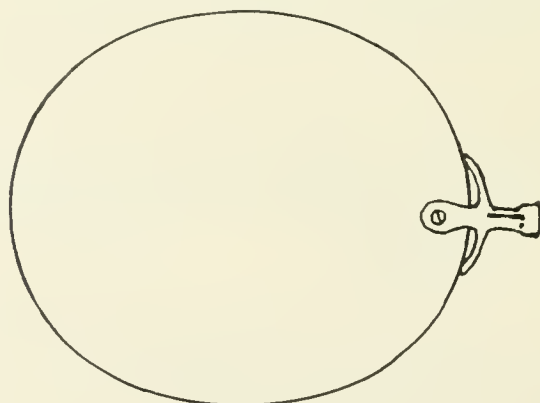

Fig. 109

pliers to conform to the curve of the glass (Fig. 110). Although this is really no more difficult, most opticians prefer to send the mountings to the prescription houses and have these lenses

mounted, as the lenses are expensive, and if one is broken it takes away the profit. Occasionally an old pair of lenses is sent in to be fitted with new mountings and the holes are so large that it is impossible to fit a strap so that it will look well. In cases of this kind a plug of tinfoil or of wood can be inserted in the hole nearest the edge of the lens and this will take up the space between the lens and the lens-bearing parts of the strap. There are also strap tighteners on the market for this purpose.

There is also a device on the market supposed to prevent breakage and this is used when fitting expensive lenses, such as fused bifocals. This consists of a rubber tube and a glass screw, with a long pin on the end of the threaded part. After the screw is set up it should be cut off and finished. If a screw finisher is used the end should be left a little long to allow for rounding. If it is cut too short the tool will cut into the strap. If you do not use a screw finisher, cut the screw fairly close and file the



Fig. 110

end with a flat file almost down to the strap. A piece of cardboard, or a brass plate having a square place cut out for the strap, should be used to lay over the glass to prevent the file from scratching. There is also a new plier on the market for this work which cuts the screw so close that it does not require filing.

If the optician does his own drilling he can, of course, drill lenses to suit himself. There are, however, a great many who order lenses drilled and do the mounting themselves. Many of these opticians believe that lenses should be drilled so that all that is necessary to do is to screw them into the mounting. If lenses were drilled this way a great many would fit too loose, and a poor job would be the result. The right way is to have them all a little snug and then fit them as before described. To do this a complete set of tools is necessary and care should be used in fitting. If the optician would only realize that men doing the mounting in prescription jobs are the most expert optical workmen and have spent years learning the trade, there would not be very many complaints regarding the drilling.

The mounting of frameless lenses is a trade in itself and too much care cannot be used in selecting the thickness of lenses and straps. The strap plier has simplified the mounting of frameless lenses wonderfully and some opticians have a wrong idea of this tool. It is not only designed to bend a strap from 2 mm. to 4 mm., or *vice versa*, but it should be used in place of the snipe nose plier in fitting almost every lens. In large shops the men mounting rimless work have two pairs, one with a short hook for the regular jobs and one with a long hook for extreme cases.

There are opticians who have an idea that all frameless lenses should be so accurately drilled that no fitting should be required. Although lenses are drilled to a standard gauge and straps are milled the same, it is impossible to have them fit perfectly. A slight variation in the size of the diamond point will change the size of the hole; also some lenses are countersunk and others are drilled straight, as before explained. As a rule, if all lenses were drilled so they could be readily screwed into the strap, the strap would work loose. In order to give good satisfaction to the wearer the lenses should be perfectly tight, and yet not so snug that breakage will be the result. If one is in the habit of ordering lenses from the prescription houses, unmounted, he should expect to do a certain amount of fitting, and in order to do this he should have a proper equipment of tools.

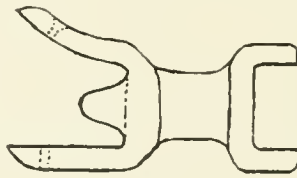

Fig. 111

We have already explained in preceding articles the method of adjusting the strap with strap pliers. Many opticians still use the old method of bending the strap with snipe-nose pliers, however, and although on the average the work is not so well done, we will give an explanation.

The strap, of course, should be slightly wider than the lens, but just enough so the lens will slip in easily. If it is too wide, grasp one side of the strap with the point of the pliers in the

middle and bend it slightly outwards. This will make a slight kink near the lens-bearing part (Fig. 111). Now bend it backward to its original position and you will find that it has made the opening slightly narrower. By repeating the operation on the other side of the strap both sides will be alike and the strap will be made uniformly narrower. The strap should then be sighted endwise, to see if the sides of the strap are parallel, as in bending

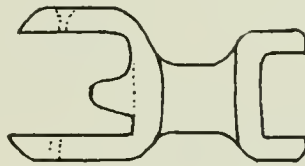

Fig. 112

them with a plier of this kind, they are very apt to be out of alignment. After bending them parallel the screw holes should be tapped, and this will also have a tendency to bring them in line the other way. It is very necessary to have the strap in as perfect condition as possible, for if it is bent out of line in any way breakage is sure to be the result.

One of the great advantages of the strap pliers is that they accomplish this result without altering the original alignment of the strap. This operation is for convex lenses (Fig. 28) and in making the inner part of the strap narrower we prevent the lens twisting. If this is not properly done, or the lens is fitted in the strap with the jaws parallel, it is possible to hold any eyeglass or spectacle by grasping both lenses and twist it out of shape. This, in many cases, is the cause of lenses flaking near the strap.

If the strap is too narrow it must be opened to admit the lens sufficiently, and yet not bind on the edges. In most cases concave lenses require this operation and it is very difficult to fit them properly, without the strap binding on the edge of the lens, if it is not done with a strap plier. In opening the strap grip one side as near the bottom as possible; that is, near the lens-bearing part, and open the strap outwards as before. Remember, however, that for the convex lenses we grip it near the middle, whereas for concave we grip it as far back as possible.

When the strap has been spread on one side (Fig. 112) grip

it near the middle and bend it back to its original position. It will then be noticed that this side has been somewhat rounded out. By repeating this operation on the opposite side quite a little extra width can be obtained. Sight the strap endwise and straighten as before explained.

Some of the newest style bridges have an invisible foot; in other words, the shank is soldered in a depression on one side of the strap. In this style it is practically impossible to bend the side on which the bridge is soldered and, consequently, all the variation must be made on the opposite side.

In doing this the strap will be shortened somewhat and it will probably be necessary to file the hole slightly to prevent the

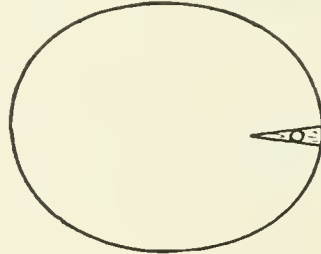

Fig. 113

screw binding. If the lens is concave and it is found that it binds slightly in the bottom of the strap, it will be well to file the edges slightly, to allow for the rounding of the strap.

When filing a lens lay it on the edge of the bench perfectly flat, with the hole towards you. Hold it with the left hand and with a rat-tail file which has been dipped in drilling fluid file a V-shape slot from the hole to the edge of the lens. Unless a very fine file is used, this will cut very rapidly, so care must be used not to get it deeper than is necessary. A little filing on both sides is to be preferred, rather than all on one side. Care must also be used to see that the point of the file does not cut on the opposite side of the hole (Fig. 113), as this makes a very bad looking job. In doing this work always use a rat-tail file, as this produces a V-shape slot and takes off that part of the glass that binds. It must be remembered, however, that in filing a lens it is weakened considerably, and with the strap pliers it is very rarely necessary. If this must be done, however, take off as little as possible.

In fitting concave lenses where the strap is wide enough to take the lens without filing, the strap can be bent edge-shape and the lens inserted on the thin edge, and you can then slide it around to the hole. In this way the strap is right down into position and requires no bending. When the edge must be filed to take the lens it is impossible to do this, consequently the strap must be forced over the edge. A pair of pliers with one long curved jaw (Fig. 114) is very convenient to press the strap into position after the lens has been inserted.



Fig. 114

If the hole has been drilled too near the edge the lens-bearing parts must be bent down to conform to the curvature of the lens. This operation has been described with the regular pliers, but the No. 45 crimpling plier now accomplishes this result with one operation and in such a way that it cannot be detected. This is

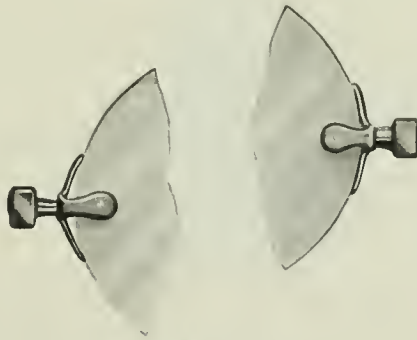

Fig. 115

made with a slot in one jaw, which is inserted over one side of the strap. It is also shaped to fit the lens-bearing parts. The opposite jaw has an opening which fits around the post, and when the pressure is applied, it forces the lens-bearing parts downward, thereby shortening it slightly. When the lens is inserted no open-

ing can be seen, as it is covered by the side of the strap. The accompanying illustration (Fig. 115) shows a poorly fitted strap; also one that has been formed with this plier. It is impossible to say too much regarding the fitting of straps, as the number of poor jobs in use to-day is almost a disgrace to the profession. In the last few years the work has been greatly improved, however, and this is especially noticeable when one considers the number of straps and other devices that have been placed on the market to overcome this defect.

Ajax straps do not have to be bent in this way. If the side of the strap (there is but one in this style) has been bent backwards the tendency is to bend the lens-bearing parts down, the same as a regular strap, but this way is incorrect. By bending the side upwards a little—in other words, make the angle of the side of the strap and the lens-bearing parts more acute, the lens

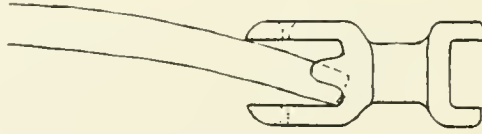

Fig. 116

will fit properly. If the hole in the lens is just the right distance this should be a right angle, but even if it is not, it will make no material difference.

Some opticians grind off the edge slightly when the hole has been drilled too far from the edge. This not only requires extra time, but also changes the shape of the lens slightly. It is much better and more convenient to file the holes, as it cannot be detected and is just as strong.

In mounting many workmen have their own peculiar ways of fitting straps. For example, if the screw binds slightly at the start the pressure can be relieved by pressing firmly with the side of the screwdriver on the end of the stud or strap. This forces the lens-bearing parts back slightly and frequently the screw will then turn easily. If there is a slight opening on the sides these can be closed up with a slight pressure of the snipe-nose pliers on the strap. Pliers for this purpose can be made by grinding out the inside, so there is no danger of edge-chipping by the

jaws of the plier. These little points are referred to only to show how it is possible to increase the speed, but they are somewhat dangerous for the inexperienced.

TORICS

Toric are no more difficult to mount than flat lenses, provided that the strap is bent as described in our previous articles. All other instructions relating to flat lenses apply to this form of lens also. Do not, however, attempt to fit a toric lens into a strap that has not been shaped to fit. We see so many fitted as in Fig. 116 that a word of caution is necessary. By studying this drawing for a moment one can easily see the causes of so much breakage in mounting these lenses.

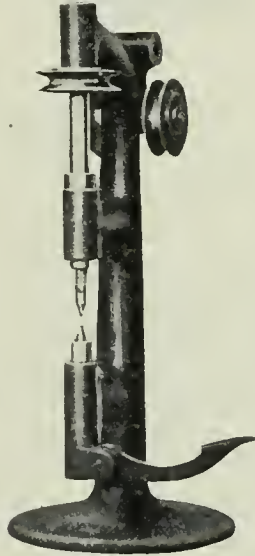

Fig. 117

The best method of finishing the ends of screws is with a screw finisher. There are two kinds on the market—the upright (Fig. 117), which resembles the ordinary drill press, and the horizontal (Fig. 118), which is similar to a buff head. The upright supports the screw a little better, perhaps, but the horizontal is quicker. In using these machines the screw should be cut a little long, and if the ordinary cutting pliers are used the bevel on the

jaw will leave them about the right length. If the close cutters are used see that they are not cut too short. When holding the screw up to the cutters place the forefinger or thumb against the screw-head to support it somewhat and rock the glass slightly to prevent the screw cutting to a point. The condition of the knife will also have considerable to do with the shape of head. The knife should

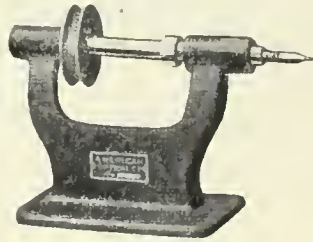

Fig. 118

be honed with a very small oil stone, having a rounded edge, and kept as sharp as possible. When inserted in the holder it should be adjusted so that it will cut just enough to make a half-round head.

If the horizontal head is used it must be run left-handed, or in other words, from you. All the cutters are made to cut this way and many are out of use to-day that have not given satisfaction, for the reason that they have been run the wrong way. It must be remembered that buff heads run toward you, so for this reason it is necessary to have a separate machine for the screw-finisher. The advantage of finishing screws in this way is that it requires no polishing and also forms a slight burr on the end of the screw, and, according to theory, it should not work loose as quickly. Under any condition, take pride in having your work done well and in such a manner that if it is taken to a competitor for repairs it will bear inspection and cannot be criticised.

CHAPTER X

BIFOCALS

Cement bifocals are still the most commonly used, for the reason they are the lowest in price. The trade, as well as the public, are fast becoming educated to use the better lenses, however, as the wonderful increase in the sale of Kryptoks will show. We find the sale of stock cement bifocals decreasing, although just as many cements are made in the prescription shops.

The first step in making a pair of cement bifocal lenses is to select the stock. The distance lenses will be written on the prescription and although any form of lens can be used, it will make considerable difference in the price of some combinations. It is also desirable to place the wafers next the eye, if possible, as it makes the reading segments more invisible. The idea of advertising invisible bifocals has not only proved profitable to the trade, but has improved the workmanship on the cement bifocals and, incidentally, driven the Perfection and Split bifocals from the market.

When making a pair of sphericals, periscopic distance lenses are selected; first, on account of the better form, and secondly, on account of the uniform curvature of the inside surfaces. This surface on American ground lenses is always -1.25 on periscopic convex lenses, and $+1.25$ on the outside of periscopic concave lenses. With concave lenses it does not make so much difference, as we will show later. On account of the uniform inside surface of pex. lenses, the factories adopted a uniform stock of wafers, having a $+1.25$ surface on one side, and the balance of the power on the other. These are known as "regular wafers" and are ordered by this term. They are also the lowest price wafers that are manufactured.

We will take, for example (Fig. 119), a prescription distance $+2$, reading $+3.50$, or it may be written, distance $+2$, add $+1.50$ for reading. We select a pair of pex. lenses $+2$ and a pair of regular $+1.50$ wafers. These wafers will be $+1.25$ on one side and $+.25$ on the other, the $+1.25$ curve will be cemented, of

course, to the -1.25 surface of the distance lenses. After these are cemented, it must be remembered, the contact surfaces (that is, the -1.25 and the $+1.25$) do not have any effect on the power of the reading portion. We simply add the powers of the outside

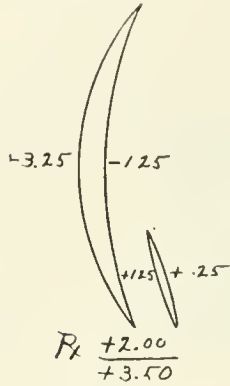

Fig. 119

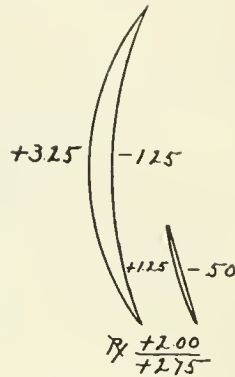

Fig. 120

surface of the distance lens and the outside surface of the wafer, to obtain the reading power. In this prescription the distance lens being $+2$ and having an inside surface of -1.25 , must, of course, have an outside surface of $+3.25$. The outside surface

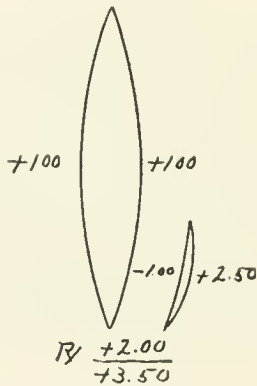

Fig. 121

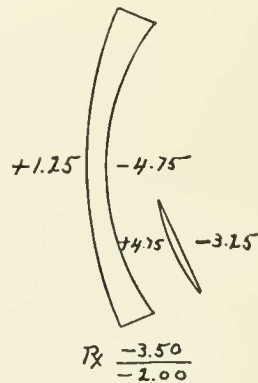

Fig. 122

of the wafer being $+.25$, we have the desired $+3.50$ power. Many opticians seem to experience quite a little difficulty in figuring these wafers, but if the contact surfaces have no effect, except that they must be the same in order to fit so they can be cemented,

there will be no trouble. Take, for example (Fig. 120), a prescription with $+ 2$ distance and $+ 2.75$ reading. The wafer in this case will be $+ 1.25$ on one side and $-.50$ on the other. This is really a compound wafer, but as the factories are obliged to furnish all combinations of "regular wafers," you really obtain them at the same price.

Now suppose we had selected for the first prescription (Fig. 121) a pair of double convex lenses for distance $+ 2$. There would have been $+ 1$ on each side, and to fit a wafer we must have one with a $- 1$ surface. This could not be selected from the stock of regular wafers, as there would be no such combination. As we must have this curve, it must be surface ground, and to make the required addition of $+ 1.50$, we must have on the other side $+ 2.50$. We then have a combination of $- 1 = + 2.50$, and this we call a compound wafer, for the reason that this form is used to fit to compound lenses. It can readily be seen that the price will be the same as if fitted to compound lenses, and although the distance lenses cost no more, the extra expense of the wafers makes the job cost more than is necessary. Many times a prescription is sent to the prescription houses, either ordering double-convex cement bifocals, or else the optician fits a pair of double convex lenses to the frame, and sends them in to have the wafers fitted, and then is unable to understand the extra charge.

It should always be remembered that cement bifocals in convex sphericals should always be ordered pex., or if no specification is made they will be made in this form, unless for some reason double convex is wanted, in which case the extra charge will be made. As before stated, periscopic concave lenses are all made with a $+ 1.25$ outside curve. It does not make a desirable form to fit wafers to the outside of these lenses, so all wafers are fitted on the inside, consequently they must be ground to order. For example, we will take (Fig. 122) prescription distance $- 3.50$, reading $- 2$, the reading lenses of course always being the weaker. As the outside curve is $+ 1.25$ we must have on the inside $- 4.75$. To fit this surface we must have a $+ 4.75$ surface on the wafer; the other surface will then be $- 3.25$. The combination of the wafer will then be $- 3.25 = + 4.75$. This is a compound wafer, consequently costs extra.

Now suppose we select for this same prescription (Fig. 123) a pair of double concave lenses — 3.50. These lenses will be — 1.75 on each side, and as the power of the wafers is to be + 1.50, and one surface must be + 1.75 to fit the — 1.75 surface, we must

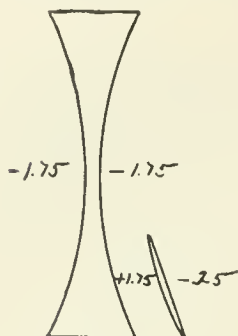

$$\begin{array}{r} Rx \quad -3.50 \\ \quad -2.00 \end{array}$$

Fig. 123

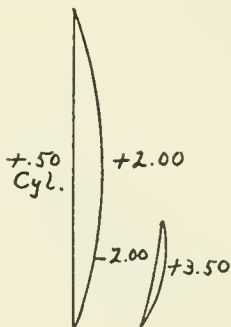

$$\begin{array}{r} Rx \quad +2.00 = +.50 \text{ cyl.} \\ \quad +3.50 = +.50 \text{ ax } 90 \end{array}$$

Fig. 124

have a wafer + 1.75 = — .25. This is also a compound wafer and must be ground to order, the same as the first form. In this case it will be seen that it makes no difference in the expense whether they are made in the double concave or periscopic concave form. As this is true of all combinations of concave cement bifocals, as well as those having a concave distance and convex reading, it makes no difference as far as the expense is concerned, which way they are ordered. As the periscopic form is to be preferred and there is no difference in the expense, it is better to make them this way.

Cylinder cement bifocals require what are known as "plano wafers." As cylinders have one side plano the wafers must necessarily be ground in such a form that one side will be plano and these surfaces must always be cemented together. Under no circumstances can a wafer be cemented to the cylinder surface of a lens, as this will destroy the cylinder effect. Although it is generally understood that two surfaces to be cemented must be the same curve, we often find surfaces cemented that are not the same and occasionally we find wafers cemented to the cylinder surfaces. According to theory, this is impossible, and if it is

possible to make them hold for a while they will usually come back in a very short time to be re-cemented. When a job is received by a prescription house, with the complaint that the cement does not hold, the surfaces are first inspected to see if they are correct, and in many cases poor contacts are the cause. In selecting wafers for cylinders no trouble will be experienced, for the power is entirely on one side. For example, a + 1.25 plano wafer is + 1.25 on one side and plano on the other. It will be noticed, however, that a + 1.25 plano wafer and a + 1.25 regular wafer are the same.

Compounds require special wafers, as has already been stated, and although these seem to give more trouble to the optician, they are really just as simple. If one point will be remembered, it will help to simplify the figuring of these wafers, and that is, always write out the distance and reading correction in full, and the surfaces will be right before you. For example, take a prescription distance + 2 = + .50 ax. 90, add + 1.50 for

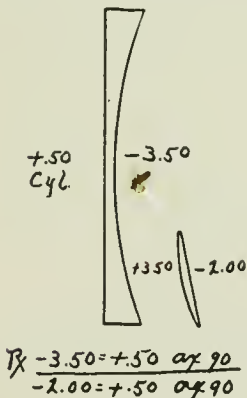

Fig. 125

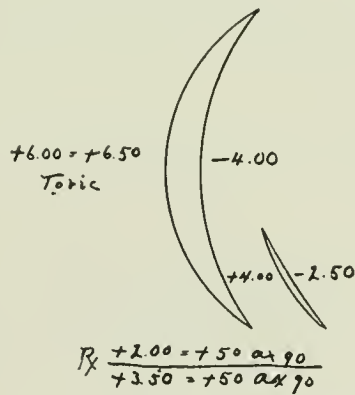

Fig. 126

reading. If we attempt to figure the surfaces of the wafers from this prescription it is somewhat difficult. If we write the prescription (Fig. 124)—

$$\begin{aligned} \text{Distance } + 2 &= + .50 \text{ ax. } 90 \\ \text{Reading } + 3.50 &= + .50 \text{ ax. } 90, \end{aligned}$$

we already have the inside and outside surfaces figured. You will remember that the contact surfaces have no effect, consequently all we have to do is to select a wafer to fit the +2 surface

of the compound, which will be -2 ; the other surface will be the reading power, which is $+3.50$. As the two outside surfaces will give the reading power, it will be seen that the outside surface of the wafer is $+3.50$ and the outside surface of the compound is $+.50$ ax. 90 , and we have the reading correction, $+3.50 = +.50$ ax. 90 . This is true of all compounds whether $+ = +$, $- = -$, $+ = -$ or $- = +$, and to illustrate, take for example (Fig. 125) prescription distance $-3.50 = +.50$ ax. 90 , reading add $+1.50$. This prescription will be as follows:

$$\begin{aligned} \text{Distance } -3.50 &= +.50 \text{ ax. } 90 \\ \text{Reading } +2 &= +.50 \text{ ax. } 90. \end{aligned}$$

The wafers will have a $+3.50$ surface to fit the distance lens, and -2 for the reading power. When cemented the outside of the distance lens will be $+.50$ ax. 90 and the outside of the wafers -2 ; hence we have the reading correction $-2 = +.50$ ax. 90 . In making compound cement bifocals it is customary to fit the wafers next the eyes, whenever possible, in order to make them inconspicuous. The rule in most prescription houses is to

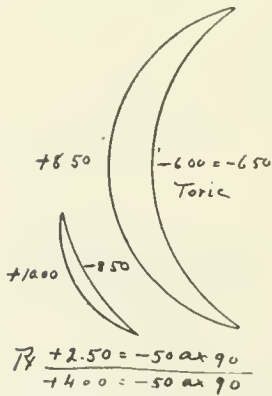

Fig. 127

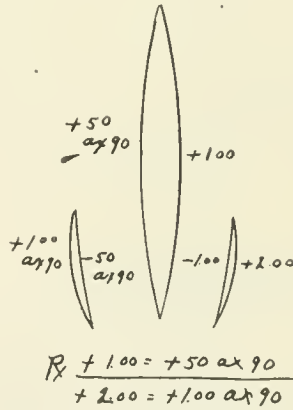

Fig. 128

place them inside, whenever the reading power is less than $+4.50$, and when it is stronger it is placed on the outside. It is necessary to use your judgment, however, it being poor form to place a $+ = -$ compound or any lens having a concave surface, with the weaker surface out.

Torics are somewhat more complicated, unless the prescription is transposed so the spherical surface is inside. If the prescription is not written in this way it should first be transposed and the rest will be simple. For example, take (Fig. 126) prescription distance $+ 2 = + .50$ ax. 90, reading add $+ 1.50$, this will be

$$\begin{aligned} \text{Distance } + 2 &= + .50 \text{ ax. } 90 \\ \text{Reading } + 3.50 &= + .50 \text{ ax. } 90 \end{aligned}$$

The distance lens if ground on a $+ 6$ curve would be $+ 6 = + 6.50$ on the outside and $- 4$ inside. To fit this surface we must have a $+ 4$ curve, as the power of the wafer is $+ 1.50$; we subtract this from the $+ 4$ and we have $- 2.50$. By then referring to the outside surfaces we find that the distance lens is $+ 6 = + 6.50$, and the wafer is $- 2.50$. The difference between the $+ 6$ and $- 2.50$ will give the reading power of $+ 3.50 = + .50$ ax. 90. In this case it will be seen that the $+ 6$ base curve must always be considered, consequently the reading power is always obtained by fitting a wafer with the outside surface having a curve of such a power that the difference between this surface and the base will equal the reading prescription. If this prescription (Fig. 127) had been written distance $+ 2.50 = - .50$ ax. 0, reading add $+ 1.50$, with the request that it be filled as written, and not transposed, we would be obliged to fit the wafers on the outside. This form of lens would have $- 6 = - 6.50$ on the inside, and $+ 8.50$ on the outside.

As we have already explained, a wafer cannot be cemented to the cylinder surface, as it will destroy the cylinder effect. The outside surface being $+ 8.50$, it will be necessary to have $- 8.50$ surface on the wafer to fit, and as the whole power of the wafer must be $+ 1.50$, the other surface will be $+ 10$. We then have the combination $- 8.50 = + 10$. It will be seen these are extreme curves and are not only hard to surface-grind on account of the extreme thinness, but will be just as hard to edge and cement. A job of this kind is not only more expensive, but as a rule a number of wafers are broken before a perfect job is obtained.

In making toric bifocals it is always preferable to transpose the combinations so a spherical surface can be obtained on the inside, even though it is a weak curve. If the spherical of the

distance lenses is very strong the full inside curve can be obtained by using a + 9 D. base.

All combinations of torics are worked out in the same way and if all combinations will be transposed to a form having a + cylinder there will not alone be less trouble in figuring the wafers, but the curves will not be extreme.

Occasionally we are requested to make a pair of bifocals (Fig. 128) as follows: Distance, + 1 = + .50 ax. 90; reading, + 2 = + 1 ax. 90. This combination has a different power cylinder in the reading correction, and although it may be contrary to the rule and unnecessary, it can be made by fitting two (2) wafers, one on each side. As the contact surfaces do not count, the outside surfaces must be ground to produce the desired effect. We must first have a surface — .50 ax. 90 to fit the + .50 ax. 90; on the outside we will then grind + 1 ax. 90.

This makes a wafer with two cylinder surfaces, and this is not only difficult to grind, but is very expensive. The other wafer will be a regular compound form, having — 1 contact to fit the + 1 sph. surface of the compound, the other will be + 2. We then have the reading correction, + 2 = + 1 ax. 90. It shows that a combination of this kind is obtained by an error in the refraction, as astigmatism is constant and does not change for reading.

Cross cylinders cannot be made in bifocals and these combinations should be transposed to compounds and wafers fitted in the regular way.

CEMENT BIFOCALS

In making cement bifocals the distance lenses are ground the same as usual, except that when grinding to frame they should be left a little large, or about 1 mm. between the joints. The wafers are about 30 mm. round in the rough, and if the prescription is such that one wafer can be used for two, it should be split in the center, using a hand diamond or a sharpened rat tail file. They can, however, be edged in quantity in the frameless machine before splitting, but care should be used not to screw them in too tightly. It is not practical to attempt to edge less than a pair. If ground in this way they will be left 28 mm. diameter and then cut in the center.

It is always advisable to center wafers when possible, and if the prescription reads, for example, distance + 2, reading + 4, the power of the wafer is equal to the distance. As a spherical lens is practically two prisms with the bases together, by fitting the wafer with a thin edge upward and the thick downward, the



Fig. 129

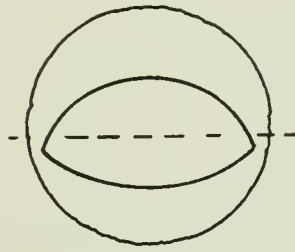

Fig. 130

prismatic power is neutralized (Fig. 129). When the power of the wafer is stronger than the distance, it is necessary to cut it nearer the center to obtain less prismatic power, consequently two wafers must be used. When the power of the wafers is weaker than the distance lens, it will be cut as far from the center as possible, to obtain all the full prism power.

It is, however, practically impossible to vary this very much, as the wafers are not large enough. The only way that this can be obtained is to grind prism wafers. It is not absolutely necessary to do this as a little variation in the center does not matter much except that the centers must always be on the same horizontal plane. In other words, do not have one center up and the other down, as one wafer centered and the other not, as this will cause the patient quite a little discomfort perhaps, and when they return, complaining, you will be at a loss to know the cause of the trouble.

When fitting plano wafers to cylinders with the axis at 90° , always cut them from the center (Fig. 130).

After the outside edge is finished (leaving the bottom rough) it is ready to be cemented. Clean the distance lens and the contact surface of the wafer carefully with alcohol. Put a

small drop of cement on the lens and place the wafers in position. Hold the lens over an alcohol flame, or if gas is used, a Bunsen burner. Do not use a white flame, as it will smoke the lens. An ordinary wood spring clothes pin is very convenient for holding the lens, or tweezers can be used. Heat the lens gradually until the cement boils, then remove it from the flame and allow it to cool; at the same time place the wafer in position with a stick or tweezers, being careful to press out all bubbles. When it is cool, see that it is firm and cannot be moved. If so, the cement was not cooked enough. If it appears yellow when laid on white paper, it is cooked too much and burned.

There is another method of cementing where the cement is prepared first and in this way it is necessary to cook a quantity of cement in a jar slowly. It requires quite a little experience to get this just the right consistency. The cement should be cooked so that it is quite thick, applying it to the lens with a stick. With this method it is only necessary to warm the lens and spread the cement evenly over the surface as though it was ordinary



Fig. 131

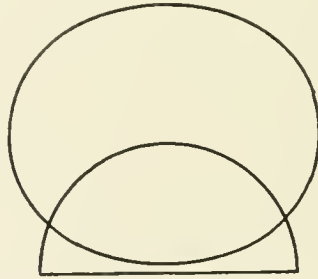

Fig. 132

liquid glue. The wafer is then placed in position and allowed to cool.

Strictly speaking, all wafers should be set in 1 mm. toward the nasal side, although this is not necessary when using large wafers. The smaller styles, such as the horseshoe shape, should be cemented in this way.

CONCAVE BIFOCALS

In making concave bifocals the wafers should be cut so that the thickest part is upward (Fig. 131). This is to neutralize the prismatic effect of the distance lens. After the wafer is properly placed and the lens is cool (Fig. 132), the lower edge can be cut off, using a pattern the shape of the distance lens. It is then beveled, if for frame, and ground down to size; if for frameless, it is ground to conform to the shape of the distance lens and beveled slightly to take off the sharp edge.

The lens should then be cleaned with alcohol, or naphtha if preferred. If it is then found that the cement has started, warm the lens slightly and the spots will probably disappear.

FRAMELESS CEMENT BIFOCALS

In making frameless cement bifocals it is a good plan to drill the lenses before cleaning, as this prevents the drilling fluid working under the wafer. Wafers should always be fitted to frameless lenses if possible before drilling, as there is less liability of cracking.

CEMENT BIFOCALS

The grinding and cementing of a bifocal has already been described, but it may be well to add a few points. Either a composition or Craigleith stone can be used, although a Craigleith is preferable, not grinding as fast. Wafers should be very thin, and when using a fast-cutting stone care must be used to prevent them grinding away too fast, and thereby producing a poor shape. As a rule, wafers come from the factory with very clean edges, but even if they are more or less irregular it is unnecessary to cut them, unless, of course, the center is to be used.

In the majority of cases where the wafers are split in two before grinding there is very little difficulty in shaping them up. If they are ground separately be particular to see that the shape is uniform. The regulation size is 28 mm. diameter and the height is varied according to the width of the distance lens, although usually from 13 to 14 mm. high. The rule is to set the top of the wafer about 2 mm. below the center of the distance lens, although if worn constantly a lower wafer is more satisfactory. This depends entirely on the patient, and to a large

extent, the purpose for which they are to be used. For example, a bookkeeper who is using them almost constantly, a large wafer may be preferred (Fig. 133), whereas a person doing very little close work and who uses them only occasionally for near work, will prefer them very small (Fig. 134).

Wafers can be obtained from the jobbers all edged, ready to cement, and the regular size is 27×13 . To obtain this size when doing your own grinding it is necessary to grind them

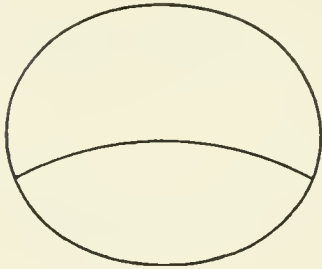

Fig. 133

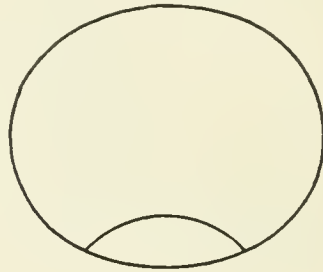

Fig. 134

28 mm. diameter, as before stated, for the reason, when cemented to the base lens, the bottom part will be cut off, thereby making them smaller.

The principal difficulty the beginner finds, after he has learned to cement, of course, is in placing the wafer. If the lens is placed on the bench squarely in front of you, after it has been heated; or in other words, the cement has boiled, it will require some few seconds to cool. During this period there is plenty of time to move it around and place it in position. After training the eye it will soon be a simple matter to get them fairly accurate, and when one is placed just where you want it you will then have a pattern for the second lens.

If after allowing it to cool somewhat you find when laying one over the other they do not match exactly, there is no harm in warming one or the other slightly and moving the wafer to the proper position. It is a very simple matter to get the wafers a different size in cementing by placing one higher than the other, even though they may have been ground alike. One-half a millimeter difference is very noticeable (see Fig. 135). This cannot be done many times, however, as either the cement will be cooked

too much or else the cement will be squeezed out so it will be too thin. In this case bubbles or air spots are very likely to appear and it will then be necessary to take the lens apart and start all over again.

When the lens is finished and a bubble or base spot appears it is sometimes possible to warm the lens slightly, and this will

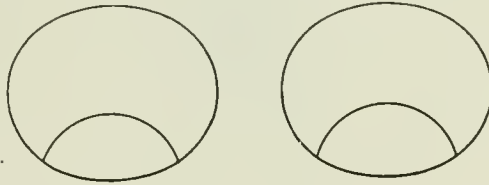

Fig. 135

disappear. It should first be tried without applying any pressure to the surface of the wafer, and then if this does prove successful it will do no harm to press the wafer down a little. It must be remembered, however, that a lens should be heated but slightly; in other words, just warmed. For this work the regular tweezers have always been used, but recently there have been improvements made which are quite a help. Fig. 136 shows an improved tweezer, which holds the wafer in position while cementing; it does not, however, assist the workman in placing the wafer. Fig. 137 is a more complicated form, which can be termed a gauge.



Fig. 136

This tool is constructed so that the jaws can be spread to allow the insertion of the distance lens. This can be set squarely so there is no difficulty in placing the wafer in the correct position. By the use of the scale at the bottom the wafer can be centered or decentered accurately. All wafers should be decentered in from 1 to $1\frac{1}{2}$ mm. to allow for convergence, but the large majority are placed in the center. The lever *D* is used to apply the pressure to the surface of the wafer, to cause the bubbles to disappear.

Electric heaters (Fig. 138) are now used to a great extent in bifocal work, as the heat is more even and can be regulated at will. These are inexpensive and can also be used for inserting

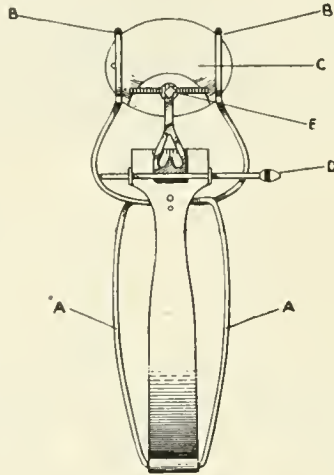

Fig. 137

lens in rubber, zylonite or shell lorgnettes, as well as eyeglasses and spectacles. This heater is almost indispensable in Opifex work.

OPIFEX BIFOCALS

The Opifex bifocal is a form of cement bifocal, which has a wafer ground extremely thin by a patented process. Where



Fig. 138

these wafers were formerly ground only by prescription shops licensed by the patentee, they are now ground by the American Optical Company and the Bausch & Lomb Optical Co., and supplied the same as stock lenses. These are ground on a thick

"backing," so that they can be edged as easily as any lens, or if preferred, they are supplied edged. Figure 139 illustrates one of these wafers in the rough, although the edge is nearly perfect, being as sharp as a knife edge and perfectly round.

These wafers can be edged by hand fairly well, but the shape must be looked after very carefully. In grinding it is only necessary to grind away the backing and simply touch the edge of the wafer as slightly as possible. This will clean off any trace of rouge and at the same time take out any minute chips. Opticians who have edging machines will find it to their advantage to have special small pads made to accommodate these wafers and by grinding them by machine a great deal of time will be saved, and also insure a perfectly ground wafer. Figure 140 shows the wafer edged and ready to cement.

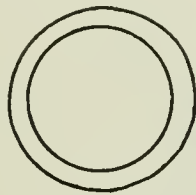

Fig. 139



Fig. 140

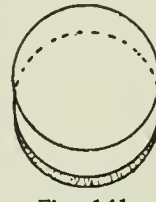

Fig. 141

Before cementing it will be necessary to ascertain which surface is cemented to the backing.* In some cases the contact surface will be upward, and in others it will be cemented to the backing. For this reason it requires two different methods of handling. If the contact surface is up it should be cleaned and placed on the heater to warm it slightly. As this requires but a few seconds the base lens can be cleaned and placed on the heater at the same time. With a small stick or a pair of tweezers the wafer can be pushed off the backing slightly (Fig. 141) and after the cement has been applied to the base lens, grasp the backing and turn it over so that the wafer will be downwards and apply it to the base lens (Fig. 142). By then holding the wafer with the stick the backing can be removed and the wafer then placed in position. With the electric heater this operation can be done entirely on the iron plate, but if an alcohol lamp is used care should be taken not to heat the wafer too much or it will crack.

*The Geneva lens measure, constructed especially for measuring wafers, is essential to measure these curves accurately.

If the contact surface is cemented to the backing it is unnecessary to clean it, but simply start the wafer from the block, as before described, and transfer it to the base lens without turning it over. If the wafer has been surface-ground in this form it is possible to bevel the edge slightly before transferring it, but this is not really necessary. It must not be done if the contact surface is upward, however, as the bevel will be on the wrong side. If for any reason the contact surfaces should show any specks of dirt after they have been cemented, the wafer can be transferred to

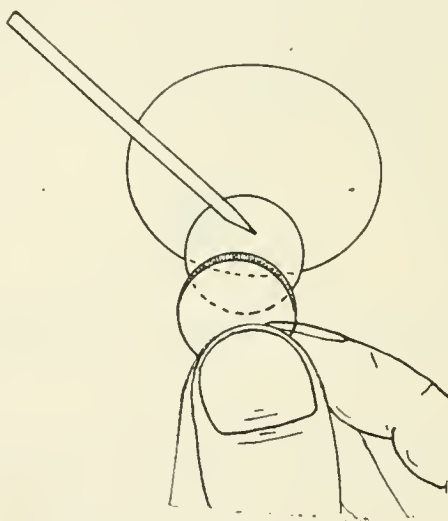

Fig. 142

another lens, or backing, cementing it, of course, in the regular way. It does not matter if the surfaces do not fit, as the cement will have body enough to allow the contact surface to be cleaned. In recementing old lenses it is necessary to transfer them in this manner, to clean off the old cement. Be sure to heat the lens sufficiently so the wafer is moved easily, otherwise when starting it the wafer will crack and a part remain on the base lens.

After the wafer has been transferred to the base lens it should be placed in position and cleaned slightly. It will then be necessary to neutralize the reading portion, as it may be found wavy, or not the correct focus. It must be remembered these wafers are extremely thin, consequently are easily bent.

As it is necessary to hold the wafer with a stick when sliding off the backing it is not unlikely that the center was pressed down, thereby making the power .12 to .25 D. weaker, or possibly wavy. By heating the lens slightly and, if necessary, moving it around gently, there will be no difficulty in producing a perfect lens. Do not, under any circumstances, attempt to make these lenses without neutralizing the reading portion after heating each time. This also applies when recementing these lenses, and if the prescription does not accompany the job neutralize them before removing the wafers and make a note of the focus. When the wafers are in the correct position and neutralized correctly the bottom can be cut off and edged the same as any cement bifocal.

In cleaning be very careful not to chip the edges and when wiping always wipe away from the edge of the wafer and not towards it. If the wafer should become chipped it can be transferred to the backing and ground out. Do not attempt to grind or clean the wafer when not on the backing, as this is practically impossible.

Some opticians are making a specialty of thin wafers ground the shape of the Opifex, but only slightly thinner than the regular cement bifocals. Wafers for this purpose are ground small in surfacing—usually about 22 mm. diameter. They are then edged to 18 mm., which is the usual size. While this can be done it does not produce a very satisfactory lens and at the same time requires more time. It will be found cheaper in the end to purchase the Opifex, and they not only make a perfect job, but are much simpler to handle.

For Opifex work "cooked" cement will be found more convenient and it also simplifies the work considerably. When the cement has been prepared so that it requires no attention it is possible to do better work on the lenses. With this method each job is cemented alike, and if the cement has been properly prepared you are reasonably sure of them giving satisfaction. The method of preparing cement has been described in previous articles. Occasionally we hear of substitutes for fir balsam, but as yet there is nothing on the market that is particularly satisfactory. All of these preparations adhere to the surface of the

lenses, so they either become more or less opaque or else the wafers cannot be removed.

A wafer having the same appearance can be ground from a regular wafer, and this is called the horseshoe shape. It is no more invisible, however, on account of the thickness. If special wafers are ground for this purpose as thin as possible, and from 22 to 25 mm. diameter, it is possible to make a very fair job. The prescription houses usually charge 50 cents extra over the regular cement price for these lenses. The best way to handle these is to stick them to the end of a stick, about the size of a pencil, with sealing wax. They should be edged carefully

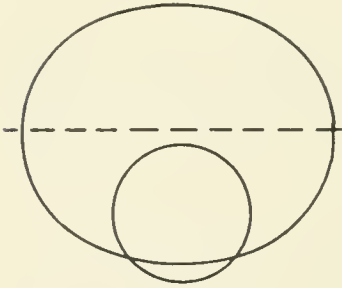

Fig. 143

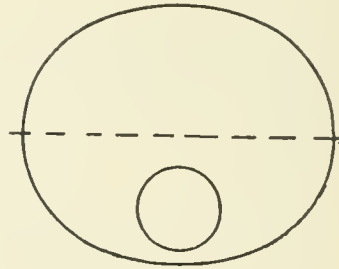

Fig. 144

to 18 mm. diameter. They are then cemented to the distance lenses in the regular way, but so that the top will be 2 mm. below the center of the distance (Fig. 143). After the lenses are cool, the bottom is cut off and ground, as usual. There is an occasional call for round wafers, usually about 10 mm. diameter. These can be ground in the same way, but cemented to the distance about 2 mm. from the lower edge (Fig. 144). Oval wafers are also ground in the same way.

PERFECTION BIFOCALS

Perfection bifocals are made by grading out the lower portion and inserting the reading lens. The distance lens is first ground to size and the lower part cut with a hand diamond and a round pattern. It is then carefully broken out and ground on a small alundum stone. These stones can be obtained to fit any buff head and in any size. The regulation shape is one inch

diameter, although occasionally, when a larger lower is desired, $1\frac{1}{4}$ inch is used. The lower lens is then cut the same shape and ground on the regular stone to fit this curve. Although these can be ground into the frames separately, it is better to stick them together with white sealing wax. If this method is used, the wax must be left in (and this is no objection). If cleaned out the lens will be too small for the frame.

Grooved Perfection bifocals have been used to some extent and the advantage claimed is that the parts are interchangeable and can be made up from stock very quickly. The line between the distance and reading is quite conspicuous, however, and for this reason they have never had a large sale, especially since the demand for invisible bifocals.

The distance lenses can be ground the same as the regular Perfection, except that the curve is beveled instead of flat. This can be done on the small stone without any difficulty. The lower part is then ground flat to fit the curve of the upper and a groove made with a rat tail file and drilling fluid.

Perfection bifocals are rarely used except in cases where a patient is obliged to work near heat and cannot afford the fused lenses. It is also impractical to make them in frameless.

SPLIT BIFOCALS

Split bifocals can be centered or not as you prefer. Ordinarily they are not, and when ground in this way the four pieces can be cut from two lenses, providing the power is the same in both eyes. The lenses are first split in the center and the straight edges ground on the side of the stone. Composition stones are molded and the sides are usually smooth enough. If not, the right side should be honed the same as the face. If a Craigleith is used the side will have to be turned true with a diamond and honed with a piece of Craigleith. When the straight edges are ground and beveled slightly to take off the sharp edge, they should be stuck together with white sealing wax. They can then be handled as one lens and cut to size with a pattern. They are also ground the same as any lens. These lenses can also be ground separately if desired, but it is more difficult to hold them when trying in the frame. If centered lenses are required the

halves should be cut from the center of the lens and a pattern having this shape will be required.

Whole bifocals are surface ground and are treated the same as an ordinary lens when ground to size. These are not recommended on account of the prismatic effect.

FUSED BIFOCALS

Fused bifocals are a surface-grinding proposition and will be described under that heading later. The blanks can be obtained and if care is used it is not difficult to surface them. At present, however, we will suppose that you prefer to buy them uncut and edge them yourself. When ordering them from the jobbers, full information must be given, such as distance and reading powers, diameter and height of reading portion, axis, frame or frameless, if reading part is to be set in and size of eye. When the lenses are received the axis should be marked and a cutting line drawn. The reading portion is then dotted with ink around the edge so that the circle can be seen easily. The usual diameter is 18 mm., and the height is within 2 mm. of the center. After the axis and position of the disk is inspected the lens is cut by pattern. Although these lenses can be edged by machine, it is recommended that they be ground by hand. The position of the disks can then be watched and there will be less liability of spoiling them. Also be particular that the disk is not scratched as flint is much softer than crown glass. In edging these lenses the disks should be first considered; that is, the shaping of the lens should be done on the lower edge first to make the disks the same height. After these have been made just right, proceed to shape up the other part of the lenses. In making the various combinations it is necessary to use flint of different indices and some of these grind quite hard. For these lenses Craigeleith stones will be found more satisfactory.

CHAPTER XI

BRIDGE BENDING AND TRUING

Bridges can be bent before or after mounting, and, although there is really no preference, some opticians obtain better results one way and some another. When bending an unmounted frameless bridge, or a frame before the lenses are inserted, gripping pliers can be used to hold the strap or eye wire so that the operation is simplified. An experienced person, however, can bend just as well after mounting, but the bridge must be held in the fingers. Under no circumstances should the spectacles be held by the lenses as they will surely be broken.

Bridge bending is not hard to learn, but simply requires practice and a good eye. It is discouraging at the first attempt, and the reason is that the beginner starts to bend some frame to certain dimensions, probably selecting a difficult one, and possibly one that could not be bent successfully anyway. In starting this work, select some old frames of soft metal, such as German silver or Roman alloy, as these make the best frames to practice on, and always have some dimension to work to, as nothing can be accomplished by bending at random.

For the first operation take a frame, say 60 mm. P. D., and bend it to 58. This is done by holding the bridge with a pair of No. 36 pliers in the left hand and gripping the shank of the bridge with a pair of round or snipe-nose pliers about half way from the eye wire to the turn, and, with a slight twist to the right, the eye is bent toward you (Fig. 145). Then grasp the shank near the eye wire and bend the eye back, and you find that the shank has the desired bend and the eye has been thrown in quite a little. The amount, of course, depends on the twist.

After bending this to the required P. D., bend it back again to the original shape. This will give you practice in widening the P. D. This is accomplished by straightening the shank with a pair of snipe-nose pliers; in other words, take out the curve known as the 47 style. In this operation the eye is thrown forward and it should then be brought into line with the No. 36 pliers.

A frameless bridge is bent the same way, except that it is necessary to have different pliers to hold the strap, and for this purpose the No. 39 angling pliers are the best (Fig. 146).

Next try raising and lowering the bridge. This is done by holding the eye-wire with the No. 36 pliers or the snipe-nose in

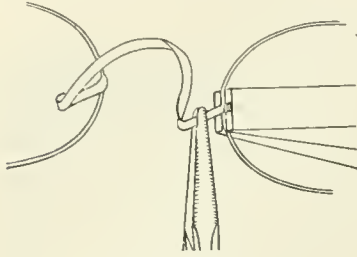

Fig. 145

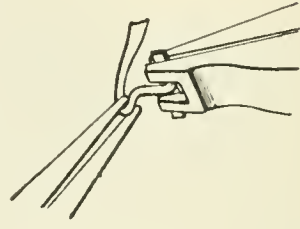

Fig. 146

the right hand and, grasping the crest of the bridge with the thumb and forefinger of the left hand, bending it up or down. This, of course, changes the angle of the crest a little, also the inset or outset, still it is the first step necessary (see Fig. 147).

If you desire to lower the bridge and keep the angle the same, bend the bridge down, as described in Fig. 40, then grasp

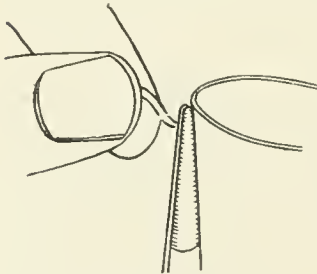

Fig. 147

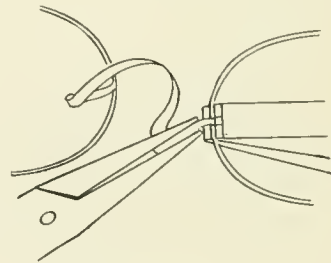

Fig. 148

the frame with the No. 36 pliers (if frameless, the No. 39 pliers) in the right, and the shank of the bridge with a flat-nose pliers in the left hand, bend the shanks downward (see Fig. 148). It is impossible to raise the bridge and keep the angle of the crest and the inset or outset the same, except by shortening the shanks, and this should not be attempted until the first operations are mastered.

To widen the base take a pair of flat, or snipe-nose pliers, and place a piece of cloth between the jaws to prevent marring the bridge, and flatten it to the required measurements and shape; then straighten the frame and you will find that the bridge is right, but the P. D. is wide. The shank can then be bent, as explained before, to shorten the P. D.

To increase the outset it is necessary to shorten the shanks, and it is quite difficult to do this without marring the stock, but if you go slow, bending a little at a time, this can be done all right. The first operation is to grasp the bridge with the thumb and forefinger of the left hand and, with a pair of round pliers in the right hand, gradually open up the turn, beginning with the

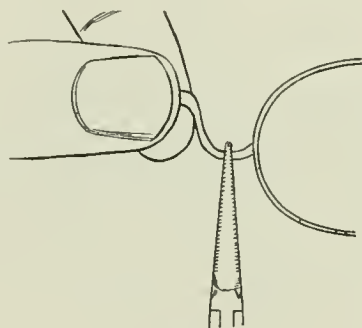

Fig. 149

small end of the pliers and gradually sliding the bridge toward the larger part of the pliers (see Fig. 149). After this has been spread sufficiently, grasp the shank a little way from the turn and bend the eye straight, at the same time pulling forward on the bridge with the left hand. This pulls a little of the stock in the shank into the arch. It can then be trued up and the operation repeated on the left side.

To decrease the outset or increase the inset the shank must be lengthened and the first operation is to open the turn of the shank a little, as before, but, instead of grasping the shank back from the turn, grasp it near the turn, or, if possible, in the turn, bend the eye straight and true up. Repeat the operation on the left side.

After practicing with the sample frame select a good frame

to bend to measurements. The principal part of selecting frames for prescription jobs is in using good judgment, and you should train yourself to judge whether a frame can be bent to the dimensions required or not. If you do not learn this you can never learn to bend and will spoil stock, also waste time. In

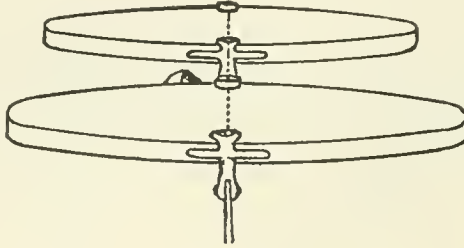

Fig. 150

selecting a frame try and get everything right but one dimension, if possible, and it is best to change the P. D., as this is easier than anything else. Do not take up a frame at random and expect to bend it to fit the required dimensions, but study it carefully and learn to judge it before touching it with the pliers.

After the lenses are mounted they must be trued up, and, if the bridge has been bent previously, it is a very simple operation. If it has not been bent it is best to straighten it somewhat and lay it on the pupilometer to get an idea of what is to be done. The first operation is to get the lenses in the same plane, so that they will lie flat. Then turn the spectacles over, holding them endwise and sight across the outside surfaces. The four glass screws should then be brought into line (Fig. 150). The spectacles should then be measured for all dimensions and any necessary alterations made at this point.

We now suppose that the front is correct and true, and the attention turned to the temples. First straighten and true them so that the curve will be uniform. Then hold the front endwise with the temples upward, and in almost every case they will be found with one angled one way and the other in the opposite direction (Fig. 151). A pair of parallel jaw pliers (No. 40) should then be used to grip the endpiece close to the strap or eye-wire, and, with a pair of snipe-nose pliers, the joint is angled to make the temple perpendicular (Fig. 152). The temple is

then shut down, and, if it is not in line with the endpieces, it is turned to the right or left, both pliers being used in the same position. This operation is then repeated on the other joint. If the front is to be angular, the joints are tilted in the same manner.

Should it be necessary to set the temples back, the tip can be filed at the joint if gold or steel, but in gold filled it is better to hold the joint with a pair of pliers and pull the temple outward with the fingers. Although one may be broken occasionally, it saves filing the gold, which is very important when handling filled goods. There are no pliers on the market for holding the endpiece in this operation, but they can be made specially for any make or style of joint.

In truing eyeglasses there is very little to be done except to straighten the lenses so that they are in the same plane, and adjust them so that the droop will be right. This is a very important feature and many opticians do not understand that an eyeglass should be placed as far back on the nose as possible. A great many times a patient requests that the spring be tightened, when in reality it should be opened more to allow the guards to

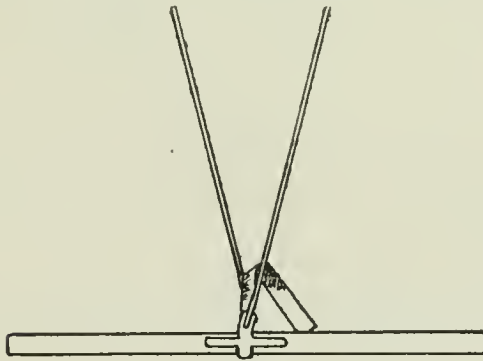

Fig. 151

go back farther. Each time the spring is tightened the glasses are thrown farther forward and, finally, they will grip only on the very edge. Now, in truing, the lenses are allowed to droop a little so that when placed on the nose they will be horizontal. If they were in this position before placed on the face, or if the guards are not spread enough, the lenses will set upward. This

not only looks badly but the lenses will be too high. A great many times eyeglasses are sent to the prescription houses for drop studs or guards to set the lenses lower, or even for new lenses drilled above center, when all that is necessary to make the glasses right is to droop the lenses a little more.

When lenses are drilled above center they must always be turned down. For this operation grasp the stud with a pair of stud pliers in the right hand and hold the spring with the left. By bending the spring away from the lenses it will give them the required droop. Then take hold of the studs with both hands

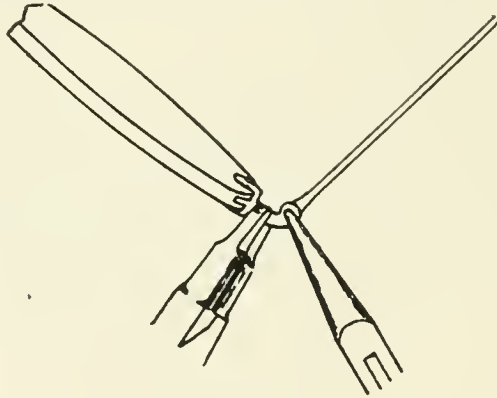

Fig. 152

and open the spring a little until the lenses appear to be in about the right position. The guards should then be adjusted so they are parallel.

For truing a fingerpiece mounting use the No. 40 pliers, placing the jaw marked "top" with the large hole over the head of the screw on which the spring is coiled. The lenses can then be changed to any position without damaging the mounting (Fig. 153).

When it becomes necessary to drop the lenses in an eyeglass frame to make them lower on the face, the screws should be loosened in the end-pieces and the lenses twisted so that they set upward considerably. Then grasp the studs with the stud pliers in the same manner as before described for frameless, and twist the eye downward, etc. If the lenses need to be raised, they

should be twisted downward in the frames, the studs grasped with the stud pliers, and the spring bent backward toward the lenses, thereby raising the eye to the required position. This is another case that occurs frequently in prescription work where

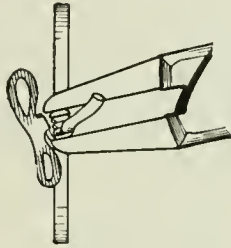

Fig. 153

frames are ordered with studs above center. If the lenses are fitted, they can be adjusted easily and no explanation is required; but if the frames only are ordered, it is almost impossible to shape them so that they look right, and, even if this is possible, the optician can easily change the position in fitting them up.

Toric lenses can be adjusted so that they curve slightly to conform to the features. If there is too much curve, however, it may be objectionable to the patient. It is well to remember this point, as frequently people complain that they are unable

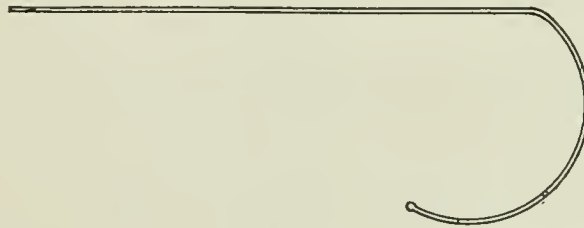

Fig. 154

to wear torics, and, if the glasses are adjusted so that the angle is changed, it makes them entirely satisfactory.

This also applies to the angle for reading, but not so much with torics as flat lenses. According to theory all glasses should be angled slightly, and the amount depends somewhat on the features.

Lenses should never be drilled below center. If the spectacles are too low on the face, the bridge can be altered to raise them even if it is necessary to make one to order. It is seldom that a regular bridge cannot be used by dropping the shanks.

If eyeglasses are too low they should be raised by changing the guards to some other style. In many cases a regular offset guard with a short blade will accomplish this result. It should be remembered that to raise the lenses the guard should be lower, and to lower the lenses the guards should be higher.

There are so many guards on the market that it is well to look the common styles over, and it will be noticed that the arms are set very differently on different styles. If one is familiar with these styles it is a very easy matter to select a different one to accomplish whatever result is required. When there is difficulty in fitting glasses so that they will be low enough, the drop eye lenses sometimes are a great help, especially when the eyes are deep set.

In truing temples do not leave too much curve to them, but have them so that they will be straight to the turn so that all the curve will be behind the ear. The right way to fit a temple is to make quite a sharp turn at ear (Fig. 154). These not only prove more comfortable but they look better. When the nose is sensitive, cylinder bridges, cork or shell nose guards can be used, but when fitting the latter the bridge must be somewhat higher to allow for the thickness of the cork or shell.

CHAPTER XII

SURFACE GRINDING

Surface grinding is, in reality, a separate branch of mechanical optics, for the reason that few opticians doing their own work attempt to do this work. Usually an optician puts in a plant to do his own edging, and for this part of the work he has time enough, but it is not practical to attempt to surface the few odd combinations that he may be called upon to supply and attend to his trade at the same time. The right way is to install the outfit for edging, and, as his work increases, he can afford to hire a man for this part of the business. He can then install the surface plant for the accommodation of his customers or for the advertising feature.

It requires very little time to grind an ordinary lens if the workman is efficient, and it often saves a delay of twenty-four to thirty-six hours if it is necessary to send out of town to a jobber.

A surface machine can be obtained for \$58.50 and upward. The simple machines have one speed, and although this is sufficient, it is often convenient to have two speeds (Fig. 155). If one speed only is used, 900 to 1200 revolutions per minute are most satisfactory. If two speeds are used, 600 and 1200 are the most common.

A lens can be ground using almost any speed, but, of course, the higher the speed the faster the grinding, although it requires more attention as it is also necessary to feed the emery faster. There is a limit as to speed, however; if it runs too fast it throws the emery off quickly and you then are grinding on the tool, and in this way nothing is accomplished. It must be remembered that it is the emery that grinds and not the tool.

The electrical-driven machine is very convenient as the motor is enclosed in the base, and, consequently, does not require countershafts or belts (Fig. 156). It also not only requires very little power to operate it, but when the machine is stopped it is using no current. These machines can be obtained in direct current only at present. There are also automatic surface machines on the market, and these can be used either by hand or

not as you choose (Fig. 157). Automatic work is somewhat slower, and most opticians having these machines use this attachment for polishing only.

The tools cost about two dollars per pair and the gages about

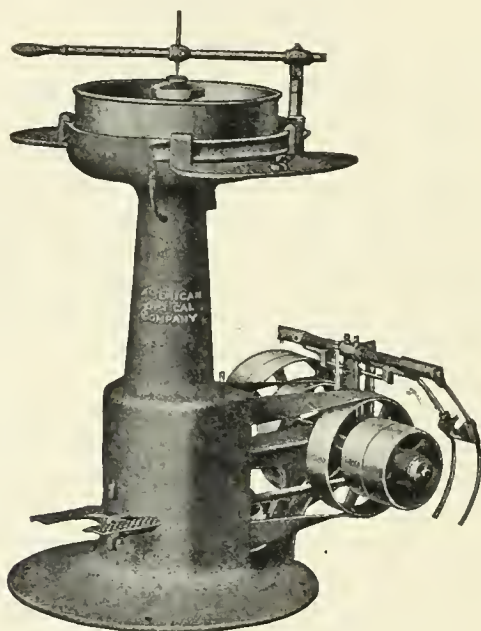

Fig. 155

seventy-five cents per pair. These are not supplied with the machine, so it is necessary to order whatever powers will be needed. It is well to have each .12 to 3 D., then .25 to 8 D., then .50 to 14 D., and each diopter to 20 D.; also a plano and an extra 6 D. for roughing torics. It is also necessary to have a pair of gages for each power.

Another point that must be considered is whether B. & L. or A. O. Co. glass will be used. If both, it will be necessary to have a set of tools for each, although by making an allowance it is possible to work very closely on one set of tools. There is about .03 D. difference on each diopter, and, as this is so small, it will come near enough up to 2 D., but above that select the nearest tool and polish it stronger or weaker as the case requires. (This will be explained later.)

The index of A. O. Co. glass is 1.507 and B. & L. 1.522. To obtain the required radius multiply the focus wanted in inches by the index of refraction, — 1. For example, 1 D. is 39.37 inches and the index of B. & L. glass is 1.522. We would then multiply 39.37 by .522, which would make the radius of the tool for 1 D. 20.55 inches. This does not enter into the work in any way, however, unless the optician is mechanically inclined and he desires to make his own tools. It is simply necessary, when ordering tools, to state what glass they are to be used for.

For grinding material the following grades of emery will be required: No. 60 for roughing, No. 100 for smoothing, No. 4-F for finishing and a grade of washed emery for fine finishing. The first three mentioned should be bought in ten-pound cans; the washed can only be obtained from optical concerns in five-



Fig. 156

pound cans. This is also very expensive, as compared with other grades, but it lasts a long time as it is necessary to use only a very small quantity at a time. It should also be remembered that a good finish saves a great deal of time in polishing.

There are several kinds of grinding material on the market,

such as carborundum, corundum, alundum and crushed steel, and these are graded about the same as emery. They cost more, but are supposed to cut faster and stay sharp longer, but for a single machine it hardly pays to mix the different materials. It should

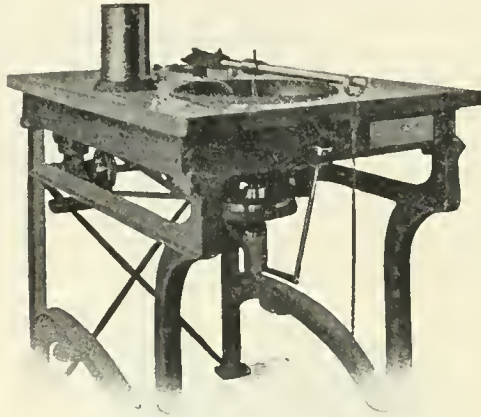

Fig. 157

be remembered that the sharper or rougher the materials used the harder it is on the tools and they must be watched more carefully to see that they are kept true. For polishing, rouge is used, and this comes in several grades. The grade used by jobbers is all right and should be ordered in five-pound boxes. There is also a black pigment used by some opticians. For polishing, cloth, felt or broadcloth is most commonly used, and, although this can be obtained almost everywhere, it is more satisfactory to order it from the jobber and you will then be sure of getting a quality that will do satisfactory work. Pitch can be obtained in one-pound cans from the jobbers, and this is used to stick the lenses on to the blocks. It can be made easily by taking a quantity of resin and melting it. When it is poured off to cool, a little turpentine should be added to soften it, or, in other words, to keep it from getting brittle. In the winter it should be softer than in the summer, as the temperature will affect it. If it is too soft the glass will slide on the block in polishing, and if too hard it will jump off the block when chilled in water. To make it black a little lampblack can be added. The dark surface makes it much easier to inspect the lenses when polishing.

A few blocks are usually furnished with a machine, but more will be required. Those furnished are round and flat (Fig. 158), and these will do for weak power lenses. For stronger powers deeper holes are needed, so they are made with a lug on the back (Fig. 159). Some of these should have a convex face (Fig. 160) and some concave for torics (Fig. 161). If square blocks are used it will be much easier to caliper the lens while grinding. A few small, round blocks will also be needed for wafers (Fig. 162).

Before fitting the tool to the machine it should be tried with the gage, and if it is not perfectly true it should be made so before attempting to grind the lens, otherwise the power will not be correct. A great many opticians use tools without gages, or, even if they do have them, they allow the tools to get all out of true and then send them to a machinist to be put in shape. This is entirely wrong and unnecessary, as it is a very easy matter to true the tool a little each time. The method is the same as trying the surface of a board to see if it is square; that is, the tool is held in one hand on a level with the eye and the gage is held perpendicular to the surface. If no light can be seen it will fit perfectly; if light is seen, notice whether it is weaker or stronger or if there is simply a high or low spot. In grinding, usually the tool wears on the side and the center will be high. For this work a piece of carborundum 8 in. long, 2 in. wide and 1 in. thick is used of a fairly coarse grade. The tool is placed on the spindle and run at full speed. With the carborundum stick it can be turned nearly as well as in a lathe. A little should be taken off at a time, however, and tried frequently with the gage.

There are usually two pans furnished with the machine; one of these should be used for grinding and the other for polishing. Some rough emery (No. 60) is placed in the pan with quite a lot of water, enough so that it covers the emery. It will do no harm if there is too much as the emery will stay at the bottom. In roughing, this is fed on to the tool with a spoon or with the fingers. The No. 100 emery should be placed in an agate drinking cup, or something of that nature, and wet so that it will be in the form of a paste. The No. 4-F emery can also be placed in a cup of this kind, but the washed should be kept in a small jar or box with a cover. The rouge can be placed

in a cup and wet in the same way. An extra cup of water should be kept at side of this, and, in polishing, this is applied with a brush. It will be necessary to have a large pail of water handy for rinsing the lens from time to time, and, after these different receptacles are arranged conveniently, you will be ready to grind.

For surface grinding it is necessary to have a stock of



Fig. 158

rough cylinders. These come in thickness varying from 2 to 10 mm. Those most commonly used are $2\frac{1}{2}$ and 4 mm. In selecting the stock for any particular job it is well to caliper them, as this not only saves glass, but also saves a great deal of time in roughing. For this work a pair of calipers graduated in $\frac{1}{5}$ mm. is

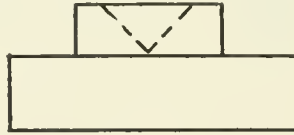

Fig. 159

used (Fig. 163). It is necessary to allow $\frac{2}{5}$ mm. for each diopter and $\frac{4}{5}$ mm. for each prism diopter. To this is added about $\frac{2}{5}$ mm. for grinding. For example, if we are to grind $+1 = +.50$, a $+.50$ cylinder is selected $\frac{4}{5}$ mm. thicker on the edge than the required thickness of the finished lens, thus

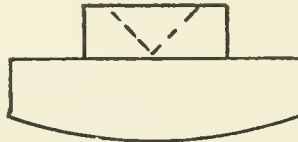

Fig. 160

allowing $\frac{2}{5}$ mm. for the curve and $\frac{2}{5}$ mm. for the grinding. When grinding a convex lens the center is hardly touched, providing the stock is about the right thickness at the start, but, unless the lens is fined down very carefully, which takes extra time, you cannot help grinding off a little extra glass, and, for this reason, a little allowance for grinding must be made. If

the combination to be ground were $-1 = -.50$, a rough cylinder having about the right thickness on the edge would be selected as practically the center only is ground. The allowance for grinding is all that would be taken off the edge. If the combination to be ground were $+1 = +.50$ axis $90 = 1^\circ$ in, it would be necessary to allow $4/5$ mm. more for the prisms. For example, the lens when finished should be 2 mm. thickness on the edge; to this is added $2/5$ mm. for the one diopter and $4/5$ mm. for the prism. To this is added $2/5$ for grinding and the rough cylinder to be selected would be $3\ 3/5$ mm. For this it would probably be necessary to use 4 mm. stock. It should be remem-

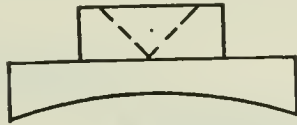

Fig. 161

bered that over 4 mm. rough cylinders cost extra for each millimeter thickness.

Toric rough cylinders should be purchased in molded form, when possible, as this saves a great deal of roughing. Most all blanks are made this way at the present time, but some of the smaller manufacturers put them out in flat form. There is also



Fig. 162

another point to be considered in using these lenses, and that is that often it is not possible to get the thickness out. In other words, when they are not molded, so much stock has to be ground out inside that it leaves the lens a knife edge. These can be obtained in plus and minus 6 D. base curve, also plus and minus 9 D. base curve. The majority of combinations can be ground on $+6$ D. base, but, as the spherical power increases, it reduces the toric effect so that it becomes necessary to transpose the combination, so that it is ground on a -6 D. base. It is preferable, however, to grind these combinations on a 9 D. base. For example, $+3 = +1$, if ground on a $+6$ D. base, would have but -3 inside curve. If ground on a $+9$ D. base curve it would be -6 D. on the inside. It could be transposed, however, and

ground on a -6 D. base curve and it would be -6 D. on the inside and $+10$ D. on the outside. It should be remembered that the base curve is always the weakest meridian on the cylinder side; that is, a $+6$ D. base curve is $+6$ in one meridian and stronger in the other. The difference will be the power of the cylinder. A -6 D. base is -6 D. in one meridian and stronger in the other. The spherical power is obtained by grinding the opposite side.

Another point to keep in mind is that concave toric cylinders cost more than convex, and, whenever possible, all combinations should be transposed so that a plus cylinder can be used. For

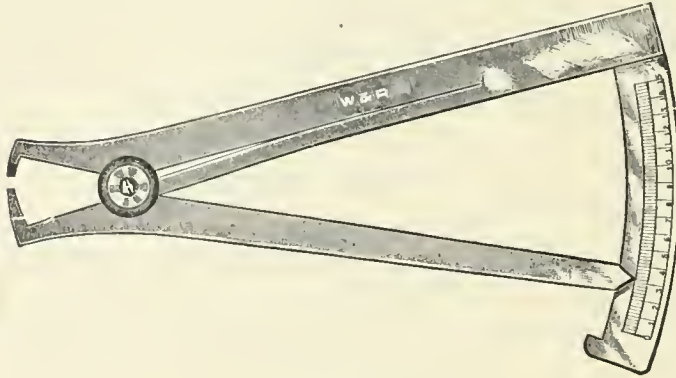

Fig. 163

example, in the combination $-1 = -.50$, if it is ground as written a $-.50$ toric cylinder would be selected and the cylinder surface would, of course, be on the inside. On the outside would then be ground $+5$, thus making the -1 sphere. If this were transposed to $-1.50 = +.50$, a $+.50$ toric cylinder would be selected and -7.50 ground on the inside to produce the -1.50 sphere. The reason that concave toric cylinders cost more is that the large factories have not as yet perfected machines for grinding these in quantity the same as the convex, and, consequently, they are ground singly at a greater expense.

When selecting colored lenses it is necessary to have in mind that as the glass is ground thinner the shade will be much lighter, and it is a very difficult matter to judge just how they are coming out. For this reason colored lenses with power are al-

ways expensive as a great many times it is necessary to grind two or three pairs before the exact shade is produced. The demand for colored lenses, however, is so unimportant that they call for little consideration as compared with the colorless variety.

For wafers, spherical lenses are used, but always selected so that one surface is correct. For this Pcx. lens always work in nicely as the old curves can always be found. For example, for the combination $-1 = +3.50$, a $+2.25$ Pcx. would be selected, and this would be on the outside $+3.50$ and on the inside -1.25 . We would then block it with the convex surface down and regrind the inner to -1 , at the same time reducing the thickness to whatever is desired.

Spherical prisms can be ground on rough prisms or a stronger plano prism can be used to get the thickness required.

CHAPTER XIII

SURFACE GRINDING—Continued

The machine now being in operation, and the emery arranged conveniently, the first operation will be to mark the lens. If a brown pitch is used in blocking, black ink will show well enough, but if black pitch is used, white ink is much better. If a simple compound is to be ground, no marks are required, but with all prism combinations the axis must be marked. This method is the same as for cutting, except that it must be taken into consideration that when the lens is on the block, you, perhaps, are looking at it from the wrong side. This, of course, depends on the combination. For example, if the combination to be ground is $- 50$ axis $45 = 1^\circ$ in, the lens can be marked with the cylinder in (or up, as it is laid on the protractor) just as it is to be fitted to the spectacle.

It is, of course, necessary to mark all lenses on the cylinder side, otherwise the marks will be ground off. When this is stuck on the block the cylinder will be down, and you are really working on it as though the axis was 135° . On the other hand, if the combination is $+ 50$ axis $45 = 1^\circ$ in, it would be necessary to mark it as if it were to be 135° . The reason for this is that you are marking it on the cylinder side, and after this is completed, it is to be fitted to the spectacle with this side out. The reason for marking is to have a line to grind the prism on, in other words, to tell the direction of the base. If this is to be in, the axis must be set at the proper angle so that the prism line must be horizontal. It does not matter, however, how this is placed on the block as long as the relative position of the axis to the base is correct.

If a double prism is to be ground, that is, a lens with the prism out and up, etc., it will be necessary to have a line for both prisms. In marking, the axis is first dotted and laid on the protractor at the proper angle, the prism lines are then drawn and the bases marked with the letter "B". As the prism lines are the only ones that are considered, the axis dots can then be rubbed

out if preferred to save confusion. There is a chart published for calculating the effect of double prisms that is very convenient, but it is not absolutely necessary to use this in surface grinding. A double prism is really a single prism ground at a different angle. For example, a 2° up = 2° out in the right eye would be practically a 3° axis 135° .

For blocking, an ordinary cheap gas stove is sufficient, but a piece of sheet iron should be laid over the top to prevent any pitch running down into the stove and clogging the holes. The blocks should be heated on the stove, and, when good and hot, should be taken off and placed on the bench. A little pitch should then be put on and allowed to melt. The glass to be blocked should be warmed slightly and laid on the block a second and then removed. It will be noticed that some of the pitch sticks to the surface. A little more of the pitch should then be put on the block and the lens laid on a second time, and then removed. In this way you gradually build up a backing for the lens. This operation should be repeated several times until there is pitch enough between the block and the lens so that it will hold securely, and also that there is no danger of the glass touching the iron. This not only prevents scratching, but if there is not pitch enough to form a good bed for the glass, it will crack when pressure is applied in grinding.

Flat lenses do not require as much pitch as those having a concave surface or a toric. Ordinary concave lenses can be blocked on flat blocks, but care must be used to fill up the space with pitch for the reason just stated. For convex toric cylinders, a block having a concave surface should be used, and although the curve should be about the same, it is not absolutely necessary, as the surface can be built up with pitch. For concave toric cylinders, convex blocks should, of course, be used. After the lenses are blocked, they should be allowed to cool gradually. After they are cool, the pitch on the back of the lens that overhangs the block should be scraped off with a knife so that the four sides can be measured with the calipers. Lenses can also be blocked over an ordinary Bunsen burner, and if it is done in this way, the pitch should be moulded into sticks and melted on the block the same as sealing wax is used.

We will suppose that the combination to be ground is + 1

= + 50 cyl. and $1\frac{1}{2}$ strap on the edge when finished. We have selected a + 50 cylinder, $2\frac{1}{2}$ mm. thickness, and have blocked it as described. We then select the tool to grind + 1 sph. This, of course, will be a concave tool to grind a convex surface. It should be tried with the gage to see if it is correct. The rough emery is already in the pan, with plenty of water. The block or lens is then taken in the left hand and held on the tool, spooning the emery on with the right hand. After the sharp edges are ground off, the block can then be placed under the spindle in the handle. It will then be necessary to adjust this so the lens is in the center of the tool. As to position, the grinder can stand wherever it is most natural. Some of the older machines are arranged so that the handle points directly to the operator, and some use it in this position; others stand a little to one side. In either case this is somewhat awkward and the best way is to have the handle run from right to left, so that it is in a horizontal position to the grinder.

The newest machines are made so that they can be adjusted to any position. When the handle has been adjusted correctly, the machine can be started. The lens will then revolve or spin on the spindle, and the grinder then moves the handle forward and back so that the lens will travel from the center to the edge of the tool. This motion is to break up the rings which would form on the surface of the glass if it were held in one position. One must be careful, however, not to run over the center of the tool, or the block may fly off. As the lens is moved back and forth, the emery should be fed continually with the spoon. After the lens has ground a minute or two, it should be removed, and if it is ground all over the surface, it is ready to measure. Now take the calipers and measure all four edges. If it is the same all around, the lens is centered and not prismatic. If there is a difference, take the block in the hand the same as when starting and grind off a little of the thick edge, then measure again. If found correct, it can then be placed on the spindle again and ground as before.

The system of measuring should be remembered, that is, $\frac{2}{5}$ mm. allowance for every diopter. As we started with a lens $2\frac{1}{2}$ mm. thick and wish to obtain a lens $1\frac{1}{2}$ mm. it will be necessary to grind off 1 mm. or $\frac{5}{5}$ on the calipers. In the roughing

about $2/5$ mm. will be taken off, being careful, of course, to keep it centered as described. Do not be afraid to measure it too much, for it is better to take off a little at a time than to spoil the lens. After it has been roughed down, wipe off the tool and rinse the lens in water. (For this purpose, keep a pail at the side of the machine.) Now take the No. 100 emery, which is in the cup, and grind as before, smoothing the surface and taking off about $1/5$ mm. Then wipe off the tool again, rinse the lens and take the No. 4-F emery. This you can apply with the fingers, or a brush if preferred. After this grade, clean the lens and tool again thoroughly and you are ready for the fine finishing. For this operation it is necessary to use but very little of the finest emery, applying it with one finger. The idea now is to get just as fine a surface as possible to obtain next to a polish.

Although it is unnecessary to waste the emery, all scratches and pits must be removed, as time is not only wasted in trying to polish them out, but the lens produced is not so good. It should also be remembered that this grade of emery is expensive. All through these different operations keep in mind that the lens must be calipered frequently to keep it from being prismatic, and also, that as you are continually grinding off glass, you are nearing the thickness required for the finished lens. Also be particular to clean the tool and the lens between each grade of emery used, as one grain of rough emery on the tool when fine finishing will scratch the surface.

If the combination was $- 1 = - 50$, the operation would have been the same, using, of course, the opposite tool, but if the order called for a certain thickness in the center, the lens would be $2/5$ mm. thicker on the edge. Although this has to be taken into consideration in convex combinations, allowing the lens to be $2/5$ mm. thinner on the edge than on the center, it does not make quite so much difference, for the reason that the concave lens is apt to be ground through the center. This will be noted in grinding the stronger combinations, and one must be accurate in measuring when selecting rough cylinders.

For each prism diopter $4/5$ mm. must be allowed, so if the combination to be ground was $+ 1 = + 50$ axis $90^\circ = 1^\circ$ in, we would allow $2/5$ mm. for the sph. and $4/5$ mm. for the prism, making $1 1/5$ mm. besides the allowance for grinding.

We have already described the method of marking for a prism, and the blocking is the same as for a compound. In starting to grind, the lens is held in the hand, not on the spindle, as before, but we grind off the edge where the apex is to be, leaving the edge for the base as thick as possible. It will now be seen why it was necessary to mark a mechanical axis or prism line. It should be measured on this line, and the base should be $4/5$ mm. thicker than the apex. The two opposite sides are of no account, except that they should be exactly the same thickness. If one was thicker than the other, there would then be a prism power up or down as well. By this it will be seen how to grind a double prism. For example, if the combination was to be $+ 1 = + 50$, axis $90^\circ = 1^\circ$ in and 1° up, we would have $4/5$ mm. difference on the edge between the apex and base on the 180° line, and also $4/5$ mm. difference on the 90° line. When the lens has been roughed down in the hand so that the prism power is approximately correct, it can be placed on the spindle and roughed down to the proper thickness. It should be remembered that all the prism power must be roughed on with the block in the hand, and that the lens cannot be ground prismatic on the spindle. This does not mean that the lens will not grind prismatic because it will grind off center more or less, but it means that you cannot control the direction of the prism power on the spindle. As different grades of emery are used, the edge must be measured constantly, and if there is any variation found, take the lens in the hand again and true it up with whatever grade of emery you may be using.

In grinding a cylinder prism, the plane tool is used, and the prism power only has to be considered. For example, a $+ 50$ axis $45 = 1$ in would be marked and blocked as usual, and the apex ground to the proper thickness, say 2 mm. The base should then be $2 \ 4/5$ mm. thickness. The plane tool should be kept as accurate as possible for the reason that the slightest spherical power can readily be detected on the axis of a plano cylinder. This is also a difficult lens to polish, as will be explained. It should be remembered that a plano lens is the most difficult to grind.

In grinding the wafers, it is only necessary to grind them small enough to be thin. The spherical lens is blocked, putting

the surface that is correct down on the block, of course, and grind it down to about 30 mm. diameter. For horseshoe-shaped wafers they can be ground smaller, but if less than 25 mm. they will be too thin to handle.

Torics are ground the same as a regular compound, obtaining the rough toric cylinders from the jobbers. If the combination to be ground is $+ 1 = 50$, a $+ 50$ toric rough cylinder is selected, and this will have the cylinder on the outside. This is blocked with the surface down, and $- 5$ ground on the inside. It should be remembered that these should be blocked on concave blocks so that the surface will fit.

If any amount of roughing is to be done, do it on the extra tool kept for this purpose. This should be about 6 D. curve, and it is not necessary to keep it accurate. The idea is simply to have a tool with strong power to save the regular tools. Rough emery grinds the tool very quickly, and, consequently, throws it out of true. Quite a little time must then be spent to keep them in shape.

CHAPTER XIV

SURFACE GRINDING—Continued

Toric and Special Lenses

Toric lenses are ground in the same way as compounds; that is, the spherical side. The rough toric cylinders are obtained from the jobbers in the moulded form, and this reduces the labor considerably. When it was necessary to grind them from the flat form a great deal of roughing had to be done. The blocking has already been described, and, if this is properly done, there is very little danger of breaking. In grinding torics it is very difficult to get the spherical power accurate for the reason that in grinding strong curves a little variation can hardly be detected, but when the curve is ground on the opposite side the total power of the lens is so weak as compared to the surfaces ground, that it is a very easy matter to grind the power .12 D. weaker or stronger. For this reason torics should be ordered of reliable houses that give this matter proper attention. One should also be particular to notice whether B. & L. or A. O. Co. rough toric cylinders are used. If an A. O. Co. plano-cylinder is to be ground on a B. & L. tool it should be 6.18 to be exact. (6.12 will be near enough.) If a B. & L. plano-cylinder is to be ground on an A. O. Co. tool, it should be 5.82 (5.87 will answer).

If a $+ 1 = + 50$ is to be ground, a $+ 50$ toric cylinder with $+ 6$ D. base curve is selected, and $- 5$ D. spherical ground on the inside. For $+ 2 = + 50$, a $- 4$ D. spherical would be ground on the inside, and so on. As the spherical power increases, the inside curve decreases, so that if the full toric effect is desired it will be necessary to transpose the combination and grind it on a concave cylinder.

If a $- 1 = - 50$ is to be ground, a $- 50$ cylinder with $- 6$ D. curve is selected, and $+ 5$ sph. ground on the outside. Remember that the base is always 6 D., and, to produce the required spherical, simply deduct the power desired, and this will be the curve to grind. Also do not forget that when grinding a $+$ and $+$ combination on a $-$ cylinder that the combination must

be transposed. This is the cause of many mistakes. For example: $+ 1 = + 50$ if ground on a $+$ cylinder will have a $- 5$ inside curve, or 1 D. weaker than the base. When transposed it will be $+ 1.50 = - 50$, and the outside curve will be $+ 7.50$, or 1.50 D. stronger than the base. When 9 D. base curve is required plus cylinders can most always be used, and it is rarely

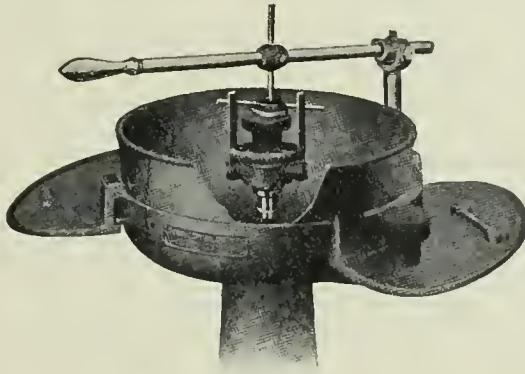

Fig. 164

necessary to use minus. The curves are not only extreme, but the rough concave cylinders are expensive.

Toric cylinders are usually ground on automatic machines, although a hand attachment for the regular surface machines can be obtained (Fig. 164). This work at present is not attempted by opticians, except in large shops or in localities where it requires some time to obtain the rough stock. As the sale of fused bifocals increase, however, more opticians will be obliged to grind cylinder or toric surfaces if they give prompt service to their customers. The hand attachment requires special blocks, having an iron rod running through the center (Fig. 165), to keep the axis of the lens in line with the tool. If the cylinder is fairly strong it will save time and also the wear on the tools to rough a spherical power on the glass first. It is then placed on the cylinder tool and the cylinder power put on with 3-F carborundum. This material cuts faster than emery and leaves a smooth surface. The machine can be run at almost any speed, but for the beginners it is better to use about 600 revolutions

per minute. It is operated by the hand lever, the same as when grinding a spherical, but it is necessary to stop the machine to feed it. Care must also be used to keep the lens on the tool, as a slip is apt to not only spoil the lens, but the arms of the machine can also be broken very easily. After the carborundum, No. 4-F emery can be used and then the washed emery. The operations are the same as when grinding sphericals, except that it requires a great deal more time. For those that can afford it, the automatic machines are to be preferred, but they usually require much more time. There is a new machine just placed on the market, however, that will grind a pair of lenses quicker than a pair of sphericals can be ground by hand (Fig. 166). This will be of great benefit to the trade generally, as time is the most important part of the business to-day, except, of course, accuracy.

Another machine that is used quite extensively is the "Hercules" (Fig. 167). This machine does not require a separate spindle, but fits the spindle of any hand surface grinder. It does not revolve, but the spindle simply drives the lens-moving mechanism.

Prescription houses are frequently asked if certain combinations, especially prisms, can be made in torics. All combinations of lenses can be ground in toric form, but sometimes no

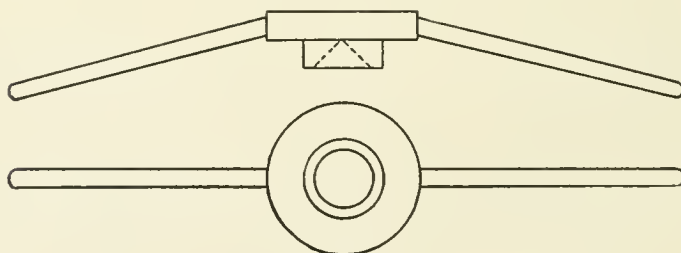

Fig. 165

better results are obtained. For example, $-12 = -1$ would be an extreme curve if ground in toric form, as the inside curve would be -19 D. It would be much better to make it in double concave form with -6 spherical on one side and $-6 = -7$ on the other. If this form was not desired, it would be better to make it in the regular compound form.

It is also a common idea that strong concave combinations are thinner when ground in toric form. This is entirely wrong, and the only way to grind these is to make them lenticular. A lenticular lens is one having the power in the center only, usually in a circle, having a diameter of 22 mm. This is the stock form, but they can be ground with the circle as large as the width of the lens. The larger the circle, the thicker the lens, however. Outside the circle is usually plano, but when a large circle is desired, the outside can be ground convex. This reduces the thickness on the edge, so that it may be as thin as desired. This style of lens can also be made with an oval center, but these are quite difficult, and it is best to order them from the prescription houses. Lenticular lenses are very desirable and should be used more, and the reason that they are not is that opticians are not generally familiar with the different forms, or else they believe that the field is limited.

In grinding lenses this style the first operation is to grind the power in the center, the same as any regular lens. This may be ground away out to the edge if desired. It is perhaps, just as well to do this when the power is not strong, but in the higher power lenses it requires too thick stock and it also makes unnecessary work. After the focus is ground and polished the center should be filled with sealing wax and then the plano tool and grind off until the circle is the correct size. This should not be over 25 mm., unless the focus is not over 10 D. If higher than this, it makes a better lens to grind it convex. The power of the outside curve will depend on the size of the circle desired, also the focus of the lens. The curve required will vary from 6 D. upward, and, until you are experienced, it is a good plan to select a low power and try it. If the curve is not steep enough, try a stronger one. The outside surface should be polished before the wax is removed. In referring to the outside curve of this style lens we mean the curve outside the circle and not on the opposite side of the lens.

Fused bifocals are very interesting to grind, and as the blanks can now be obtained, the most difficult part has already been done. In ordering the blanks, it is necessary to give the full prescription, so that the proper blank can be selected. It must be remembered that the curve ground on the disk side will change the addition, so this must be taken into account.

It is also impossible to grind a cylinder on the disk side for this reason so in compounds an allowance for the spherical must be made. In making the blanks, a depression is ground in the base lens of a certain power, the curve having been calculated for the index of the flint to be used for the disk. For example: If a 10 D. will produce 2.50 D. addition, each diopter will add $+ .25$. If the blank was intended for a plano surface and a $+ 1$ was ground on it, it would increase the reading addition $.25$ D. By this it will be seen that if the prescription called for distance

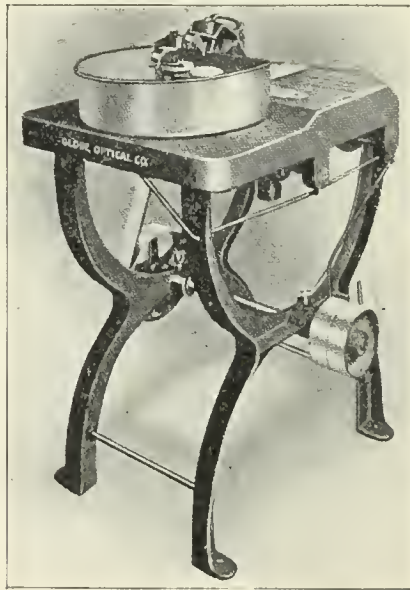

Fig. 166

$+ 1 = - 50$ axis 90, reading $+ 3.50$, and the blank used was intended for a plano surface, the lens when finished would have for reading $+ 3.75$. The blanks are blocked the same as any lens, but care must be used in heating.

If the lens was not properly annealed it is very liable to break. The disk side is always ground first, as this must be brought down to the proper size. This is the most particular part of the work, as it can be easily ground too small. After the flint is ground off so that the surface is even it should be fined

down very slowly, as this glass is very soft and grinds away quickly. In grinding a pair, always grind both disk surfaces first, so that the disks can be made the same size. Frequently, one lens will be ground so that the disk is the correct size, and then the other will have a scratch or imperfection in it, so that it must be ground smaller. It will then be necessary to reduce the other to match. In this way, grinding first one and then the other, it is possible to get them to match. After the disk side is ground, the other side can be brought down so as to make the finished lenses the proper thickness. If a cylinder is to be ground on the other side, it will be necessary to mark the axis, as the disk must be in the proper position. If the lens is twisted to correct the axis after the lens is finished the disk will be out of center. If the axis is found to be off, it must be blocked again and reground.

When the lens is laid out for axis, always try the tool with lens measure and see if the axis is in the proper position. There is nothing difficult in grinding these lenses, but grind slowly, taking off a little at a time. In polishing, remember that the flint is soft and is easily made wavy.

When the lens is ground and the finish is as near perfect as possible, the lens is ready to polish. The tool should be cleaned and the lens rinsed in water. Then take a piece of felt, either round or square, as you prefer, and stick it on the tool. The material used is called "Tacky," and this is made from powdered rosin, or pitch, the same as used for blocking, and cut with alcohol, so that it is in the form of a paste. This is first applied to the surface of the tool with a brush, while it is running. The machine is then stopped and the felt pressed down firmly. Then start the machine and with a knife trim off the corners near the edge of the tool. This is where the art of polishing a lens, weak or strong, comes in. A convex lens may be polished strong by cutting the cloth large, and weak, by cutting the cloth small. A concave will be just the opposite, the lens will be strong when polished on a small cloth and weak on a large cloth.

The rouge should be placed in a cup and mixed with water, so that it will be in the form of a paste; then place aside of this another cup containing plain water. Now apply the rouge with a brush, so that the felt will be well saturated; then place the

lens on the spindle and start the machine. As the lens revolves, move the lever forward and back, the same as when grinding to break up the rings that would form if it were held in one position. Apply the rouge occasionally, but do not let it get too dry, so that it will cake on the cloth. If it has this appearance, apply a little water. A lens will polish faster with a fairly dry cloth, but it cannot be too dry, of course. After polishing for two or three minutes, take the lens off the spindle and examine the surface. For this purpose a gas flame will give better results, as it has more or less flare. Daylight will answer, but electric light

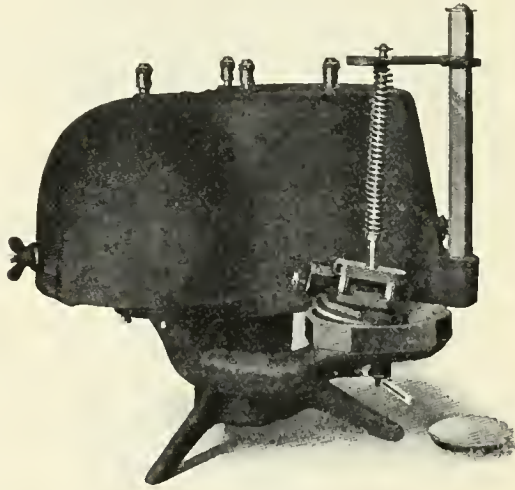

Fig. 167

is not very good. The lens should be held in the hand, a little below the level of the eyes, in such a position that a good reflection of the flame will be found on the surface of the glass. By tilting it gradually so that the reflection moves across the surface, it will show up any imperfections, such as pits or scratches. When the glass has but a slight polish, the emery marks will be seen and these must be polished out.

After the first inspection, and the lens has been found free from large pits and scratches, replace it on the spindle and polish a few minutes longer and then inspect again. As soon as the emery marks have all disappeared the lens is polished. If for any reason a scratch appears, or a pit of any size is found, it is

best to finish it again with the washed emery, as this will not only save time, but a better lens will be produced. When a lens is polished too long, the power is apt to be off, so that the quicker it is polished the better. Remember, however, that it will take just about so much time to polish a lens, and that just putting a glaze on the surface is not a polish. Beginners are very liable to make this mistake, and it requires quite a little practice to judge the surface of a lens. The cloth can be used several times, and, in fact, until it wears down too thin. When polishing a plano surface, such as a cylinder prism, never use a new cloth, but always use one that has been used before. The nap on a new one will sometimes produce aberration.

To remove a lens from the block, place it under a running faucet for several minutes. If the pitch is then started a little with a knife, the glass will come off easily. The lens should then be placed in a basin of turpentine to eat off the pitch.

CHAPTER XV

SOLDERING AND REPAIRING—THE EQUIPMENT

Soldering is a part of mechanical optics not attempted by many opticians. While it is not very profitable, perhaps, it must be done occasionally to satisfy a customer. It also frequently happens that it must be done in a hurry, as there is no time to send it away. There are many jobs that opticians are called upon to do in the way of small repairs and one thing that is necessary is to have proper equipment and the work then will not be difficult.

Gas is very essential to do good soldering, although it can be done with an alcohol lamp. Alcohol is very unsatisfactory, for the reason that it is impossible to obtain a large flame and, therefore, there is not heat enough.

There are several ways of arranging the gas, and possibly the simplest is to use an ordinary swinging gas bracket and remove the lava tip. The size of the flame can then be regulated and an ordinary blowpipe used (Fig. 168). There are two styles,



Fig. 168—Blowpipe

one having a bulb, forming a sort of reservoir for air. Either will do, however. There are also a number of different styles of blowpipes that are used principally by dentists. Some styles are quite elaborate, having valves to regulate the air and also the gas. These are not necessary, however, as one can be made very easily that would be simpler and better. It consists of a brass pipe with a rubber tube, which is attached to the gas at any convenient place, and another tube is inserted at an angle of 45° . On this is another rubber tube, which is held in the mouth. An ordinary pipe mouthpiece can be used if desired to hold in the mouth. The drawing (Fig. 169) gives a good idea of the construction. A blowpipe of this kind can be held in the hand in any position and is, therefore, much more convenient.

There are many styles of soldering blocks, such as charcoal, asbestos and numberless patented ones. Webster's soldering block (Fig. 170) is the best and this, with a charcoal block, is all that is necessary. A borax slate (Fig. 171) will be needed and this

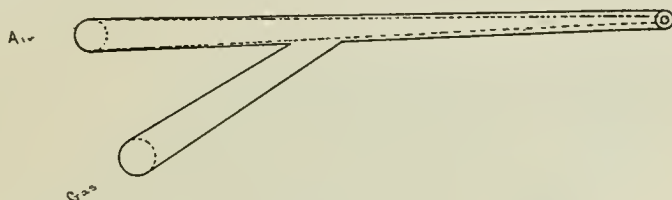

Fig. 169

is a slate having a concavity in which borax and water is mixed. The borax is prepared in tinfoil and can be used in the wrapper, so that it does not soil the fingers. In using put a few drops of water on the slate and rub the borax around a few times until the water looks milky. It is then applied with a small camel's hair brush. Two jars will be required, one containing a solution of

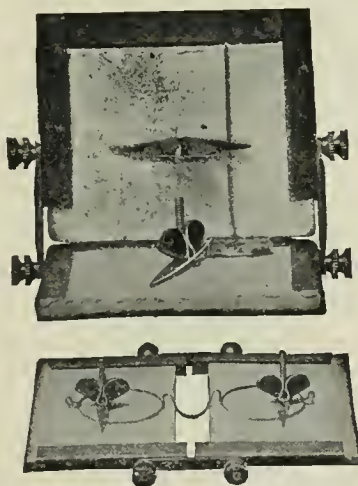

Fig. 170—Webster's soldering block

one part sulphuric acid and two parts water. After the metal is heated in soldering it is blackened and if dipped in the acid, while hot, this is removed. It is then rinsed in plain water.

These few articles are all that is required for the soldering, with the exception of solder. This can be obtained in several

forms. The most common is silver, or hard solder. It is sold in flat strips, which can be cut with scissors into small bits, or it can be had all cut as small as desired.

Although silver solder will answer all purposes a great many use gold solder. This can be obtained in all karats and is usually

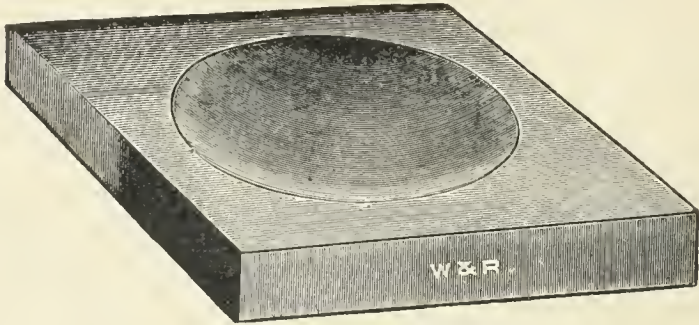

Fig. 171—Borax slate

claimed to be "easy flowing." A spool of soft solder is handy to have around, but it should never be used in repairing spectacles.

For tools one will need all the ordinary pliers, such as flat, round and snipe-nose; also the hollow-chop and cutting pliers. It



Fig. 172—Spectacle and eyeglass stake

will also be necessary to have two or three pairs of tweezers; one should be a good pair for picking up screws, etc., but the others can be cheap ones. The latter should have a slide so that they can be used to hold articles while soldering. As it is necessary to blow the flame on the points, it draws the temper so that they are of no use for any other purpose. A pin vise should be added

for holding wire, etc. This is especially handy when filing down wire for rivets and things of that kind. A small vise should be screwed to the bench and a small anvil that stands on the bench will be found very convenient. A good assortment of screw-drivers should be selected; a good, substantial one with a wood handle and two or three others with different size blades and with swivel tops. A spectacle and eyeglass stake (Fig. 172) is very good to hold the endpieces of frames when extracting old screws. This is made with a wood base to stand on the bench, or it can be had for a vise. There are also a number of screw extractors on the market, but one of the spring punches fitted with a screw extractor is all right (Fig. 173). A couple of small hammers will be needed, and have one with a brass head. This will not mar or dent some of the softer metals as easily as steel.

A good assortment of files is required—rat tail in one or

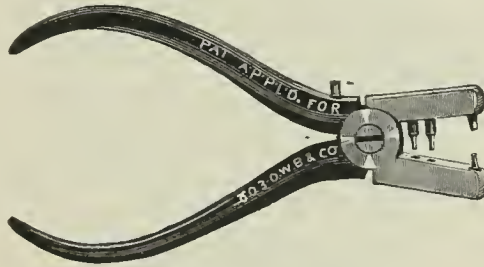

Fig. 173

two sizes; a flat one four or five inches long and five-eighths of an inch wide; a three and a half or four-inch half round; a square file, not too large; also a screw head file. For the cut, do not have them too coarse. If you have a good assortment have them range from Nos. 2 to 6; No. 4, however, is about the medium cut. It is well to have all these fitted with handles, as better work can be done. These can be obtained in assorted sizes for about five cents each. A burnisher is a good tool to have, but not too large a one.

Buff sticks will be needed; also crocus and emery sticks. For buffing the ordinary felt stick is all right, but for smoothing and finishing for the buffing a leather stick is required. These can be bought with a kind of rawhide, quite thick; the stick is also very long. This should be cut down so that it is fairly

thin; *i. e.*, both the stick and the leather. This will give it a little spring and also allow it to be used in small places, such as under the shank of the bridge. The material used with this is Tripoli; or pulverized pumice, mixed with oil, will answer. There is, however, on the market now a prepared form of Tripoli called "Cut Quick." This is in more convenient form.

These sticks are used mostly, however, if one has no power. With power, wheels can be obtained to do most of this work



Fig. 174

much easier. There are certain jobs, however, where these sticks will be found very convenient. A buff head should be large enough to be substantial, so that it will run true; also that the bearings will not wear quickly. If it is too light, the shaft will spring easily also. Another point is that, if the bearings are not good, it cannot be run at a very high speed without rattling,

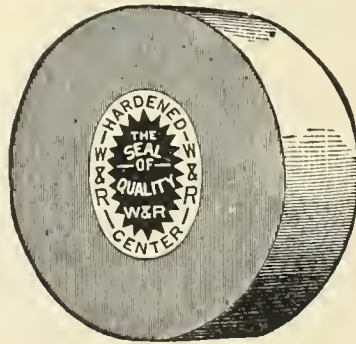

Fig. 175

and this is, of course, very objectionable. It should be run at a speed of from two to three thousand and, for all kinds of work, with the exception of finishing the ends of screws in frameless work, it should run towards you. This is a point that some workmen do not understand. They have outfits with one buff

head and this is, of course, fitted to run toward you for buffing, etc. Now a screw finisher must run left-handed, or from you, because if it did not it would turn the screw out instead of rounding it. On the other hand, if we run the spindle the other way, or from you, the screw finisher will be running the right way, but the taper will be threaded the wrong way, so that the wheels will turn off instead of tightening.

It is also the same with the chuck and nut. These will loosen so that nothing will stay in them. The only way to overcome this is to have a separate head for the screw finisher. If one does not have power these heads can be run very successfully

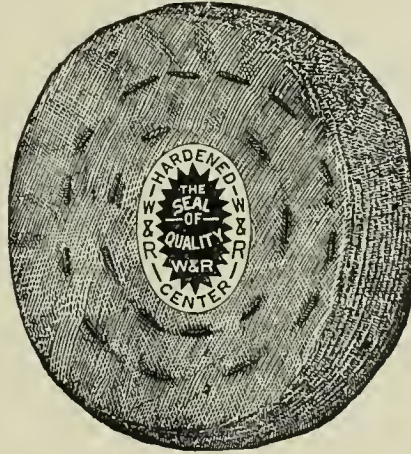

Fig. 176

by foot power. The foot wheel is better than the treadle, as more power and speed can be obtained. There are outfits all complete, however, with a zinc-lined box and treadle all belted if desired. By purchasing an ordinary buff head and screwing to a bench, then placing the foot wheel beneath, is very satisfactory.

For wheels, get a number of stiff brushes (Fig. 174), having one each of one, two, three and four rows. These are used for cutting, as well as cleaning. Then a felt buff wheel from three to four inches diameter (Fig. 175), a cotton wheel about three inches diameter and also a rag wheel six to eight inches diameter (Fig. 176). Rag wheels come thin, so three to four will be re-

quired. These should be placed together, with cardboard washers on either side, about two inches diameter, in place on the buff next the chuck and screw the nut up tightly. With this kind of a wheel better results can be obtained in fine polishing, such as putting on the final finish on a frame. Care must be used in polishing on this wheel, however, as temples and such things catch very easily if not held right. (This work will be explained in the next article.)

For other small articles we would suggest a hand or jeweler's brush; a roll of binding wire—*i. e.*, soft iron wire, very small, for holding parts together while soldering; a stick of polishing rouge—get the kind wrapped up in tin foils so that you need not get any more on the fingers than possible; a solder burr for burring out the eye wire after soldering; a temple burr for end pieces; a bottle of soldering fluid.

The completeness of the outfit depends, however, on what extent you intend to go into repairing. Years ago it was necessary to be fitted to do anything, from a simple solder to making a frame complete, but to-day it is entirely different, the goods cost less, are made better and a greater assortment of bridges can be kept in stock. Consequently, when an old frame is brought in for repairs it is often cheaper to give them a new one, or a new part, rather than attempt to repair it.

CHAPTER XVI

SOLDERING AND REPAIRING—Continued

Now as to the first step in preparing the break to be soldered. We will take, for instance, a break in the eye wire. First take a fine file, a half-round is the best, as it is pointed and fairly thin. It should be very fine; No. 6 is the best. With this file lightly over both sides, or, in other words, the parts to be exposed to the flame. Then place it on the soldering block and secure it with the clamps, so the ends just come together. Now mix the borax in the slate, first putting a few drops of water in the bottom, and then rub the borax around a few times, until you have obtained a milky fluid. Then, with a camel's hair brush place a little on the parts to be soldered and apply a small piece of solder on one side of the break and you are ready to apply the heat. Turn on the gas so the flame will be about two inches high.

If you are using the ordinary gas bracket, the tip having been removed, swing it directly in front of you and hold the blow-pipe in the right hand. The soldering block hold in the left, at the side of the flame. Now place the blowpipe side of the flame close to the outlet and blow a small, steady blue flame at the break (Fig. 177). This flame should be like a needle point, holding the work so the point that touches the frame will be about $\frac{1}{8}$ inch in thickness. Heat the part on which the solder is placed, and as soon as the solder begins to flow throw the heat on the opposite side of the break, thus drawing the solder with the heat.

If the work is held in the hands, the borax is placed on both sides and the solder on one side, as before. Apply the heat to the side on which the solder is placed, separating the parts until the solder is ready to flow. As soon as the solder starts to flow, dip both end of the break in the borax and apply the heat on the opposite side, as stated above.

The cause of melting is blowing too much heat, either with too large a flame or blowing too long. Remember that it requires but a very small point of flame and little heat, but

properly placed. If a blowpipe is used as described in the preceding article, it will be found much more convenient, as it can be held in any position. The soldering block can be held in the left hand, or laid on the bench, and the blowpipe in the right and the flame directed as desired. As soon as the solder flows and the eye wire seems to be connected, blow the flame all over the eye wire adjacent to the break for a second, to warm it, and then plunge it into the acid, and rinse in plain water. This will remove all the black and leave the frame in good condition.

If for any reason the parts did not unite, it will be necessary to start all over from the beginning. Do not attempt to add more

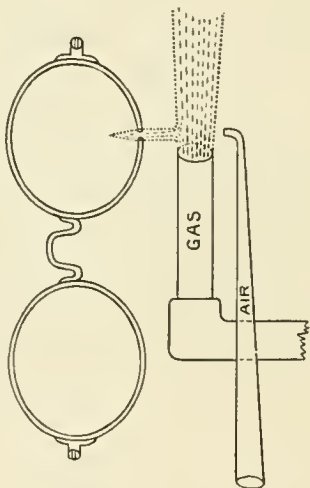

Fig. 177

solder and keep blowing at it, for this may cause the frame to melt. File the parts again, put on more borax and start again.

After the eye wire is soldered satisfactorily it will be necessary to file the break a little to smooth it, using, of course, the fine, or No. 6, cut. Then take the leather stick, referred to in the preceding article, and with tripoli, pumice and oil or Cut Quick, which is the prepared cutting material, go over the parts until all traces of file marks are removed. If power is used, the brush is the proper wheel and the cutting material is rubbed on by holding the stick against the wheel. Then with a solder burr, especially constructed for eye wire, burr out the inside of the

eye wire. This little tool is used in the buff head and run at a fairly high speed, say about 2000 revolutions per minute.

You are now ready to polish. For this work use the cotton buff and this, of course, runs toward you. Rub plenty of the stick rouge into it while it is running. Now hold the frame tightly in both hands, with the eyes perpendicular, and the eye that has been soldered downward. In this manner there is no way for the frame to catch, provided you keep your mind on it. You will soon learn to protect the parts that are liable to catch with the hands, such as the end pieces and bridge. In all repairing it is best to remove the temples, as they are very liable to get in the way of the flame or catch in the wheel when buffing. After the frame is polished in good shape it should be washed with hot water and soap to remove all the dirt and rouge that collects in the joints. When replacing the lens it will be necessary to reduce it a little, as the eye is always made a little smaller when soldered.

Most all solder jobs can be done without a soldering block if one is experienced, but quite a little practice is required. In this way the parts are held together with soft iron wire, called binding wire.

Bridges can be obtained all ready to solder to the frame; that is, they are bent and grooved for the eye wire. The most common method to-day, however, is to use what is called unbent bridges. These consist of the bridge stock in assorted lengths, tapered about one the right size and thickness for the shank. In using this stock the principal feature lies in judging the length required. The medium sizes require $2\frac{1}{8}$ to $2\frac{1}{4}$ inches. First bend the crest or arch; this can be done over the handle of a tool or any round piece of wood. It is better to do it in this way than to attempt it with the hollow chop or periscopic pliers, as these dent the stock and must be taken out afterward. In gold filled this is impossible, as the gold will be finished too thin. After the arch is formed, bend up the shanks. These may possibly be too long and should be cut off, allowing stock enough, of course, for the feet. A frameless bridge can be soldered on straight, and if preferred the frame can be made this way also. This style, when made at the factory, however, has a depression pressed in the eye wire to make a blind joint. In repair work this is not attempted.

The bending of the feet can best be done in a vise, as the stock must be turned edgewise, this being quite difficult. After the feet are bent they should be grooved with a float file; that is, one with rounded edges, just the right size for the eye wire. You are now ready to solder it to the frame. First prepare the eye wire by filing it lightly, the same as for any solder. It can then be placed on the soldering block, clamped in and the solder placed on the top of the foot of the bridge (Fig. 178). This operation can be done better in the hand, however. The eye wire can be held by the joint in the left hand, and the bridge in a pair of tweezers in the right hand. By having a slide on the tweezers, as before described, it is much easier. If the blowpipe is arranged so that it can stand on the bench, both hands will be free to work with.

Another method is to use binding wire to hold the parts in position. In soldering the procedure is the same as before, placing the borax and solder on the parts and heating them and as soon as the solder begins to flow, throw the heat in the direction you wish the solder to flow. Just enough solder must be used so that it will flow freely in the groove in the bridge, but it is unnecessary to have so much that it will flow outside all over the joint. Care must also be used to see that the bridge is in the center of the eye wire. When one eye is soldered, the other can be put on the same way. The frame can then be lined up and the bridge bent to dimensions.

At this point it is well to see that the crest is the desired angle. If not, it can be formed with a pair of crest-angling pliers. If one does not have this tool the angle must be made first, while the stock is straight. For all saddle bridges, except the lowest ones, such as no height, the natural bend of the stock produces about 45° . "C" bridges, however, must be bent first. This operation is done by tilting the stock edgewise a little. This can be done by holding both ends of the stock securely with pliers and bending it over the edge of the bench pin. After the dimensions are made right any superfluous solder can be filed off with a fine file and finished with the buff stick and Cut Quick.

With power this can be done much better and quicker. For this work use the brush wheel, putting on plenty of the cutting material. This wheel reaches in under the shank and smooths

up the foot very nicely. After smoothing up in good shape it can be polished in the regular way, being very careful, however, to hold the frame tightly, so that the shank will not catch in wheel.

One of the most common breaks is in the shank, at the turn. Formerly this was considered an unsatisfactory job, as, in order to make it strong, quite a little solder must be left in the turn. This was objectionable and yet, if finished in good shape, it made a very weak joint, as considerable strain comes at this point. Now this is a very common job, however, but the practice

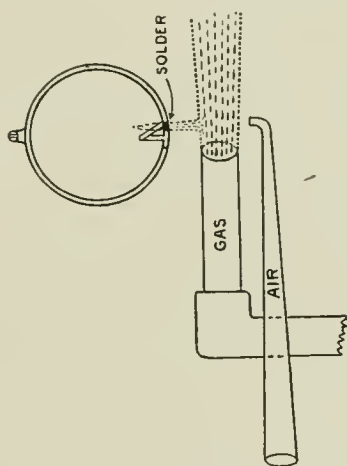

Fig. 178

generally is to leave plenty of solder; in fact, sometimes it is pretty well filled up. For this operation it is best to use binding wire, so as to bring the parts together in the right position. The parts must be prepared in the same manner as before prescribed and proceed in the same manner.

First prepare the eye wire by filing, then groove out the end piece, unless possibly it has just pulled out. Most breaks of this kind, however, are next to the end piece, so that a part of the eye wire is in the joint. When doing a job of this kind, be sure and remove the temple and screw and separate the joints. Do not, under any circumstances, attempt to solder an end piece on the eye wire, having them screwed together, for if you do you will find both end pieces soldered together and it will be like one mass, and it can never be taken apart. For this operation the

end piece can be bound to the eye wire with binding wire, and in this case wind it around the eye wire several times, quite a little distance back from the joint, and insert the other end through the screw hole and place it on the end of the eye wire. Do not attempt to bind it so that the eye wire comes near the solder. A simple way to do this work is to hold the frame in one hand and hold the joint on an old file, by inserting it in the screw hole. Do not use much solder in this operation, as it requires but the smallest piece to hold it securely. After the joint is soldered it will be necessary to burr out the eye wire and possibly reduce the lens a trifle.

This material is worked the same as gold, except that one must bear in mind that there is only a very thin coating of gold over the base metal. One stroke of the file will cut through it, consequently the work must be done in such a manner that no filing is necessary. The great feature in handling gold filled is to use the smallest amount of solder possible. In this way it flows only into the break or between the joints. At the factory this work is usually covered with a coating of boracic acid to prevent discoloring. This is a powder and by wetting the frame and placing it in the powder enough will stick to it. The polishing should be done as quickly as possible, as the metal will not stand too much.

Temples are very unsatisfactory to repair and only in cases of emergency should it be attempted. They are made in gold by drawing, and in gold filled by swedging. This process gives them the temper and spring. As soon as heat is applied to them they are annealed, and consequently are very soft. The best way to repair them is to use a ferrule. These are small pieces of tubing just the right size to slip over the broken ends, and as the base metal is solder it is only necessary to apply the heat and a good joint is obtained. This method leaves a bunch on the temple, but it is fairly strong.

Spring stock must have considerable temper and spring, consequently when heat is applied they are practically useless. When one is broken near the end, or screw hole, a new hole can be punched, and although it makes it somewhat shorter it is very satisfactory. This is the only way any kind of a spring can be repaired, but even this method hardly pays, as springs can be obtained at a very low price.

CHAPTER XVII

SOLDERING AND REPAIRING—Continued

Steel goods are fast disappearing, although the better class of trade still call for them occasionally, preferring to wear them instead of gold. It seldom, if ever, pays to repair them, unless possibly it is to solder on an end piece. Steel is handled in much the same manner as gold, except, of course, silver solder is always used. The parts to be soldered are first filed bright, so that all traces of rust or foreign substances are removed. The parts are then dipped in borax and the heat and solder applied as described in the preceding article. This metal must be heated to a greater temperature; in other words, red hot. It is then plunged in the acid and this removes the black and also restores the temper to a certain extent. In finishing, the surplus solder is filed away and smoothed. The frame then should be rubbed with fine emery cloth to leave the steel bright. If it is to be nicked, no more finishing is required. If the finish is bronze or blue it must be refinished to match as near as possible the old finish.

At the factory the process is simplified by using hot sand. This produces an even color of any shade desired. For small shops it is hardly practical to attempt this method, as it is so seldom used. The easiest way is to use an alcohol lamp (gas will not answer, as the regular flame will blacken the work and a Bunsen burner has too much pressure). When using the ordinary jewelers' alcohol lamp the wick should be pressed down so that a very small flame is obtained. The frame is then held in the left hand and the lamp in the right. Take the work to a place where good daylight can be obtained, as artificial light will not answer and neither will poor daylight produce satisfactory results. Now apply the flame directly to the metal (Fig. 179) and then remove it quickly so that it is heated but a very little. Repeat the operation several times, being careful to heat the frame but a second at a time. The color will be observed after the flame is removed and it will be noticed that it changes considerably in a second or two. Bronze will appear first, then blue, and, if you are not careful, you will burn it and bright spots will appear. As soon as each spot is the desired color move the flame

along. This is one of the most difficult jobs in repairing, and, to produce an even color, it requires considerable practice. If the color gets too deep refinish the frame with emery cloth and try again.

We are frequently called upon to cut a frame to fit old lenses. In this work all four end pieces, if it is a spectacle, must be moved. This requires four solders, so it is easily seen why this work is expensive. If one end piece on each side is moved the frame will be out of shape. Take one end piece at a time, blow the heat on to remove it, then refinish it and set it back on the eye wire slightly. The end that overlaps can then be filed off square. There are lens washers now on the market which are

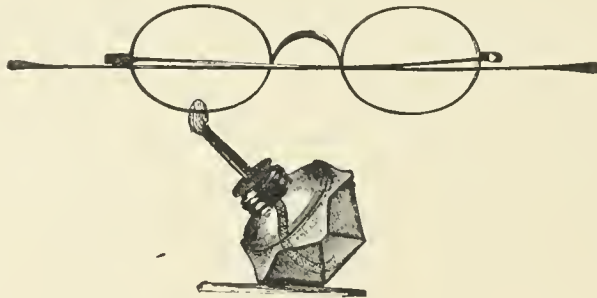
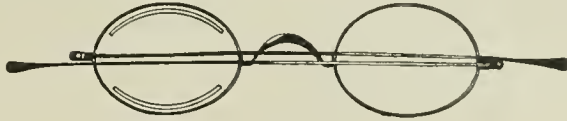

Fig. 179

used extensively for this purpose and these are very satisfactory (Fig. 180). If they are not at hand, tinfoils, or, better still, tea lead, can be inserted in the eye wire to fill the open space. If the lens is only a very little loose, the end pieces can be filed slightly, but this method reduces the thickness so that it weakens the joints considerably. It is always preferable to fit new lenses if possible and this can frequently be done without the customer's knowledge.

Screws for all standard frames can be obtained cheaply so that it is well to have a good supply on hand. If one has taps for these threads they can be used to replace odd makes by simply tapping new threads (Fig. 181). The great difficulty is in removing the old screw, however. For most jobs the screw extractor, referred to on page 157, will suffice. This can be used for end-piece screws if the head is not too far gone. If

the head has been turned off completely it will probably be necessary to drill it out. Small twist drills, such as can be purchased in any hardware store, are used for this purpose. After the screw is drilled out the hole must be tapped and the new screw inserted. If the ends protrude they should be filed

**Fig. 180**

off carefully and the end piece polished. Stud screws, or screws that project, can frequently be removed successfully by filing a slot in the head with a screw head file. By then placing the frame in a stake (Chapter X) or against a solid square surface (if a stud screw hold it with a pair of stud or round-nose pliers) and by using a wooden handle screwdriver it can be turned gradually.

Fingerpiece mountings are used so extensively at the present time that it is well to be prepared to fit these while the customer waits. The factories will possibly replace these without charge, but it seems absurd to require a customer to go without their glasses for from one to three days when these can be inserted in a few moments. These springs can be obtained from the

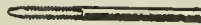
**Fig. 181**

jobbers in gold filled for seventy-five cents a dozen pair and in gold for a dollar and a half. They come in rights and lefts and with two, three and four coils. The best mountings have four coils, as this produces an easier pressure and less liable to break. They are placed on the screw with the top ends over the inside edge of the straps, the coil being wound from left to right on the right side and from right to left on the left side (Fig. 182.) The lower end is turned under the guard. After both ends are bent so they are secure they can be cut off fairly close, as will be readily seen.

There is another fingerpiece mounting that works on a

principle different from the coil or spiral spring mountings. The spring of this mounting, instead of being attached to the bridge, is attached on the arm of the guard (Fig. 183) and near the guard. If it is desired to increase or decrease the tension of the spring on this mounting the entire guard, including the spring, may be removed and the arm or lever of the spring (not the arm of the guard) may be curved slightly or straightened. Curving the lever toward B increases the tension and straightening toward A decreases the tension.

In case the arms of the guards are broken on any style of fingerpiece mounting it is far better to replace them with an entirely new guard, as soldering is always unsatisfactory and is far from neat in appearance.

It is frequently necessary to fit new zylonite to guards, al-

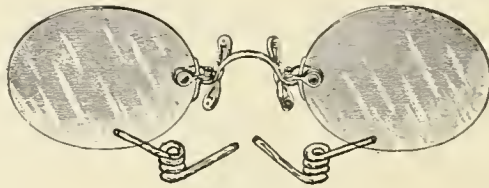

Fig. 182—Illustration showing position of right and left coil springs in their relation to the mounting

though it hardly pays, except on gold. There are a great many styles where the zylonite is peculiar in shape, and at the factories these are punched out with dies. When one is called upon to furnish one of the irregular shape the best that can be done is to cut it with shears or a knife as near as possible. This material can be smoothed and shaped with a file so that it is possible to do a very good job. Zylonite can be obtained in any form, such as plain sheets, plain strips or in pieces ready to be fitted. The corrugations are pressed in at the factories, so it can be obtained in this form if preferred. It is well to have a small assortment, however, so that all sizes can be obtained. Small wire, or even common pins, are used to secure it to the guard, but rivets, made especially for this purpose, should be kept on hand. The guard is already punched and small holes should be made in the zylonite just large enough to force the pins through. These are driven through from the back and are then cut off quite close and with a

light hammer riveted gently. If the holes are just the right size it requires but a few taps. If plain zylonite is used, it will be necessary to corrugate it with a screw head file, making the cuts as small and as regular as possible. Scraps of shell can also be used for this purpose.

Corks have to be fitted quite frequently, although many times, if they are only soiled, they can be washed with soap and water. This is the method employed when guards are slightly soiled from lying in stock. If they are quite bad and not worn down they can be sandpapered to look as good as new. For this pur-

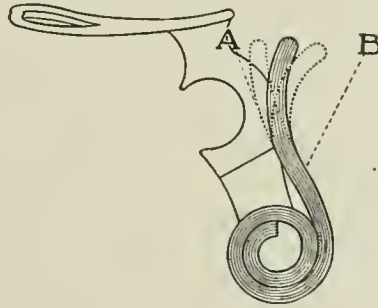

Fig. 183



Fig. 184

pose No. 00 sandpaper is used, any grade coarser than that will rough them. Cork can be obtained in the rough, cut the right size, or it can be had all rounded and finished with groove, ready to fit into the guard. The difference in price is so slight that it is better to use the finished. The old cork should be removed and the edges of the guard lifted with a burnisher or a knife just enough so that the cork will slide into the guard easily. The edges can then be burnished down so that it will hold securely. The end can then be trimmed off and if the guard is then too thick it can be sandpapered down. Some styles, such as No. 0 Anchor (Fig. 184), have a round disk which must be riveted and for any of these styles the disks can be ordered, cut to shape. The regular styles of guards in nickel and gold filled are low-priced, so that it is often cheaper to fit new ones than the charge made to cover the cost.

Dowels, or rivets, as they are more generally called, have

to be fitted to spectacle end pieces. In gold filled they loosen and fall out easily. In gold they wear so that the temples are loose and must be replaced. The only satisfactory way to tighten old gold temples is to fit new dowels, but for quick repairs spec washers can be obtained. Two, three, or as many as are necessary, are placed on the dowel to fill up the space in the joint and the end piece screwed together. Dowels can be obtained in the different sizes ready for use. They are tapered and left long so that they will fit any joint. When fitting these, it is only necessary to drive out the old one and insert the new. Place the joint on an anvil or vise so that the small end of the dowel can be driven into a hole and with a light hammer tap it lightly a few times and then try the temple. If it is not fairly tight, drive it in a little farther. If it is still loose drive it out again and with a small broach ream out the hole a little. The dowel can then be inserted and driven in slightly. Do not have the temple fit too snug but see that it works fairly stiff. If it works too freely it may be too loose after the ends of the dowel are finished off and it will then be necessary to do the work all over again. When the dowel is in place the ends should be cut off closely and finished first with a fine file and then polished on the buff wheel. If the finished dowels are not available, steel wire can be used, a size a little larger than the hole should be selected and a piece about a half an inch long cut off. This should be placed in a pin vise and filed to a slight taper.

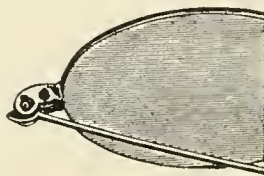

Fig. 185

It can be done on the bench pin, revolving it with the left hand and filing with the right. In gold filled the dowels are usually rounded on the ends and for this metal the finished dowels for the particular grade that you are using should be kept in stock. A regular dowel can be used, however, and the ends rounded with a screw finisher. As gold filled is a softer metal the temples are

fitted more loosely and the joint brought together tightly. This may not seem practical, but it is the only way the dowels can be made to hold in the end pieces. If they are fitted the same as gold the temple will work them loose. In some grades of gold filled the flush dowel is used and the largest end is punched slightly with a very small punch (Fig. 185). This is supposed to spread the head slightly to hold it in place.

There are a number of small jobs that one is called upon to do that are interesting if time is of no account, such as drawing out gold temples, or balling them. To ball a gold temple it is only necessary to file the end slightly, to clean it and then dip it in the borax and apply the heat. This is very convenient when it is necessary to shorten temples. Gold filled cannot be done in this manner but requires a gold ball soldered on the end. This is a little more difficult and is not attempted unless necessary.

The fitting of lorgnette springs is now quite common and this is a job that requires quite a little ingenuity. The springs can be obtained quite reasonable and if one has the time and cared to experiment with them a little practice will enable them to do as good a job as can be done at the factory. When fitting the center springs to plated styles it is necessary to have them replated. Platers when doing this work often use acid, which destroys the spring, so they should be cautioned regarding this point. The older styles, such as heirlooms, are very difficult to repair and should not be attempted.

INSPECTING A PRESCRIPTION (THE LENSES)

The inspection of a completed prescription calls for more than a mere glance and, even though scrutinized carefully, there is much more to be done. After the workman in a large shop has mounted a spectacle or eyeglass he does not attempt to straighten or "true it up," but it is passed along to a truer or inspector. If the shop is large enough for a truer, the work will pass through his hands, and his part is to straighten and line up, or, in other words, put the glasses in shape. It is then passed along to the inspectors, whose part of the work is to see that the prescription is filled correctly and to put on the finishing touches. Even though the truer may be an expert workman, it is perhaps im-

possible for him to allow each job the necessary time and, consequently, a temple must be curved a little more or some other little point must receive the attention of the inspector. In many of the large shops this work is done entirely by the inspectors, and with this method the best results are always obtained.

An inspector must necessarily be an expert; he must not only be familiar with mounting in all its branches, but he must have a thorough knowledge of lenses. To this must be added a good education to thoroughly understand the different prescriptions. The reading of a prescription intelligently often requires quite a

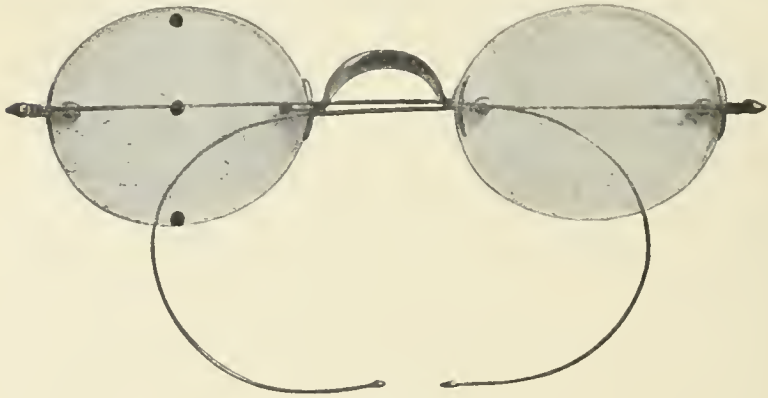

Fig. 186

little study; in the first place, the writing is not always legible, and then again, two different meanings can often be interpreted. The work of inspecting should be carried through systematically, for the reason that if the time is spent truing up the mounting and then a lens is found to be incorrect, the work was done for nothing. Each time a lens is fitted the mounting is thrown out of adjustment, even if only a very little.

The first step is to neutralize the lenses: this should be done with a spherical test case. Cylinders should never be used, as they are more awkward and necessitate the lining up of the lenses first. With sphericals the spectacle can be held at the proper angle, or as near as possible, and the lens neutralized in this direction. It can then be turned at right angles and the opposite meridian tested. If preferred, the first test lens can be held in

position and another spherical lens, with the same focus as the cylinder calls for, held over it. The better way, however, is to use one for the spherical, then remove it, and place one in position for the other meridian, having the combined strength of the spherical and the cylinder.

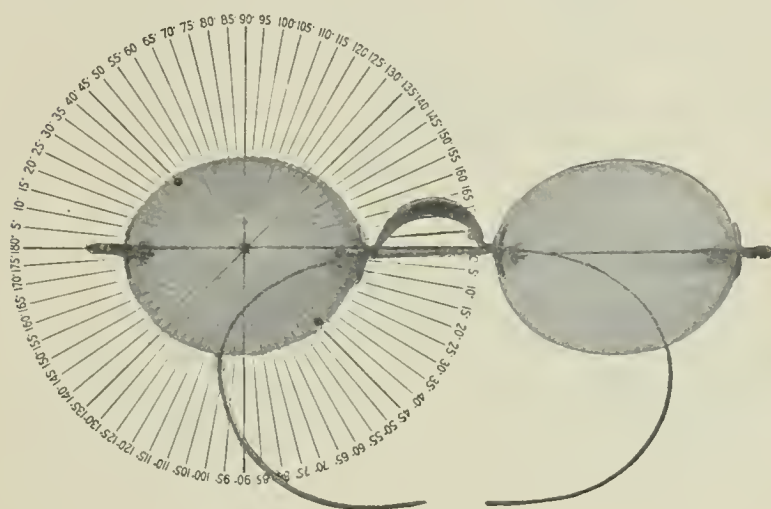

Fig. 187

For example, the lens to be neutralized is $+1 \text{ C} + 50 \text{ ax. } 90^\circ$. First take a -1 spherical and test the vertical meridian; then remove this and select a -1.50 to neutralize the opposite meridian. In this operation no attention is given to the axis, except that the glasses should be held so that the axis is approximately perpendicular. The lens measure is used by many for this work, and if it is to be relied on, must be watched constantly, to see that it does not get out of adjustment. With constant use the three points gradually wear, so that new points need to be put on occasionally. This work must be done at the factory, but, by testing it at intervals on a plane prism and adjusting the center pin it can be kept in condition.

The next step is to locate the axis and mark it. This should be done on a machine if possible, but if one does not have one, a straight line drawn on a card will answer for medium and strong-power lenses, and one on the wall, at a distance, for the weak power. (For instruction in this work see Chapter III,

"Marking Lenses." This explains the breaking of the line and the drawings show how the axis can be located.) Three dots are then placed on the lens, one being the center (Fig. 186). The

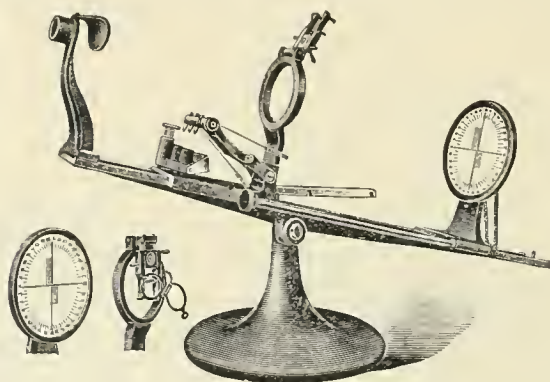

Fig. 188

spectacles are then laid on an axis chart (Fig. 187), with the glass screws on the 180° line, and the two dots on the extreme edge will locate the axis.

A machine for this purpose is the Standard centering ma-

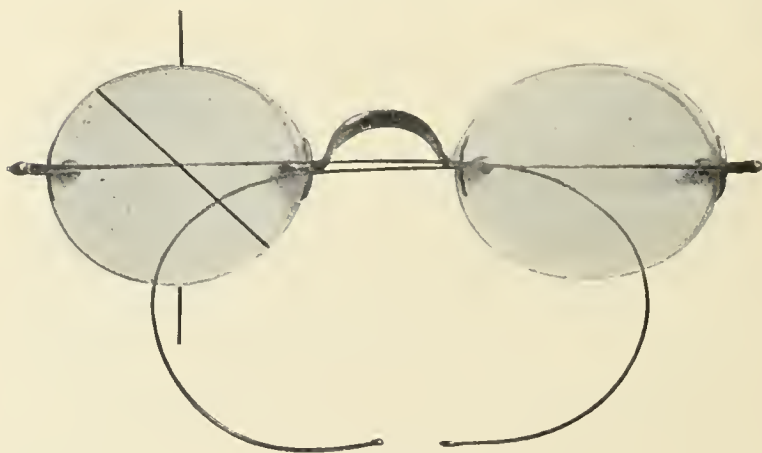
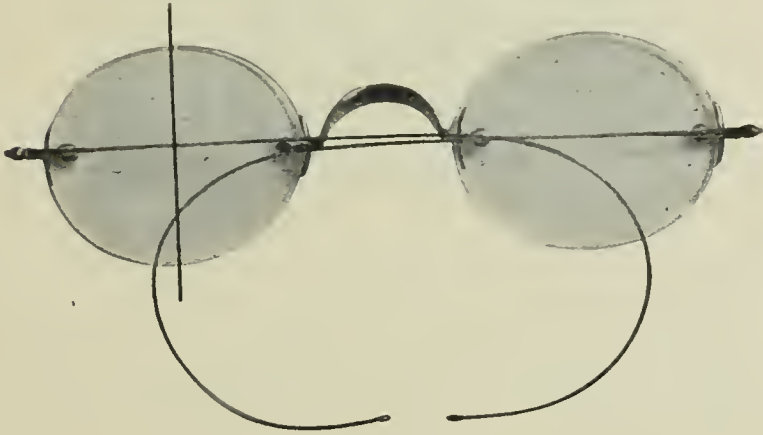

Fig. 189

chine (Fig. 188). This is equipped with a holding device in which the spectacles are placed. An axis dial on the back can be operated so that it will revolve. When the spectacles are placed

in position the line will appear broken (Fig. 189); the dial is then revolved until the lines are continuous (Fig. 190). The axis is then read from the dial. For example, if the lens was axis 45° and the machine happened to be set at 90° , the lines would appear as in Fig. 189. The advantage of a machine over the method of holding the glasses by hand is that the spectacles are held rigidly and the axis is read quickly from the dial; it is unnecessary to dot the lenses and then place them on an axis chart. There has been a machine in use by a well-known retail house where the axis can be located electrically. It is known as the Lloyd axo-

**Fig. 190**

nometer (Fig. 191) and is now on the market. With this machine the axis can be located both quickly and accurately.

The axis having been located, the next step is to inspect the size and shape of the lenses. If it is a repair job, the new lens must match the old lens on the opposite side. The size is measured for length and width with a rule, and this should be read in millimeters. If the prescription calls for a pair of oo eye lenses the measurements will be 40 mm. long by 31 mm. wide. Although it is perhaps necessary to measure both lenses, an experienced eye will readily detect a difference in size of the two lenses. This can be noticed as the shape of the two are compared. If the

lenses are ground in an automatic machine they must, of course, be alike, but when ground by hand it is a very easy matter to get one different from the other. This is especially true in repair jobs, where a new lens is ground to match an old one. It is

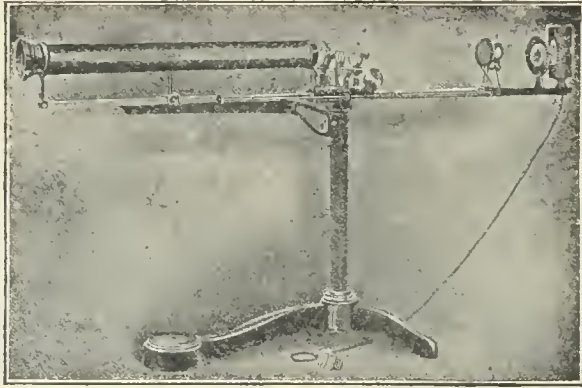

Fig. 191

possible to grind two lenses exactly the same measurements and still have a decidedly different oval (Fig. 192). This part of the work is where the expert inspector counts, and many jobs are rejected for this reason. With a little practice the shape can readily be compared and at the same time the difference in the size will be noted.

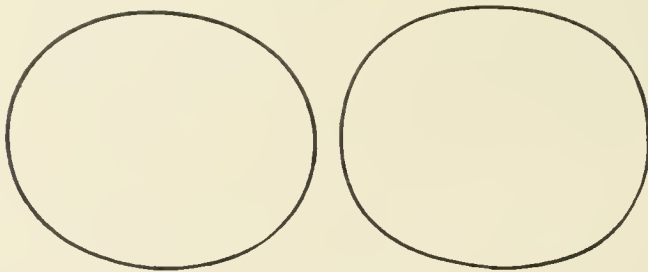

Fig. 192

The lenses having been found to be the correct size and shape, the inspector then notices if the bevel on the edge is about right. If too little bevel has been placed on the edges, they will

chip easily, therefore the job must be returned to the grinder. For this operation it will be necessary to take the lenses out, and they, of course, must be remounted. Here it will be noted that if the spectacle had been trued up the time was wasted, and must be done over again. If the bevel is too deep, or an attempt to take out a chip has been made, thereby leaving the bevel uneven, a new lens must be ground. A lens that has been beveled too much will spoil the appearance of any pair of glasses, as this gives the lens the appearance of having a white edge. A good illustration of this is a pair of bevel edge or frame lenses mounted up as a frameless spectacle.

When inspecting the bevel the edges must be watched carefully for chips. These are often minute, but when exposed to an electric light will sometimes sparkle like a diamond. In grinding lenses by machine, the edges should come out perfectly clear and as sharp as a knife edge, provided the grindstone is in good condition. Many stones are neglected, however, and with constant grinding over one part of the surface slight ridges will appear at the edges, and if these are not turned out the lenses will chip the least bit, perhaps not enough so they cannot be taken out in beveling. A workman, in handling quantities of lenses, is very apt to overlook some of these and, when located in the finished job, the lenses must be taken out of the mountings and the chips run out. Occasionally a chip on the top or bottom of the lens can be taken out without removing the lenses from the mounting, but care must be used not to strike the metal on the stone. A long, quick sweep of the lens is required; do not attempt a short one, as this will give the lens an irregular appearance. Make it as long as possible and, of course, not very deep.

If one has plenty of time the surface can be examined at this point for scratches, but as it necessitates cleaning the lens thoroughly the inspector usually waits until the mounting has been trued up. He can then wipe the lenses once and give the job the finishing touches. If he cleans the lenses at this point he will then soil them in the truing, and this makes an extra operation. This may seem trifling to many opticians, but every move counts when examining several hundred jobs in a large shop. If the truing has been done and a scratch found, a new lens will be required. You

may say that the truing must be done again; that is true, but the inspector takes this chance.

One may make the suggestion that all this may take considerable time and that the prescription house does not give them this attention. This is not so, as every job passes through this same rigid examination, but the operation to a trained eye requires a very few seconds. Practice will enable any optician to be very critical and many are expert in this work. The larger majority, however, we are afraid do not inspect their jobs at all, but depend entirely on the prescription houses. Although the best houses rarely make a mistake, it is by all means wrong to place a pair of glasses on a patient without giving them the proper inspection.

The lenses having been found to be correct, attention is then directed to the frame or mounting. If it is a rimless spectacle we first note the drilling to see that the holes are on a line and also that they are the correct distance from the edge. Should one or more of the holes be drilled a little above or below the

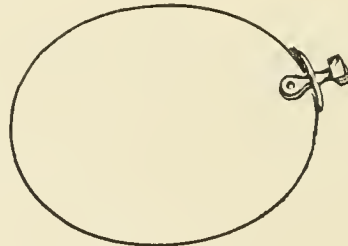

Fig. 193

line the strap will necessarily be fitted at an angle. It also gives the lens the appearance of being out of shape. If it has been drilled "off" but slightly the strap can be removed and the hole filed a little up or down, as the case may be (Fig. 193). This will naturally enlarge the hole to some extent, but the strap will remain fairly tight.

This remedy is resorted to in cases of emergency only. The most satisfactory way is to fit a new lens, and this is usually done in the large shops. If it is found that the hole has been drilled too near the edge the strap can be bent down slightly with a pair of No. 35 strap pliers. The correct method is to make a slight

kink near the post (Fig. 194) and under no circumstances should the points be bent down, leaving an opening between the lens and the strap (Fig. 195). This operation is explained fully in Chapter IX under the heading "Mounting."

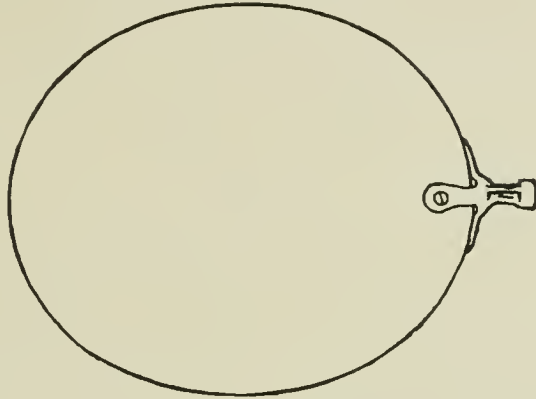

Fig. 194

At this point should also be noticed whether the strap has been fitted properly to the surface of the lens, as illustrated in the same article. If the strap has been bent to a wedge shape it

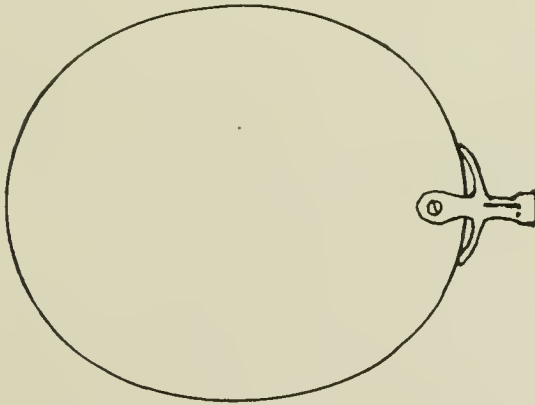

Fig. 195

will be possible to grasp each lens and twist the lens in the strap considerably. This not only throws the glasses out of alignment, but is very liable to cause the lenses to chip near the straps, as the lens-bearing parts slip back and forth on the edge. If the

straps are not correctly fitted in this respect they can easily be removed and fitted with the strap pliers. It is unnecessary to fit new lenses as the holes are not changed materially in this operation. When inspecting the drilling it is unnecessary to have the spectacles in perfect alignment, although it is perhaps easier to detect any variation in drilling. With practice one soon learns to judge each lens separately and even though the mounting may be all out of shape, it is a simple matter to tell if the straps are fitted correctly.

The next point is to inspect the frame or mounting and see if the material ordered has been used. Is it steel, gold or filled? In other words, is it what the prescription calls for? Mistakes are easily made in numbers, and you may find that gold-filled has been supplied when gold is called for, or *vice versa*. The difference in the metal can be distinguished by the trade-marks, but a trained eye will readily detect the difference by the appearance and style of the mounting. The temples, if a spectacle, should be measured for length; also as to whether regular or cable temples are wanted. Mistakes of this character are very frequent, and with so much detail to remember, it is a simple point to overlook.

If the prescription calls for eyeglasses it is more complicated, as the style and length of spring, the style of guards and the length of studs must be noted. With fingerpiece mountings this is simplified, as the style and number only requires attention. The size, being designated by the number, we soon learn to judge the correct mounting. The inspection of the mountings or frames from the optometrist's standpoint is about all that is required of an inspector. Frequently a pair of glasses will be returned with some trifling error in the guards, or something of that nature, and a letter calling attention to the inspector's carelessness. While it is true that mistakes of any kind should never occur, one would never refer to the carelessness of an inspector if he realized the detail in the inspection of a pair of glasses.

After inspecting the lenses and mountings and everything having been found to be correct, the glasses must now be put in condition to deliver or mail, as the case may be. The first operation will be to "line-up" the mounting; in other words, bring the straps into position, so that when the spectacle is held endwise

the heads of the screws will form a straight line. Then hold the spectacle so that you can look down on the edge and see if the lenses are straight in this respect (Fig. 196). If they are not, they will have to be brought into line by bending one shank up or down, as the case may be. For this operation the shank is held with a pair of flat pliers, either snipe nose, flat or parallel



Fig. 196

jaw. The No. 40 plier, which is used for adjusting fingerpiece mountings and for holding endpieces, on account of the narrow parallel jaw, is very convenient for this work also. The top of the bridge is grasped with the thumb and forefinger of the left hand and the shank of the bridge with the pliers in the right hand (Fig. 197). The bridge can then be thrown up or down with the left hand and the pliers in the right hand held stationary, or the bridge held securely with the left hand and the shank bent

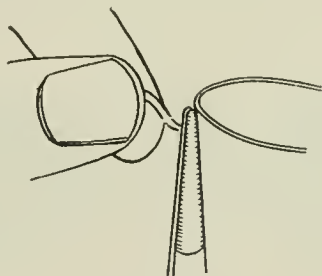

Fig. 197

with the pliers in the right. If judgment is used before changing the bridge, it is a very easy matter to learn which way to throw it, but to the inexperienced it may be found that although the spectacles have been straightened, the dimensions will not be correct. In this operation it will be seen that we either make the bridge higher and with more inset, or lower and more outset.

As we have just been working on the shanks of the bridge, it is just as well to inspect the height first. If it is too high or too low, bend it by the method just described, bending both shanks,

of course, the same amount. Next turn the glasses endwise and inspect the inset or outset. If the mounting has been properly selected and bent to measurements by the bender, the raising and lowering of the bridge to correct height should also place the crest in the proper position as to the inset or outset. If these are not found to be correct it must be changed at this point.

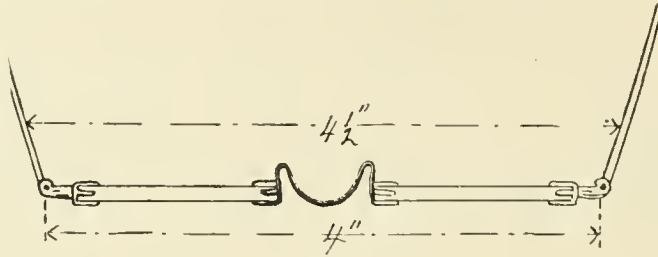

Fig. 198

At this time it is well to measure the pupillary distance and also the base of bridge, as if we find it necessary to change one measurement a variation at some other point may be of assistance in some way. For example, if the pupillary distance is too great and the base of the bridge is also wide, it will, perhaps, be only



Fig. 199

necessary to bend the crest of the bridge, so as to make the base narrower, and this will also change the pupillary distance the required amount. If the base is too narrow the operation will be *vice versa*. By this it will be seen that in the inspection of a

prescription the bridge having been bent to the required dimensions before mounting, the work calls for slight changes only. Each variation is so slight that one helps the other, provided, however, that the bridge has been properly selected and bent correctly. When selecting a bridge for a prescription and bend-

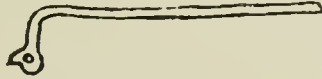

Fig. 200

ing it to measurements, it requires more skill, whereas the slight changes that are necessary in inspecting can be accomplished easily by anyone having had a little practice.

The bridge, having been straightened and bent to dimensions, we turn our attention to the endpieces and temples. First, see that the temples set back the right amount; also that they are even, and one not set back more than the other. The prescription will probably give the distance between the temples; this distance is measured one inch from the endpieces. Some opticians make

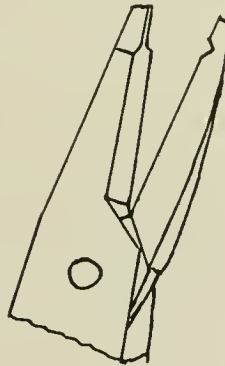

Fig. 201

the mistake by measuring a frame between the temples at the endpieces, but this is not correct. The distance at the endpieces can be four inches and at a point one inch from the endpieces it can be $4\frac{1}{2}$ inches (Fig. 198).

Temples can be set back almost any amount, except that in extreme cases, for very full faces, it is necessary to use extension

temples, or long endpieces. There is a question, perhaps, which looks the best, but although the long endpieces (Fig. 199) may look the best off the face, the extension temples (Fig. 200) are very much neater on the face. The long endpieces extend out so far that they are very conspicuous, whereas the extension curving around the temples of the patient, look very neat.

Extension temples can be obtained from the prescription houses, or they can be bent very easily with pliers. Always select a length one-half inch longer than required, as the bend will take up about that amount of stock. In setting back the temples the tips can be filed in steel and gold, but in gold-filled it is better to use a pair of No. 42 endpiece pliers to hold the joint (Fig. 201). The joint is held by the plier in the right hand and the temple

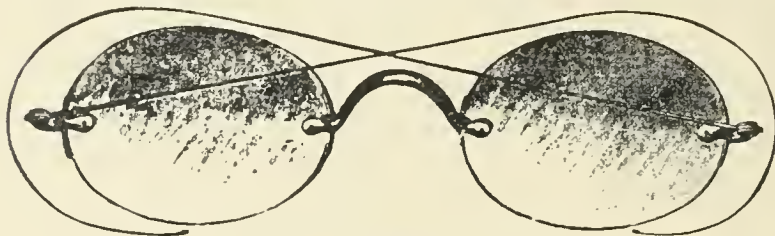

Fig. 202

grasped with the thumb and forefinger of the left, as close to the joint as possible. The temple is then bent backward to the desired amount and, if held as described, the bend cannot be noticed. Do not bend them as illustrated in Fig. 202, as they look badly.

The temples should then be trued with thumb and forefinger so that there will be no kinks in them; also that the straight part is perfectly straight and a natural curve to the tips. See that the temples curl the same way and as you hold the spectacle squarely in front of you with the temples curling toward you, each will be straight and not bent differently. If they are bent in this manner they do not fit the ears and also do not look well when the temples are closed. If the prescription calls for angular temples bend the endpieces, holding them with the No. 40 plier and with a snipe-nose plier tilt the joint the required amount. The temples are also brought into alignment in the same manner (Fig. 203). Do not bend the temples with hollow chop pliers so that they are all out of shape (Fig. 204). It should be noticed

if the temples fit well in the joints; if too loose they fall down, and this gives a very poor appearance to the job.

In frameless this can be regulated by the screw in the end-piece, but in frames the endpieces must be brought together

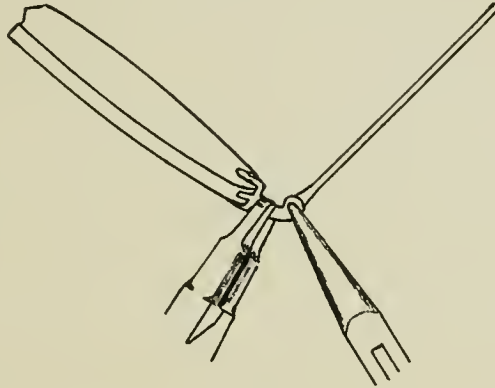

Fig. 203

better, and this is accomplished by removing the screw and the lens if desired, but this is unnecessary, as it can be held in the frame with one hand. With a pair of snipe-nose pliers in the right hand one endpiece is grasped and bent slightly towards the other. The screw is then replaced, and as the endpieces are



Fig. 204

brought together they bind on the outer end, so that the temple is held tightly.

When screwing the endpieces together be very careful that the dowel does not bind before it slips into the hole, as this will cause the endpieces to spread again. It is carelessness on the part of the grinder, when inserting the lenses in the frame, in allowing the dowel to strike against the opposite endpiece, thereby spreading them. This can be done either when pulling the end-

pieces together with pliers, or when inserting the screw. Gold-filled, especially, will not stand abuse in this manner.

The inspection is now complete and the lenses should be cleaned. In many places the inspectors simply breathe on the lenses and wipe them with a rag. This is not only unsanitary, but it does not clean the lenses properly. An atomizer containing water or some antiseptic mixture is much better, as the spray cleans around the straps and also leaves a polish on the lenses. A rubber atomizer is very convenient, as it can lie in any position on the table. Glass towels are the best for wiping lenses and if a clean one is used each day there will be no danger of scratching. The axis can then be dotted if they are to be sent out in this way.

The Refractive and Motor Mechanism of the Eye

By WILLIAM NORWOOD SOUTER, M.D.

Associate Ophthalmologist, Episcopal Eye, Ear
and Throat Hospital, Washington, D. C.

THIS work by one of the most eminent ophthalmologists in the United States, brings the science of eye refraction right up to date and embodies, in addition to the profound knowledge of the author, all the researches on the subject that experience has established as authoritative.

The geometric and mathematical optics on which the principles of optometry are based, *necessary information to optical students of to-day*, will be found in simplified form in the Appendix of this treatise.

Students, teachers and practitioners alike, in studying this book or using it for reference, have the assurance of absolute reliability of statement and complete elimination of the misleading fallacies which mar the worth of many works on this subject.

It contains 350 pages with 148 illustrations, many entirely original, and is probably the only scientific work ever published in which every single reference was verified absolutely by the author himself.

Sent postpaid to any part of the world on receipt of price

\$2.00 (8s. 4d.)



Published by

THE KEYSTONE PUBLISHING COMPANY

809-811-813 NORTH 19th STREET

PHILADELPHIA, U. S. A.

Physiologic Optics

Ocular Dioptrics --- Functions of the Retina --- Ocular Movements and Binocular Vision

By DR. M. TSCHERNING

Director of the Laboratory of Ophthalmology
at the Sorbonne, Paris



AUTHORIZED TRANSLATION

By CARL WEILAND, M.D.

Former Chief of Clinic in the Eye Department of the
Jefferson College Hospital, Philadelphia, Pa.

THIS book is recognized in the scientific and medical world as the one complete and authoritative treatise on physiologic optics. Its distinguished author is admittedly the greatest authority on this subject, and his book embodies not only his own researches, but those of the several hundred investigators who, in the past hundred years, made the eye their specialty and life study.

Tscherning has sifted the gold of all optical research from the dross, and his book, as now published in English, with many additions, is the most valuable mine of reliable optical knowledge within reach of ophthalmologists. It contains 380 pages and 212 illustrations, and its reference list comprises the entire galaxy of scientists who have made the century famous in the world of optics.

The chapters on Ophthalmometry, Ophthalmoscopy, Accommodation, Astigmatism, Aberration and Entoptic Phenomena, etc.—in fact, the entire book contains so much that is new, practical and necessary, that no refractionist can afford to be without it.

Bound in Cloth. 380 Pages, 212 Illustrations.
Sent postpaid to any part of the world on receipt of price

\$2.50 (10s. 5d.)



Published by

THE KEYSTONE PUBLISHING COMPANY

809-811-813 NORTH 19th STREET,
PHILADELPHIA, U. S. A.

Tests and Studies of the Ocular Muscles

By ERNEST E. MADDOX, M.D., F.R.C.S., Ed.

Ophthalmic Surgeon to the Royal Victoria Hospital, Bournemouth, England;
formerly Syme Surgical Fellow, Edinburgh University

THIS book is universally recognized as the standard treatise on the muscles of the eye, their functions, anomalies, insufficiencies, tests and optical treatment.

All opticians recognize that the subdivision of refractive work that is most troublesome is muscular anomalies. Even those who have mastered all the other intricacies of visual correction will often find their skill frustrated and their efforts nullified if they have not thoroughly mastered the ocular muscles.

The eye specialist can thoroughly equip himself in this fundamental essential by studying the work of Dr. Maddox, who is known in the world of medicine as the greatest investigator and authority on the subject of eye muscles.

The present volume is the second edition of the work, specially revised and enlarged by the author. It is copiously illustrated and the comprehensive index greatly facilitates reference.

Bound in Silk Cloth --- 261 Pages --- 110 Illustrations.
Sent postpaid to any part of the world on receipt of price

\$1.50 (6s. 3d)



Published by

THE KEYSTONE PUBLISHING COMPANY

809-811-813 NORTH 19th STREET
PHILADELPHIA, U. S. A.

The Principles of Refraction in the Human Eye, Based on the Laws of Conjugate Foci

By SWAN M. BURNETT, M.D., PH.D.

Formerly Professor of Ophthalmology and Otology in the Georgetown University Medical School; Director of the Eye and Ear Clinic, Central Dispensary and Emergency Hospital; Ophthalmologist to the Children's Hospital and to Providence Hospital, etc., Washington, D. C.

IN this treatise the student is given a condensed but thorough grounding in the principles of refraction according to a method which is both easy and fundamental. The few laws governing the conjugate foci lie at the basis of whatever pertains to the relations of the object and its image.

To bring all the phenomena manifest in the refraction of the human eye consecutively under a common explanation by these simple laws is, we believe, here undertaken for the first time. The comprehension of much which has hitherto seemed difficult to the average student has thus been rendered much easier. This is especially true of the theory of Skiascopy, which is here elucidated in a manner much more simple and direct than by any method hitherto offered.

The authorship is sufficient assurance of the thoroughness of the work. Dr. Burnett was recognized as one of the greatest authorities on eye refraction, and this treatise may be described as the crystallization of his life-work in this field.

The text is elucidated by 24 original diagrams, which were executed by Chas. F. Prentice, M.E., whose pre-eminence in mathematical optics is recognized by all ophthalmologists.

BOUND IN SILK CLOTH

Sent postpaid to any part of the world on receipt of price

\$1.00 (4s. 2d.)



Published by

THE KEYSTONE PUBLISHING COMPANY

809-811-813 NORTH 19th STREET
PHILADELPHIA, U. S. A.

Ophthalmic Lenses

Dioptric Formulæ for Combined Cylindrical Lenses, The Prism-Dioptry and Other Original Papers

By CHARLES F. PRENTICE, M.E.

A new and revised edition of all the original papers of this noted author, combined in one volume. In this revised form, with the addition of recent research, these standard papers are of increased value. Combined in one volume, they are the greatest compilation on the subject of lenses extant.

This book of over 200 pages contains the following papers:

Ophthalmic Lenses.
Dioptric Formulæ for Combined Cylindrical Lenses.
The Prism-Dioptry.
A Metric System of Numbering and Measuring Prisms.
The Relation of the Prism-Dioptry to the Meter Angle.
The Relation of the Prism-Dioptry to the Lens-Dioptry.
The Perfected Prismometer.
The Prismometric Scale.
On the Practical Execution of Ophthalmic Prescriptions involving Prisms.
A Problem in Cemented Bi-Focal Lenses, Solved by the Prism-Dioptry.
Why Strong Contra-Generic Lenses of Equal Power Fail to Neutralize Each Other.
The Advantages of the Sphero-Toric Lens.
The Iris, as Diaphragm and Photostat.
The Typoscope.
The Correction of Depleted Dynamic Refraction (Preshyopia).

PRESS NOTICES OF THE ORIGINAL EDITION: OPHTHALMIC LENSES

"The work stands alone, in its present form, a compendium of the various laws of physics relative to this subject that are so difficult of access in scattered treatises."
—*New England Medical Gazette*.

"It is the most complete and best illustrated book on this special subject ever published."
—*Horological Review, New York*.

"Of all the simple treatises on the properties of lenses that we have seen, this is incomparably the best. . . . The teacher of the average medical student will hail this little work as a great boon."
—*Archives of Ophthalmology, edited by H. Knapp, M.D.*

Bound in Silk Cloth. 110 Original Diagrams.
Sent postpaid to any part of the world on receipt of price

\$1.50 (6s. 3d.)



Published by
THE KEYSTONE PUBLISHING COMPANY
809-811-813 NORTH 19th STREET
PHILADELPHIA, U. S. A.

The Optician's Manual

Volume I.

By C. H. BROWN, M. D.

Graduate University of Pennsylvania; Professor of Principles and Practice of Optometry; formerly Physician to the Philadelphia Hospital; Author of "Clinics in Optometry," etc.

THE OPTICIAN'S MANUAL, Vol. I, was the most popular and useful work on practical refraction ever written, and has been the entire optical education of many hundred successful refractionists. The knowledge it contains was more effective in building up the profession of optometry than any other educational factor. It is, in fact, the foundation structure of all optometric knowledge as the titles of its ten chapters show:

- Chapter I.—Introductory Remarks.
- Chapter II.—The Eye Anatomically.
- Chapter III.—The Eye Optically; or,
The Physiology of Vision.
- Chapter IV.—Optics.
- Chapter V.—Lenses.
- Chapter VI.—Numbering of Lenses.
- Chapter VII.—The Use and Value of Glasses.
- Chapter VIII.—Outfit Required.
- Chapter IX.—Method of Examination.
- Chapter X.—Presbyopia.

In its present revised and enlarged form this volume is the recognized standard text-book on practical refraction, being used as such in all schools of Optics. A study of it is essential to an intelligent appreciation of its companion treatise, The Optician's Manual, Vol. II. A comprehensive index adds much to its usefulness to both student and practitioner.

Bound in cloth—422 pages—colored plates and illustrations.
Sent postpaid to any part of the world on receipt of price

\$1.50 (6s. 3d.)

Published by

THE KEYSTONE PUBLISHING COMPANY
809-811-813 NORTH 19th STREET
PHILADELPHIA, U. S. A.

The Optician's Manual

VOL. II.

By C. H. BROWN, M.D.

Graduate University of Pennsylvania; Professor of Optics and Refraction;
Formerly Physician in Philadelphia Hospital; Author of "Clinics in
Optometry"; "State Board Questions and Answers"; Etc.

THE Optician's Manual, Vol. II., is a direct continuation of The Optician's Manual, Vol. I., being a much more advanced and comprehensive treatise. It covers in minutest detail the four great subdivisions of practical eye refraction, viz :

MYOPIA
HYPERMETROPIA
ASTIGMATISM
MUSCULAR ANOMALIES

It contains the most authoritative and complete researches up to date on these subjects, treated by the master hand of an eminent oculist and optical teacher. It is thoroughly practical, explicit in statement and accurate as to fact. All refractive errors and complications are clearly explained, and the methods of correction thoroughly elucidated.

This book fills the last great want in higher refractive optics, and the knowledge contained in it marks the standard of professionalism.

Bound in Cloth. 408 pages, with illustrations.
Sent postpaid to any part of the world on receipt of price

\$1.50 (6s. 3d.)

Published by
THE KEYSTONE PUBLISHING COMPANY
809-811-813 NORTH 19th STREET
PHILADELPHIA, U. S. A.

Clinics in Optometry

By C. H. BROWN, M. D.

Graduate University of Pennsylvania; Professor of Principles and Practice of Optometry; formerly Physician to the Philadelphia Hospital; Author of the Optician's Manual, Etc.

“CLINICS IN OPTOMETRY” is a unique work in the field of practical refraction and fills a want that has been seriously felt both by oculists and optometrists.

The book is a compilation of optometric clinics, each clinic being complete in itself. Together they cover all manner of refractive eye defects, from the simplest to the most complicated, giving in minutest detail the proper procedure to follow in the diagnosis, treatment and correction of all such defects.

Practically every case that can come before you is thoroughly explained in all its phases in this useful volume, making mistakes or oversights impossible and assuring correct and successful treatment.

The author's experience in teaching the science of refraction to thousands of pupils peculiarly equipped him for compiling these clinics, all of which are actual cases of refractive error that came before him in his practice as an oculist.

A copious index makes reference to any particular case, test or method, the work of a moment.

BOUND IN SILK CLOTH

Sent postpaid to any part of the world on receipt of price

\$1.50 (6s. 3d.)



Published by

THE KEYSTONE PUBLISHING COMPANY

809-811-813 NORTH 19th STREET
PHILADELPHIA, U. S. A.

State Board Examinations

QUESTIONS and ANSWERS

By C. H. BROWN, M. D.
(University of Pennsylvania '78)

Formerly Physician Philadelphia Hospital; Professor Principles
and Practice of Optometry; Author The Optician's Manual,
Volumes I and II; Clinics in Optometry; etc., etc.

THIS volume was specially compiled for the guidance and instruction of candidates for examination before optometry boards and for optical students generally. It contains five hundred questions with answers, the questions being carefully selected from the examination papers set by the State Boards of Examiners in Optometry.

The book was compiled to meet the needs of those who may find it compulsory or advisable to take a State Board examination, and for optical students generally.

The questions are probably more fully answered than a State examining board would expect, the idea being to give complete information on the special subject brought out by each question.

The contents are classified under different headings, which gives the work the character of a text-book and facilitates study and reference.

As the questions were selected with a view to avoiding repetition, the book will be found to cover thoroughly every paper set by any of the State Examining Boards.

BOUND IN SILK CLOTH

Sent postpaid to any part of the world on receipt of price

\$1.00 (4s. 2d.)



Published by
THE KEYSTONE PUBLISHING COMPANY
809-811-813 NORTH 19th STREET
PHILADELPHIA, U. S. A.

Record-Book of Optometric Examinations

A RECORD-BOOK, wherein to record optometric examinations, is an indispensable adjunct to an optometrist's outfit.

The Keystone Record-Book of Optometric Examinations was specially prepared for this purpose. It excels all others in being not only a record-book, but an invaluable guide in examination.

The book contains two hundred record forms with printed headings, suggesting, in the proper order, the course of examination that should be pursued to obtain most accurate results.

Each book has an index, which enables the optometrist to refer instantly to the case of any particular patient.

The Keystone Record-Book diminishes the time and labor required for examinations, obviates possible oversights from carelessness, and assures a systematic and thorough examination of the eye, as well as furnishes a permanent record of all examinations.

Sent postpaid to any part of the world on receipt of price

\$1.00 (4s. 2d.)



Published by

THE KEYSTONE PUBLISHING COMPANY

809-811-813 NORTH 19th STREET

PHILADELPHIA, U. S. A.

This book is DUE on the last date stamped below.

--	--	--

